



AUTOCARRI & BUS
TRUCKS & BUSES
LKW & BUSSE
CAMIONS ET AUTOBUS
CAMIONES Y AUTOBUSES



INDICE - CONTENTS - INDEX - INDICE - ÍNDICE

DESCRIZIONE - DESCRIPTION - BESCHREIBUNG DESCRIPTION - DESCRIPCIÓN	PAGINA - PAGE SEITE - PAGE PÁGINA
INDICE - CONTENTS - INDEX - INDICE - ÍNDICE	2
UTILIZZO DEL CATALOGO - HOW TO USE THE CATALOGUE ANLEITUNG ZUR VERWENDUNG DES KATALOGS COMMENT UTILISER LE CATALOGUE CÓMO USAR EL CATÁLOGO	3
IMMAGINI - DIMENSIONI - IMAGES - DIMENSIONS ABBILDUNGEN - ABMESSUNGEN - IMAGES DIMENSIONS - IMÁGENES - DIMENSIONES	4
<hr/>	
VEICOLI COMMERCIALI - LCV VEHICLE	7
ASTRA	75
DAF	76
FIAT - OM	102
IVECO	108
MAN	148
MERCEDES	178
NISSAN	233
RENAULT V.I.	236
SCANIA	264
VOLVO	288
BREDAMENARINIBUS	325
DAF BUS	328
IVECO BUS	329
MAN BUS	342
MERCEDES BUS	359
NEOPLAN BUS	384
RENAULT V.I. BUS	396
SCANIA BUS	404
VOLVO BUS	415
<hr/>	
CORRISPONDENZE CODICI - CROSS REFERENCES QUERVERWEISE - RÉFÉRENCES CROISÉES - REFERENCIAS CRUZADAS:	
CODICE ORIGINALE > CODICE OCAP ORIGINAL REFERENCE > OCAP REFERENCE ORIGINALREFERENZ > OCAP-REFERENZ	429
RÉFÉRENCE ORIGINALE > RÉFÉRENCE OCAP REFERENCIA ORIGINAL > REFERENCIA OCAP	
CODICE OCAP > CODICE ORIGINALE OCAP REFERENCE > ORIGINAL REFERENCE OCAP-REFERENZ > ORIGINALREFERENZ	455
RÉFÉRENCE OCAP > RÉFÉRENCE ORIGINALE REFERENCIA OCAP > REFERENCIA ORIGINAL	

**UTILIZZO DEL CATALOGO - HOW TO USE THE CATALOGUE
ANLEITUNG ZUR VERWENDUNG DES KATALOGS
COMMENT UTILISER LE CATALOGUE - CÓMO USAR EL CATÁLOGO**



OCAP GROUP VEICOLI COMMERCIALI - LCV VEHICLE 1

MERCEDES - T2/LN1 (507 > 814) - 1986 > 2

RIF. OCAP OCAP REF.	RIF. ORIG O.E. NUMBER	NOTE REMARKS	MODELLO / DESCRIZIONE MODEL / DESCRIPTION
0180727  3	6013305335 6013300435 6013300635 6013305335 4	L=96 M=20x1,5 RHT 5	TESTA STERZO - TIE ROD END - MOD.: 607-608-610 6
0190727 	6013305235 6013300535 6013300735 6013305235	L=96 M=20x1,5 LHT	TESTA STERZO - TIE ROD END - MOD.: 607-608-610
0507653  0186612 M=24x1,5 RHT 0196612 M=24x1,5 LHT 7	6703300303 6693300403 6693300503 6703300003 6703300103 6703300203 6703300303 6883300003 6883300103	L=1694 T=35	BARRA STERZO - TIE ROD - MOD.: 607-608-610 - 6090-6110-7090-7110-7140-8090 - 8110-8140

OCAP GROUP IVECO 1

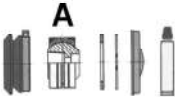
BARRE DI REAZIONE - TORQUE RODS 2

RIF. OCAP OCAP REF.	RIF. ORIG O.E. NUMBER	NOTE REMARKS	MODELLO / DESCRIZIONE MODEL / DESCRIPTION
0807296  3 A 7 B 7	41028599 41028599 41042092 41022092 98472468 4	L=665 d=21 5	EUROCARGO: - 120E16/E18/E23 - 130E15/18/E23/E24 - 150E16/E18/E23/E27 - 170E18/E23/E27 - 280E23-280E23-320E27 - EUROTECH: - 100E24E27E30E34 - 190E24E27E30 - 325E27-400E24/E30 - TECTOR: - 130E28-150E18/E24 - 150E24-180E21/E24/E28 - 320E28 6
0907297  7 A 7	93161958 93161958 93162239	D=65 IK=38	
0907327  7 B 7	93192361 93192361	l=130 p=24 D=62 d=19	

N.	ITA	GB	DEU	FRA	ESP
[1]	MARCA TIPO VEICOLO	BRAND VEHICLE TYPE	MARKE FAHRZEUGTYP	MARQUE TYPE DE VÉHICULE	MARCA TIPO DE VEHÍCULO
[2]	MODELLO GAMMA PRODOTTO	MODEL PRODUCT RANGE	MODELL PRODUKTPALETTE	MODÈLE GAMME DE PRODUITS	MODELO GAMA DE PRODUCTOS
[3]	CODICE OCAP	OCAP REFERENCE	OCAP-REFERENZ	RÉFÉRENCE OCAP	REFERENCIA OCAP
[4]	CODICE ORIGINALE	O.E. REFERENCE	O.E. REFERENZ	RÉFÉRENCE O.E.	REFERENCIA O.E.
[5]	NOTE	NOTES	ANMERKUNGEN	NOTES	NOTAS
[6]	MODELLI DESCRIZIONE	MODELS DESCRIPTIONS	MODELLE BESCHREIBUNGEN	MODÈLES DESCRIPTIONS	MODELOS DESCRIPCIONES
[7]	COMPONENTI	COMPONENTS	KOMPONENTEN	COMPOSANTS	COMPONENTES



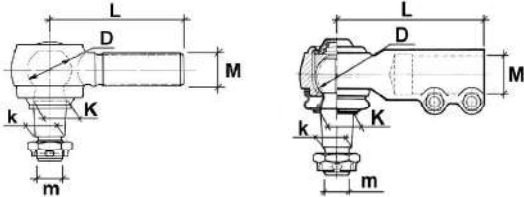
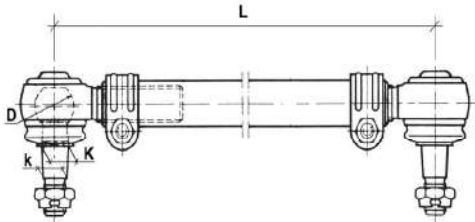
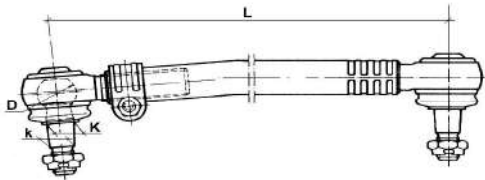
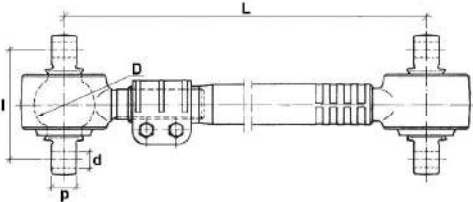

**IMMAGINI - DIMENSIONI - IMAGES - DIMENSIONS
 ABBILDUNGEN - ABMESSUNGEN - IMAGES - DIMENSIONS - IMÁGENES - DIMENSIONES**

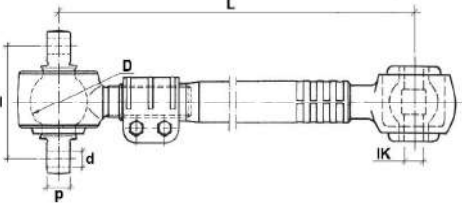
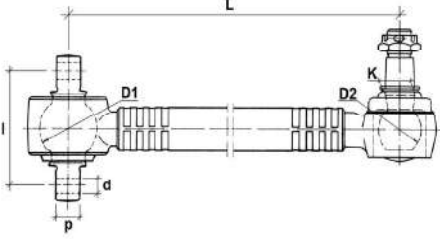
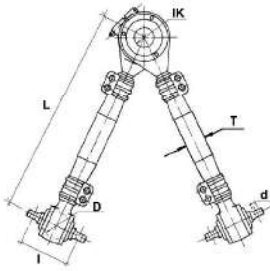
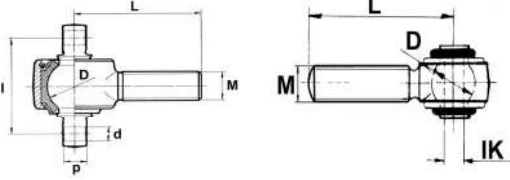
<p>IMMAGINE / IMAGE / BILD IMAGE / IMAGEN</p>	<p>DIMENSIONI / SIZE / ABMESSUNGEN DIMENSIONS / DIMENSIONES</p>
<p>TESTA STERZO / TIE ROD END / KUGELGELENK ROTULE DE DIRECTION / RÓTULA DE DIRECCIÓN</p> 	<p>M = Filettatura gambo - Stem Thread - Gewinde am schaft Filetage de tige - Rosca en el vástago m = Filettatura del perno - Pin thread - Schaftgewinde Filetage de l'axe - Hilo de alfiler L = Lunghezza testa sterzo - Tie rod end length - Lenkkopflänge Longueur de la tête de direction Longitud del rótula de dirección D = Diametro sfera - Ball pin diameter - Kugelbolzendurchmesser Diamètre de la sphère - Diámetro de l'axe de bola K = Diametro cono base perno - Taper diameter max. size Durchmesser des Basiskegels des Stifts Diamètre du cône a la base de l'axe Diámetro del cono base de l'axe k = Diametro cono inizio perno - Taper diameter min. size Durchmesser des Kegels am Anfang des Stifts Diamètre du cône au début de l'axe Diámetro del cono al inicio de l'axe</p>
<p>BARRA ACCOPIAMENTO / TIE ROD VERBINDUNGSSTAB / BARRE D'ACCOUPEMENT BARRA DE ACOPLAMIENTO</p> 	<p>L = Lunghezza barra accoppiamento - Tie rod length - Spurstangenlänge Longueur de la barre d'accouplement Longitud de la barra de acoplamiento D = Diametro sfera - Ball pin diameter - Kugelbolzendurchmesser Diamètre de la sphère - Diámetro del pasador de bola K = Diametro cono base perno - Taper diameter max. size Durchmesser des Basiskegels des Stifts Diamètre du cône a la base de l'axe Diámetro del cono base del pasador k = Diametro cono inizio perno - Taper diameter min. size Durchmesser des Kegels am Anfang des Stifts Diamètre du cône au début de l'axe Diámetro del cono al inicio de l'axe</p>
<p>TIRANTE LONGITUDINALE / DRAG LINK VERBINDUNGSSTANGE / BARRES LONGITUDINALES TIRANTE LONGITUDINAL</p> 	<p>L = Lunghezza tirante - Drag link length - Länge des längslenker Longueur de la biellette de direction - Longitud de la barra D = Diametro sfera - Ball pin diameter - Kugelbolzendurchmesser Diamètre de la goupille à bille - Diámetro del pasador de bola K = Diametro cono base perno - Taper diameter max. size Durchmesser des Basiskegels des Stifts Diamètre du cône de base de la goupille Diámetro del cono base de l'axe k = Diametro cono inizio perno - Taper diameter min. size Durchmesser des Kegels am Anfang des Stifts Diamètre du cône au début de la broche Diámetro del cono al inicio de l'axe</p>
<p>BARRA DI REAZIONE / TORQUE ROD REAKTIONSTANGE / BARRE DE RÉACTION BARRA DE REACCIÓN</p> 	<p>L = Lunghezza barra di reazione - Torque rod length Drehmomentstangenlänge - Longueur de la barre de réaction Longitud de la barra de reacción D = Diametro sfera - Ball pin diameter - Kugeldurchmesser Diamètre de la sphère - Diámetro de la esfera d = Diametro foro perno - Hole pin diameter - Stiftlochdurchmesser Diamètre du trou de l'axe - Diámetro del orificio de l'axe p = Spessore perno - Thickness of the pin - Stiftdicke Épaisseur de l'axe - Grosor del pasador I = Interasse fori perno - Pin hole spacing Abstand der Drehpunktbohrung Entraxe des trous de l'axe Distancia entre centros del orificio del pivote</p>

**IMMAGINI - DIMENSIONI - IMAGES - DIMENSIONS
 ABBILDUNGEN - ABMESSUNGEN - IMAGES - DIMENSIONS - IMÁGENES - DIMENSIONES**

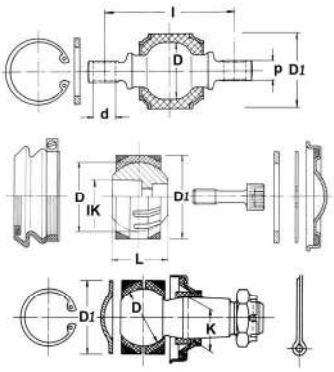
<p align="center">IMMAGINE / IMAGE / BILD IMAGE / IMAGEN</p>	<p align="center">DIMENSIONI / SIZE / ABMESSUNGEN DIMENSIONS / DIMENSIONES</p>
<p align="center"> BARRA DI REAZIONE / TORQUE ROD REAKTIONSTANGE / BARRE DE RÉACTION BARRA DE REACCIÓN </p> 	<p> L = Lunghezza barra di reazione - Torque rod length Drehmomentstangenlänge - Longueur de la barre de réaction Longitud de la barra de reacción D = Diametro sfera - Ball pin diameter - Kugelbolzendurchmesser Diamètre de la sphère - Diámetro del pasador de bola d = Diametro foro perno - Hole pin diameter - Stiftlochdurchmesser Diamètre du trou de l'axe - Diámetro del orificio de l'axe p = Spessore perno - Thickness of the pin - Stiftdicke Épaisseur de l'axe - Grosor de l'axe I = Interasse fori perno - Pin hole spacing Abstand der Drehpunktbohrung Entraxe des trous de l'axe Distancia entre centros del orificio del pivote IK = Diametro foro sfera - Hole ball pin diameter - Kugellochdurchmesser Diamètre du trou de bille - Diámetro del orificio de la bola </p>
<p align="center"> BARRA DI REAZIONE / TORQUE ROD REAKTIONSTANGE / BARRE DE RÉACTION BARRA DE REACCIÓN </p> 	<p> L = Lunghezza barra di reazione - Torque rod length Drehmomentstangenlänge - Longueur de la barre de réaction Longitud de la barra de reacción D1 / D 2 = Diametro sfera - Ball pin diameter - Kugeldurchmesser Diamètre de la sphère - Diámetro de la esfera K = Diametro cono base perno - Taper diameter max. size Durchmesser des Basiskegels des Stifts Diamètre du cône a la base de l'axe Diámetro del cono base de l'axe d = Diametro foro perno - Hole pin diameter - Stiftlochdurchmesser Diamètre du trou de l'axe - Diámetro del orificio de l'axe p = Spessore perno - Thickness of the pin - Stiftdicke Épaisseur de l'axe - Grosor de l'axe I = Interasse fori perno - Pin hole spacing Abstand der Drehpunktbohrung Entraxe des trous de l'axe Distancia entre centros del orificio del pivote </p>
<p align="center"> BARRA DI REAZIONE TRIANGOLARE / TRIANGULAR TORQUE ROD DREIECKIGE REAKTIONSTANGE BARRE DE RÉACTION TRIANGULAIRE BARRA DE REACCIÓN TRIANGULAR </p> 	<p> L = Lunghezza barra di reazione - Torque rod length Drehmomentstangenlänge - Longueur de la barre de réaction Longitud de la barra de reacción D = Diametro sfera - Ball pin diameter - Kugeldurchmesser Diamètre de la sphère - Diámetro de la esfera d = Diametro foro perno - Hole pin diameter - Stiftlochdurchmesser Diamètre du trou de l'axe - Diámetro del orificio de l'axe p = Spessore perno - Thickness of the pin - Stiftdicke Épaisseur de la broche - Grosor de l'axe I = Interasse fori perno - Pin hole spacing Abstand der Drehpunktbohrung IK = Diametro foro sfera - Hole ball pin diameter - Kugellochdurchmesser Diamètre du trou de bille - Diámetro del orificio de la bola T = Diametro tubo - Tube diameter - Rohrdurchmesser Diamètre du tuyau - Diámetro de la tubería </p>
<p align="center"> TESTA BARRA DI REAZIONE / TORQUE ROD JOINT REAKTIONSTANGENKOPF ARTICULATION À BARRE DE RÉACTION JUNTA DE BARRA DE REACCIÓN </p> 	<p> L = Lunghezza testa - Ball joint length - Kugelgelenklänge Longueur de la rotule M = Filetto gambo testa - Head shank thread - Kopschaftgewinde Filetage de la tige de la tête - Rosca del vástago de la cabeza D = Diametro sfera - Ball pin diameter - Kugeldurchmesser Diamètre de la sphère - Diámetro de la esfera d = Diametro foro perno - Hole pin diameter - Stiftlochdurchmesser Diamètre du trou d'épingle - Diámetro del orificio de l'axe p = Spessore perno - Thickness of the pin - Stiftdicke Épaisseur de la broche - Grosor de l'axe I = Interasse fori perno - Pin hole spacing Abstand der Drehpunktbohrung IK = Diametro foro sfera - Hole ball pin diameter - Kugellochdurchmesser Diamètre du trou de bille - Diámetro del orificio de la bola </p>

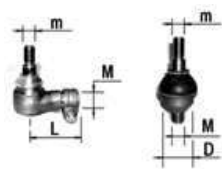







**IMMAGINI - DIMENSIONI - IMAGES - DIMENSIONS
ABBILDUNGEN - ABMESSUNGEN - IMAGES - DIMENSIONS - IMÁGENES - DIMENSIONES**

<p>IMMAGINE / IMAGE / BILD IMAGE / IMAGEN</p>	<p>DIMENSIONI / SIZE / ABMESSUNGEN DIMENSIONS / DIMENSIONES</p>
<p>KIT DI RIPARAZIONE / REPAIRING KIT / REPARATURSATZ KIT DE REPARATION / JUEGO DE REPARACIÓN</p> 	<p>D = Diametro sfera - Ball pin diameter - Kugeldurchmesser Diamètre de la sphère - Diámetro de la esfera D1 = Diametro kit - Kit diameter - Kit-Durchmesser Diamètre du kit - Diámetro del kit d = Diametro foro perno - Hole pin diameter - Stiftlochdurchmesser Diamètre du trou d'épingle - Diámetro del orificio de l'axe p = Spessore perno - Thickness of the pin - Stiftdicke Épaisseur de la broche - Grosor del pasador l = nterasse fori perno - Pin hole spacing Abstand der Drehpunktbohrung K = Diametro cono base perno - Taper diameter max. size Durchmesser des Basiskegels des Stifts Diamètre du cône de base de la goupille Diámetro del cono base del pasador IK = Diametro foro sfera - Hole ball pin diameter - Kugellochdurchmesser Diamètre du trou de bille - Diámetro del orificio de la bola L = Lunghezza sfera - Ball pin length - Kugellänge - Longueur de la sphère Longitud de la esfera</p>
<p>SNODO ASSIALE / AXIAL JOINT / AXIALGELENK ROTULE AXIALE / RÓTULA AXIAL</p> 	<p>L = Lunghezza snodo assiale - Axial joint length - Länge des axialen Gelenks - Longueur du pivot axiale Longitud de la junta axial M = Filettatura del perno - Pin thread - Schaftgewinde Filetage de l'axe - Hilo de alfiler m = Filetto corpo - Shape thread - Formfaden Filetage du corp - Hilo de forma</p>
<p>SNODO SOSPENSIONE / BALL JOINT FUEHRUNGSGELENK / ROTULE DE SUSPENSION RÓTULA DE SUSPENSIÓN</p> 	<p>M = Filetto snodo sospensione - Ball joint thread - Kugelgelenkgewinde Filetage de la rotule - Rosca de rótula m = Filettatura del perno - Pin thread - Schaftgewinde Filetage de l'axe - Hilo de alfiler L = Lunghezza da centro testa a fine gambo - Length from head center to end of stick Länge von der Mitte des Kopfes bis zum Ende des Stocks Longueur du centre de la tête jusqu'à l'extrémité du bâton Longitud desde el centro de la cabeza hasta el extremo del palo</p>
<p>BRACCIO OSCILLANTE / TRACK CONTROL ARM QUERLENKER / BRAS DE SUSPENSION BRAZO DE SUSPENSIÓN</p> 	
<p>STABILIZZATORE / STABILIZER LINK / STABILISATOR BIELLETTE STABILISATRICE / BIELETA ESTABILIZADORA</p> 	<p>L = Lunghezza stabilizzatore - Stabilizer link length Stabilisatorverbindungslänge Longueur de la biellette de barre stabilisatrice Longitud del enlace estabilizador m = Filettatura del perno - Pin thread - Schaftgewinde Filetage de l'axe - Hilo de alfiler T = Diametro tubo - Tube diameter - Rohrdurchmesser Diamètre du tube - Diámetro del tubo D1 / D2 = Diametro foro perno - Hole pin diameter Stiftlochdurchmesser - Diamètre du trou d'épingle Diámetro del orificio de l'axe H = Altezza, spessore - Height, thickness - Höhe, Dicke Hauteur, épaisseur - Altura, grosor</p>

CITROEN - JUMPER - C25 - 1994 > 2006

RIF. OCAP OCAP REF.	RIF. ORIG O.E. NUMBER	NOTE REMARKS	MODELLO / DESCRIZIONE MODEL / DESCRIPTION
0281143 	1471655080 1306716080 1471655080 4018A3 4018H4	M=16x1,5 RHT	TESTA STERZO - TIE ROD END - > 12/2002
0282323 	77362278 77362278 4018E0	M=16x1,5 RHT	TESTA STERZO - TIE ROD END - 01/2003 >
0601139 	4018A4 1471654080 400624 4018A4 9945836	M=16x1,5 RHT	SNODO ASSIALE - AXIAL JOINT
0900489 	400622 9946982 400622 401815		KIT CUFFIA STERZO - STERZO MANUALE - KIT STEERING BOOT - MANUAL STEERING
1211310 	4018A52 9946982 4018A5		CUFFIA STERZO - SERVOSTERZO - STEERING BOOT - POWER STEERING
0900449 	406635 9945837 406635		KIT CUFFIE STERZO - SERVOSTERZO - KIT STEERING BOOTS - POWER STEERING
0401137 	1302368080 1302368080 3640.32 364032		SNODO SOSPENSIONE - BALL JOINT - MOD. 1.0 - 1.4 t. > 01/ 2001
0381141 	1320787080 1308601080 1317241080 1320787080 352165 3521.65		BRACCIO OSCILLANTE - TRACK CONTROL ARM - MOD. 1.0 - 1.4 t. - > 01/2001
0391141 	1320786080 1308600080 1317240080 1320786080 352095 3520.95		BRACCIO OSCILLANTE - TRACK CONTROL ARM - MOD. 1.0 - 1.4 t. - > 01/2001









CITROEN - JUMPER - C25 - 1994 > 2006

RIF. OCAP OCAP REF.	RIF. ORIG O.E. NUMBER	NOTE REMARKS	MODELLO / DESCRIZIONE MODEL / DESCRIPTION
0401446 	1331640080 1331640080 364055 3640.55		SNODO SOSPENSIONE - BALL JOINT - MOD. 1.0 - 1.4 t. - 02/2001 >
0381446 	1331940080 1339467080 1331940080 3521J3 3521.J3		BRACCIO OSCILLANTE - TRACK CONTROL ARM - MOD. 1.0 - 1.4 t. - 02/2001 >
0391446 	1331938080 1339465080 1331938080 3520N3 3520.N3		BRACCIO OSCILLANTE - TRACK CONTROL ARM - MOD. 1.0 - 1.4 t. - 02/2001 >
0401138 	1300473080 1300473080 364033 3640.33		SNODO SOSPENSIONE - BALL JOINT - MOD. 1.8 t - > 01/2001
0381140 	1320756080 1308760080 1317239080 1320756080 352166 3521.66		BRACCIO OSCILLANTE - TRACK CONTROL ARM - MOD. 1.8 t - > 01/2001
0391140 	1320755080 1320755080 1317238080 1308759080 352096 3520.96		BRACCIO OSCILLANTE - TRACK CONTROL ARM - MOD. 1.8 t - > 01/2001
0401451 	1331641080 1331641080 364054 3640.54		SNODO SOSPENSIONE - BALL JOINT - MOD. 1.8 t - 02/2001 >
0381451 	1331939080 1339466080 1331939080 3521J4 3521.J4		BRACCIO OSCILLANTE - TRACK CONTROL ARM - MOD. 1.8 t - 02/2001 >









CITROEN - JUMPER - C25 - 1994 > 2006

RIF. OCAP OCAP REF.	RIF. ORIG O.E. NUMBER	NOTE REMARKS	MODELLO / DESCRIZIONE MODEL / DESCRIPTION
0391451 	1331937080 1339464080 1331937080 3520N4 3520.N4		BRACCIO OSCILLANTE - TRACK CONTROL ARM - MOD. 1.8 t - 02/2001 >
1215176 	- -		SILENTBLOC CENTRALE - CENTRAL BUSHING
1215177 	- -		SILENTBLOC ESTREMO - OUTER BUSHING
0181602 	1300716080 1300716080		PUNTONE BARRA STABILIZZATRICE - STABILIZER LINK
0181602-K 	- 1300716080 15503811 1300721080 1300720080		KIT PUNTONE BARRA STABILIZZATRICE - STABILIZER LINK KIT
0282637 	381770 381770 77364009	M=16x1,5 RHT	TESTA STERZO - TIE ROD END
0292637 	381777 381777 77364253	M=16x1,5 RHT	TESTA STERZO - TIE ROD END
0602637 	4000SF * 4000SF * 4000SG * 1341019080 * 1345854080 *	M=16x1,5 RHT	SNODO ASSIALE - AXIAL JOINT
0902637 	406686 406686 77364254		KIT CUFFIA STERZO - STEERING BOOT KIT
0402638 	364067 364067 50705629		SNODO SOSPENSIONE - ASSE ANTERIORE - BALL JOINT - FRONT AXLE - MOD. Q11-Q15-Q17L-Q17Q-Q20









CITROEN - JUMPER - 2006 >

RIF. OCAP OCAP REF.	RIF. ORIG O.E. NUMBER	NOTE REMARKS	MODELLO / DESCRIZIONE MODEL / DESCRIPTION
0382638 	3521P1 3521P1 1352225080		BRACCIO OSCILLANTE - ASSE ANTERIORE - INFERIORE - TRACK CONTROL ARM FRONT AXLE - LOWER - MOD. Q11- Q15-Q17L
0392638 	3520S0 3520S0 1352227080		BRACCIO OSCILLANTE - ASSE ANTERIORE - INFERIORE - TRACK CONTROL ARM FRONT AXLE - LOWER - MOD. Q11- Q15-Q17L
0382639 	3521P2 3521P2 1352226080		BRACCIO OSCILLANTE - ASSE ANTERIORE - INFERIORE - TRACK CONTROL ARM FRONT AXLE - LOWER - MOD. Q17H- Q20
0392639 	3520S1 3520S1 1352228080		BRACCIO OSCILLANTE - ASSE ANTERIORE - INFERIORE - TRACK CONTROL ARM FRONT AXLE - LOWER - MOD. Q17H- Q20
1215822 	- -		SILENTBLOC CENTRALE - CENTRAL BUSHING
1215823 	- -		SILENTBLOC ESTREMO - OUTER BUSHING
0182638 	5081N9 Z 1350658080 Z 1357572080 Z 5081N9 Z		STABILIZZATORE - ASSE ANTERIORE - STABILIZER LINK - FRONT AXLE
0503520 	1355449080 Z 1355449080 Z		STABILIZZATORE - ASSE POSTERIORE - STABILIZER LINK - REAR AXLE
0280037 	405909 405909 9404059080 1306003080 4322906 3265974	M=14x1,5 RHT	TESTA STERZO - TIE ROD END

CITROEN - JUMPY - 1995 > 2006

RIF. OCAP OCAP REF.	RIF. ORIG O.E. NUMBER	NOTE REMARKS	MODELLO / DESCRIZIONE MODEL / DESCRIPTION
0600918 	3812A4 3812A4 9566950880	M=14x1,5 RHT	SNODO ASSIALE - AXIAL JOINT
0381184 	352164 71737048 1313084080 1333755080 1322664080 1317390080 1316736080		BRACCIO OSCILLANTE - TRACK CONTROL ARM
0391184 	352094 71737047 1313083080 1333754080 1322663080 1317389080 1316735080		BRACCIO OSCILLANTE - TRACK CONTROL ARM
1215173 	- -		SILENTBLOCK CENTRALE - CENTRAL BUSHING
1215174 	- -		SILENTBLOCK ESTREMO - DX - OUTER BUSHING - RH
1215175 	- -		SILENTBLOCK ESTREMO - SX - OUTER BUSHING - LH
0181322-K 	508735 * 1308664080 * 15503811 * 1311025080 * 1313056080 * 508735 *		KIT PUNTONE BARRA STABILIZZATRICE - STABILIZER LINK KIT
0181322 	508735 508735		PUNTONE BARRA STABILIZZATRICE - STABILIZER LINK
0282733 	381773 381773 9403817738	M=14x1,5 RHT	TESTA STERZO - TIE ROD END
0602733 	3812F0 3812F0 1497552080 1401381380	M=14x1,5 RHT	SNODO ASSIALE STERZO - AXIAL JOINT











CITROEN - JUMPY - 2007 >

RIF. OCAP OCAP REF.	RIF. ORIG O.E. NUMBER	NOTE REMARKS	MODELLO / DESCRIZIONE MODEL / DESCRIPTION
1211477 	406683 * 406683 * 9404066838 *		CUFFIA STERZO - STEERING GAITER
0902733 	406683 406683 9404066838		KIT CUFFIA STERZO - STEERING GAITER KIT
0382734 	3521N9 3521N9 1497407080		BRACCIO OSCILLANTE - TRACK CONTROL ARM
0392734 	3520R8 3520R8 1497408080		BRACCIO OSCILLANTE - TRACK CONTROL ARM
1215646 	-		SILENTBLOCK ESTREMO - DX - OUTER BUSHING - RH
1215647 	-		SILENTBLOCK ESTREMO - SX - OUTER BUSHING - LH
1215870 	-		SILENTBLOCK CENTRALE - CENTRAL BUSHING
0502735 	508756 508756 1400099680		STABILIZZATORE - ASSE ANTERIORE - STABILIZER LINK - FRONT AXLE









FIAT - DUCATO - TALENTO - > 1994

RIF. OCAP OCAP REF.	RIF. ORIG O.E. NUMBER	NOTE REMARKS	MODELLO / DESCRIZIONE MODEL / DESCRIPTION
0501112 	9790002680 9790002680		BARRA STERZO - TIE ROD
0280513 	9750079980 9750079980	M=16x1,5 RHT	TESTA STERZO - TIE ROD END
0600514 	9750390080 9750390080	M=16x1,5 RHT	SNODO ASSIALE - AXIAL JOINT
1211063 	9750000380 9750000380		CUFFIA STERZO - SINGLE STEERING BOOT
1211064 	9750000280 9750000280		CUFFIA STERZO - SINGLE STEERING BOOT
0901169 	- -		KIT CUFFIE STERZO - KIT STEERING BOOTS
0400097 	4388159 4388159		SNODO SOSPENSIONE INFERIORE - SUSPENSION JOINT LOWER - > 10/1985
0380405 	4391813 4391813		BRACCIO OSCILLANTE - TRACK CONTROL ARM - > 09/1985
0390405 	4391814 4391814		BRACCIO OSCILLANTE - TRACK CONTROL ARM - > 09/1985
0400096 	7567284 7567284		SNODO SOSPENSIONE INFERIORE - SUSPENSION JOINT LOWER - 10/1985 >
0380406 	7695190 7695190		BRACCIO OSCILLANTE - TRACK CONTROL ARM - 10/1985 >









FIAT - DUCATO - TALENTO - > 1994

RIF. OCAP OCAP REF.	RIF. ORIG O.E. NUMBER	NOTE REMARKS	MODELLO / DESCRIZIONE MODEL / DESCRIPTION
0390406 	7695191 7695191		BRACCIO OSCILLANTE - TRACK CONTROL ARM - 10/1985 >
0901527 	- -		KIT SILENTBLOC + TUBETTO - BUSHING KIT
0380565 	7695185 7695185		BRACCIO OSCILLANTE - TRACK CONTROL ARM - MOD.1.8 t - 10/1985 >
0390565 	7695186 7695186		BRACCIO OSCILLANTE - TRACK CONTROL ARM - MOD.1.8 t - 10/1985 >
0901528 	- -		KIT SILENTBLOC + TUBETTO - BUSHING KIT - MOD. 1.8 t
1215388 	4339248 4339248		BOCCOLA BARRA STABILIZZATRICE - RUBBER RING FOR STABILIZING BAR
0281143 	1471655080 1306716080 1471655080 4018A3 4018H4	M=16x1,5 RHT	TESTA STERZO - TIE ROD END - > 12/2002
0282323 	77362278 77362278 4018E0	M=16x1,5 RHT	TESTA STERZO - TIE ROD END - 01/2003 >
0601139 	1471654080 1471654080 400624 4018A4 9945836	M=16x1,5 RHT	SNODO ASSIALE - AXIAL JOINT
0900489 	9946982 9946982 400622 401815		KIT CUFFIA STERZO - STERZO MANUALE - KIT STEERING BOOT - MANUAL STEERING
1211310 	9946982 9946982 4018A5		CUFFIA STERZO - SERVOSTERZO - STEERING BOOT - POWER STEERING









FIAT - DUCATO - 1994 > 2006

RIF. OCAP OCAP REF.	RIF. ORIG O.E. NUMBER	NOTE REMARKS	MODELLO / DESCRIZIONE MODEL / DESCRIPTION
0900449 	9945837 9945837 406635		KIT CUFFIE STERZO - SERVOSTERZO - KIT STEERING BOOTS - POWER STEERING
0401137 	1302368080 1302368080 3640.32 364032		SNODO SOSPENSIONE - BALL JOINT - MOD. 1.0 - 1.4 t. > CH. 6086766
0381141 	1320787080 1308601080 1317241080 1320787080 352165 3521.65		BRACCIO OSCILLANTE - TRACK CONTROL ARM - MOD. 1.0 - 1.4 t. - > CH. 6086766
0391141 	1320786080 1308600080 1317240080 1320786080 352095 3520.95		BRACCIO OSCILLANTE - TRACK CONTROL ARM - MOD. 1.0 - 1.4 t. - > CH. 6086766
0401446 	1331640080 1331640080 364055 3640.55		SNODO SOSPENSIONE - BALL JOINT - MOD. 1.0 - 1.4 t. - CH. 6086766 >
0381446 	1331940080 1339467080 1331940080 3521J3 3521.J3		BRACCIO OSCILLANTE - TRACK CONTROL ARM - MOD. 1.0 - 1.4 t. CH. 6086766 >
0391446 	1331938080 1339465080 1331938080 3520N3 3520.N3		BRACCIO OSCILLANTE - TRACK CONTROL ARM - MOD. 1.0 - 1.4 t. CH. 6086766 >
0401138 	1300473080 1300473080 364033 3640.33		SNODO SOSPENSIONE - BALL JOINT - MOD. 1.8 t - > CH. 6087206









FIAT - DUCATO - 1994 > 2006

RIF. OCAP OCAP REF.	RIF. ORIG O.E. NUMBER	NOTE REMARKS	MODELLO / DESCRIZIONE MODEL / DESCRIPTION
0381140 	1320756080 1308760080 1317239080 1320756080 352166 3521.66		BRACCIO OSCILLANTE - TRACK CONTROL ARM - MOD. 1.8 t - > CH. 6087206
0391140 	1320755080 1320755080 1317238080 1308759080 352096 3520.96		BRACCIO OSCILLANTE - TRACK CONTROL ARM - MOD. 1.8 t - > CH. 6087206
0401451 	1331641080 1331641080 364054 3640.54		SNODO SOSPENSIONE - BALL JOINT - MOD. 1.8 t - CH. 6087206 >
0381451 	1331939080 1339466080 1331939080 3521J4 3521.J4		BRACCIO OSCILLANTE - TRACK CONTROL ARM - MOD. 1.8 t - CH. 6087206 >
0391451 	1331937080 1339464080 1331937080 3520N4 3520.N4		BRACCIO OSCILLANTE - TRACK CONTROL ARM - MOD. 1.8 t - CH. 6087206 >
1215176 	- -		SILENTBLOC CENTRALE - CENTRAL BUSHING
1215177 	- -		SILENTBLOC ESTREMO - OUTER BUSHING
0181602 	1300716080 1300716080		PUNTONE BARRA STABILIZZATRICE - STABILIZER LINK











FIAT - DUCATO - 1994 > 2006

RIF. OCAP OCAP REF.	RIF. ORIG O.E. NUMBER	NOTE REMARKS	MODELLO / DESCRIZIONE MODEL / DESCRIPTION
0181602-K 	- 1300716080 15503811 1300721080 1300720080		KIT PUNTONE BARRA STABILIZZATRICE - STABILIZER LINK KIT
1215491 	1300720080 1300720080		GOMMINO PUNTONE BARRA STABILIZZATRICE - RUBBER RING STABILIZER LINK
0282637 	77364009 381770 77364009	M=16x1,5 RHT	TESTA STERZO - TIE ROD END
0292637 	77364253 381777 77364253	M=16x1,5 RHT	TESTA STERZO - TIE ROD END
0602637 	1345854080 * 4000SF * 4000SG * 1341019080 * 1345854080 *	M=16x1,5 RHT	SNODO ASSIALE - AXIAL JOINT
0902637 	77364254 406686 77364254		KIT CUFFIA STERZO - STEERING BOOT KIT
0402638 	50705629 364067 50705629		SNODO SOSPENSIONE - ASSE ANTERIORE - BALL JOINT - FRONT AXLE - MOD. Q11-Q15-Q17L-Q17Q-Q20
0382638 	1352225080 3521P1 1352225080		BRACCIO OSCILLANTE - ASSE ANTERIORE - INFERIORE - TRACK CONTROL ARM FRONT AXLE - LOWER - MOD. Q11- Q15-Q17L
0392638 	1352227080 3520S0 1352227080		BRACCIO OSCILLANTE - ASSE ANTERIORE - INFERIORE - TRACK CONTROL ARM FRONT AXLE - LOWER - MOD. Q11- Q15-Q17L







FIAT - DUCATO - 2006 >

RIF. OCAP OCAP REF.	RIF. ORIG O.E. NUMBER	NOTE REMARKS	MODELLO / DESCRIZIONE MODEL / DESCRIPTION
0382639 	1352226080 3521P2 1352226080		BRACCIO OSCILLANTE - ASSE ANTERIORE - INFERIORE - TRACK CONTROL ARM FRONT AXLE - LOWER - MOD. Q17H- Q20
0392639 	1352228080 3520S1 1352228080		BRACCIO OSCILLANTE - ASSE ANTERIORE - INFERIORE - TRACK CONTROL ARM FRONT AXLE - LOWER - MOD. Q17H- Q20
1215822 	- -		SILENTBLOC CENTRALE - CENTRAL BUSHING
1215823 	- -		SILENTBLOC ESTREMO - OUTER BUSHING
0182638 	1357572080 Z 1350658080 Z 1357572080 Z 5081N9 Z		STABILIZZATORE - ASSE ANTERIORE - STABILIZER LINK - FRONT AXLE
0503520 	1355449080 Z 1355449080 Z		STABILIZZATORE - ASSE POSTERIORE - STABILIZER LINK - REAR AXLE
0280037 	1306003080 405909 9404059080 1306003080 4322906 3265974	M=14x1,5 RHT	TESTA STERZO - TIE ROD END
0283815 	77362279 77362279	M=14x1,5 RHT	TESTA STERZO - SERVOSTERZO 2004 > - TIE ROD END - POWER STEERING - 2004 >
0600918 	9947713 3812A4 9566950880	M=14x1,5 RHT	SNODO ASSIALE - AXIAL JOINT

FIAT - SCUDO (220) - 1995 > 2006

RIF. OCAP OCAP REF.	RIF. ORIG O.E. NUMBER	NOTE REMARKS	MODELLO / DESCRIZIONE MODEL / DESCRIPTION
0381184 	71737048 71737048 1313084080 1333755080 1322664080 1317390080 1316736080		BRACCIO OSCILLANTE - TRACK CONTROL ARM
0391184 	71737047 71737047 1313083080 1333754080 1322663080 1317389080 1316735080		BRACCIO OSCILLANTE - TRACK CONTROL ARM
1215173 	- -		SILENTBLOCK CENTRALE - CENTRAL BUSHING
1215174 	- -		SILENTBLOCK ESTREMO - DX - OUTER BUSHING - RH
1215175 	- -		SILENTBLOCK ESTREMO - SX - OUTER BUSHING - LH
0181322-K 	1317425080 * 1308664080 * 15503811 * 1311025080 * 1313056080 * 508735 *		KIT PUNTONE BARRA STABILIZZATRICE - STABILIZER LINK KIT
0181322 	1317425080 508735		PUNTONE BARRA STABILIZZATRICE - STABILIZER LINK
0282733 	9403817738 381773 9403817738	M=14x1,5 RHT	TESTA STERZO - TIE ROD END
0602733 	1497552080 3812F0 1497552080 1401381380	M=14x1,5 RHT	SNODO ASSIALE STERZO - AXIAL JOINT
1211477 	9404066838 * 406683 * 9404066838 *		CUFFIA STERZO - STEERING GAITER











FIAT - SCUDO (270) - 2007 >

RIF. OCAP OCAP REF.	RIF. ORIG O.E. NUMBER	NOTE REMARKS	MODELLO / DESCRIZIONE MODEL / DESCRIPTION
0902733 	9404066838 406683 9404066838		KIT CUFFIA STERZO - STEERING GAITER KIT
0382734 	1497407080 3521N9 1497407080		BRACCIO OSCILLANTE - TRACK CONTROL ARM
0392734 	1497408080 3520R8 1497408080		BRACCIO OSCILLANTE - TRACK CONTROL ARM
1215646 	-		SILENTBLOCK ESTREMO - DX - OUTER BUSHING - RH
1215647 	-		SILENTBLOCK ESTREMO - SX - OUTER BUSHING - LH
1215870 	-		SILENTBLOCK CENTRALE - CENTRAL BUSHING
0502735 	1400099680 508756 1400099680		STABILIZZATORE - ASSE ANTERIORE - STABILIZER LINK - FRONT AXLE

FORD - TRANSIT - 1992 > 2000

RIF. OCAP OCAP REF.	RIF. ORIG O.E. NUMBER	NOTE REMARKS	MODELLO / DESCRIZIONE MODEL / DESCRIPTION
0281725 	10391031 10391031 1047145 6517364 6687191	M=16X1,5 RHT	TESTA STERZO - TIE ROD END
0600081 	68699511 68699511	M=16x1,5 RHT	SNODO ASSIALE - AXIAL JOINT
1211073 	61600701 61600701		CUFFIA STERZO - STERZO MANUALE - STEERING BOOT - MANUAL STEERING
1211165 	6869950 6869950		CUFFIA STERZO - SERVOSTERZO - STEERING BOOT- POWER STEERING
0401127 	1055194 1055194		SNODO SOSPENSIONE - INFERIORE - BALL JOINT - LOWER
0401127-K 	- -		KIT SNODO SOSPENSIONE - INFERIORE - BALL JOINT KIT - LOWER
0782751 	6608830 6608830		BRACCIO OSCILLANTE - ASSE ANTERIORE - INFERIORE - TRACK CONTROL ARM - FRONT AXLE - LOWER
0792751 	6608832 6608832		BRACCIO OSCILLANTE - ASSE ANTERIORE - INFERIORE - TRACK CONTROL ARM - FRONT AXLE - LOWER
1215877 	6608818 6608818		SILENTBLOC CENTRALE - CENTRAL BUSHING
1215878 	6517356 6517356		SILENTBLOC CENTRALE - ESTERNO - CENTRAL - OUTER BUSHING











FORD - TRANSIT - 1992 > 2000

RIF. OCAP OCAP REF.	RIF. ORIG O.E. NUMBER	NOTE REMARKS	MODELLO / DESCRIZIONE MODEL / DESCRIPTION
0101724-K 	- 6150970 6150971 1481465 1631619 1549071		KIT PUNTONE BARRA STABILIZZATRICE - STABILIZER LINK KIT
0181724 	6150970 6150970		PUNTONE BARRA STABILIZZATRICE - STABILIZER LINK
0191724 	6150971 6150971		PUNTONE BARRA STABILIZZATRICE - STABILIZER LINK
0283867 	1138275 1138275 4047091	M=16x1,5 RHT	TESTA STERZO - TIE ROD END
0683868 	4059924 4059924	M=16x1,5 RHT	SNODO ASSIALE - AXIAL JOINT
0693868 	4059923 4059923	M=16x1,5 RHT	SNODO ASSIALE - AXIAL JOINT
0983868 	4059922 4059922		KIT CUFFIA STERZO - STEERING BOOT KIT
0993868 	4059921 4059921		KIT CUFFIA STERZO - STEERING BOOT KIT
0403869 	4381927 4381927 4173761 4120734		SNODO SOSPENSIONE - ASSE ANTERIORE - BALL JOINT - FRONT AXLE
0403867 	1417351 1417351 1451917 1763713 1817754 KT6C113K209AA		SNODO SOSPENSIONE - ASSE ANTERIORE - VEICOLI CARICO MAGGIORATO - BALL JOINT - FRONT AXLE - FOR VEHICLES WITH INCREASED AXLE LOAD





FORD - TRANSIT - 2000 > 2013

RIF. OCAP OCAP REF.	RIF. ORIG O.E. NUMBER	NOTE REMARKS	MODELLO / DESCRIZIONE MODEL / DESCRIPTION
0783869 	4540774 4540774 4372130 4164518 4140393 4042022		BRACCIO OSCILLANTE - ASSE ANTERIORE - TRACK CONTROL ARM - FRONT AXLE
0793869 	4540775 4540775 4372131 4164522 4140394 4042023		BRACCIO OSCILLANTE - ASSE ANTERIORE - TRACK CONTROL ARM - FRONT AXLE
0783867 	1553239 1553239 1371231 1438253 1495683 6C113A052BB		BRACCIO OSCILLANTE - ASSE ANTERIORE - VEICOLI CARICOMAGGIORATO - TRACK CONTROL ARM - FRONT AXLE - FOR VEHICLES WITH INCREASED AXLE LOAD
0793867 	1553250 1553250 1371228 1438254 1495684 6C113A053BB		BRACCIO OSCILLANTE - ASSE ANTERIORE - VEICOLI CARICOMAGGIORATO - TRACK CONTROL ARM - FRONT AXLE - FOR VEHICLES WITH INCREASED AXLE LOAD
1215677 	- -		SILENTBLOC CENTRALE - CENTRAL BUSHING
1215678 	4131788 4131788		SILENTBLOC ESTREMO - OUTER BUSHING
0903870 	- 3736028 4041494 3933468		KIT STABILIZZATORE - ASSE ANTERIORE - STABILIZER LINK KIT - FRONT AXLE - SERIE - SERIES: 260/280/300
0503870 	3736028 3736028		STABILIZZATORE - ASSE ANTERIORE - STABILIZER LINK - FRONT AXLE - SERIE - SERIES: 260/208/300
0503254 	4519467 4519467 1495685 1763714		STABILIZZATORE - ASSE ANTERIORE - STABILIZER LINK - FRONT AXLE - SERIE - SERIES: 330/350











FORD - TRANSIT - 2000 > 2013

RIF. OCAP OCAP REF.	RIF. ORIG O.E. NUMBER	NOTE REMARKS	MODELLO / DESCRIZIONE MODEL / DESCRIPTION
0503871 	4042068 4042068		STABILIZZATORE - ASSE POSTERIORE - SOLO MOD. RUOTE GEMELLATE - STABILIZE LINK - REAR AXLE - ONLY MOD. TWIN WHEEL - > 08/2001
0503872 	4440885 4440885		STABILIZZATORE - ASSE POSTERIORE - SOLO MOD. RUOTE GEMELLATE - STABILIZE LINK - REAR AXLE - ONLY MOD. TWIN WHEEL - 08/2001 >
0283867 	1138275 1138275 4047091	M=16x1,5 RHT	TESTA STERZO - TIE ROD END
0603867 	1763991 1763991		SNODO ASSIALE STERZO - AXIAL JOINT
0403869 	4381927 4381927 4173761 4120734		SNODO SOSPENSIONE - ASSE ANTERIORE - BALL JOINT - FRONT AXLE
0783868 	1877332 1877332		BRACCIO OSCILLANTE - ASSE ANTERIORE - TRACK CONTROL ARM - FRONT AXLE
0793868 	1877334 1877334		BRACCIO OSCILLANTE - ASSE ANTERIORE - TRACK CONTROL ARM - FRONT AXLE
1216245 	BK213A262AC BK213A262AC		SILENTBLOCK CENTRALE - CENTRAL BUSHING
1216246 	BK213059A BK213059A		SILENTBLOCK ESTREMO - OUTER BUSHING
0403867 	1417351 1417351 1451917 1763713 1817754 KT6C113K209AA		SNODO SOSPENSIONE - ASSE ANTERIORE - VEICOLI CARICO MAGGIORATO - BALL JOINT - FRONT AXLE - FOR VEHICLES WITH INCREASED AXLE LOAD









FORD - TRANSIT - 08/2013 >

RIF. OCAP OCAP REF.	RIF. ORIG O.E. NUMBER	NOTE REMARKS	MODELLO / DESCRIZIONE MODEL / DESCRIPTION
0783870 	1903526 1903526		BRACCIO OSCILLANTE - ASSE ANTERIORE - VEICOLI CARICO MAGGIORATO - TRACK CONTROL ARM - FRONT AXLE - FOR VEHICLES WITH INCREASED AXLE LOAD
0793870 	1903527 1903527		BRACCIO OSCILLANTE - ASSE ANTERIORE - VEICOLI CARICO MAGGIORATO - TRACK CONTROL ARM - FRONT AXLE - FOR VEHICLES WITH INCREASED AXLE LOAD
1216245 	BK213A262AC BK213A262AC		SILENTBLOCK CENTRALE - CENTRAL BUSHING
1216246 	BK213059A BK213059A		SILENTBLOCK ESTREMO - OUTER BUSHING
0503254 	4519467 4519467 1495685 1763714		STABILIZZATORE - ASSE ANTERIORE - STABILIZER LINK - FRONT AXLE











IVECO - DAILY 30.8 > 59.12

RIF. OCAP OCAP REF.	RIF. ORIG O.E. NUMBER	NOTE REMARKS	MODELLO / DESCRIZIONE MODEL / DESCRIPTION
0280515 	1903652 1903652	L=80 M=16x1,5 RHT	TESTA STERZO - TIE ROD END
0287552 	42534911 42534911	L=80 M=16x1,5 RHT	TESTA STERZO - TIE ROD END - MOD: 35S9/10/11/12/13/15/ 35C9/10/11/12/13/15/65C11/13/15-29L10/12
0600516 	9983325 9983325	L=310 M=16x1,5 RHT	SNODO ASSIALE - AXIAL JOINT
0606927 	- -	M=16x1,5 RHT	SNODO ASSIALE - AXIAL JOINT
0280517 	93802209 93802209	L=72 M=20x1,5 RHT	TESTA BARRA SOSPENSIONE - ASSE ANTERIORE - SUSPENSION JOINT - FRONT AXLE
0286616 	500337201 500337201	L=80 M=20x1,5 RHT	TESTA BARRA SOSPENSIONE - ASSE ANTERIORE - SUSPENSION JOINT - FRONT AXLE - MOD: RESTYLING - NEW DAILY - TURBODAILY - DAILY CNG
0400518 	93802242 93802242	M=20x1,5 RHT	SNODO SOSPENSIONE ASSE ANTERIORE - ECCETTO - BALL JOINT FRONT AXLE - EXCEPT - MOD: 35S9/10/11/12/13/15 - 35C9/10/11/12/13/15 - 29L10/12
0787249  A B	500379802 500379802 42551297		BRACCIO OSCILLANTE ASSE ANTERIORE SUPERIORE - UPPER TRACK CONTROL ARM FRONT AXLE - MOD: 35S9 /10/ 11/12/13/15 - 35C9 /10/11/12/13/15 - 29L10 /12
0797249  B A	500379801 500379801 42551296		BRACCIO OSCILLANTE ASSE ANTERIORE SUPERIORE - UPPER TRACK CONTROL ARM FRONT AXLE - MOD: 35S9 /10/ 11/12/13/15 - 35C9 /10/11/12/13/15 - 29L10 /12
0407249  A	- -		SNODO SOSPENSIONE - BALL JOINT - MOD: 35S9/10/11/12/13/ 15 - 35C9/10/11/12/13/15 - 29L10/12







IVECO - DAILY 30.8 > 59.12

RIF. OCAP OCAP REF.	RIF. ORIG O.E. NUMBER	NOTE REMARKS	MODELLO / DESCRIZIONE MODEL / DESCRIPTION
1215953 B 	504039506 504039506		SILENTBLOC BRACCI OSCILLANTI - CONTROL ARMS BUSHING - MOD: 35S9 /10/11/12/13/15 - 35C9/10/11/12/13/15 - 29L10 /12
0787250 A  B	500334716 500334716 42551290		BRACCIO OSCILLANTE ASSE ANTERIORE INFERIORE - LOWER TRACK CONTROL ARM FRONT AXLE - MOD. 35S9 /10/ 11/12/13/15 - 35C9 /10/11/12/13/15 - 29L10 /12
0797250 B  A	500334717 500334717 42551289		BRACCIO OSCILLANTE ASSE ANTERIORE SUPERIORE - UPPER TRACK CONTROL ARM FRONT AXLE - MOD. 35S9 /10/ 11/12/13/15 - 35C9 /10/11/12/13/15 - 29L10 /12
0407250 A 	- -		SNODO SOSPENSIONE BRACCIO OSCILLANTE - ANTERIORE INFERIORE - TRACK CONTROL ARM BALLJOINT - FRONT LOWER - MOD: 35S9 /10/11/12/13/15 - 35C9 /10/11/12/13/15 - 29L10 /12
1215953 B 	504039506 504039506		SILENTBLOC BRACCI OSCILLANTI - CONTROL ARMS BUSHING - MOD: 35S9 /10/11/12/13/15 - 35C9/10/11/12/13/15 - 29L10 /12
0903144 	- 504039506 16750635 500339201 500317413		KIT RIPARAZIONE BRACCI OSCILLANTI IN LAMIERA - TRACK CONTROL ARM SHEET METAL REPAIRING KIT - MOD. : 35S9 / 10/11/12/13/15 - 35C9 /10/11/12/13/15 - 29L10 /12
1215269 	93807641 93807641		SILENTBLOC BRACCIO OSCILLANTE SUPERIORE - ASSE ANTERIORE - UPPER CONTROL ARM BUSHING - FRONT AXLE - MOD. RESTYLING: 49-10 - NEW DAILY: 30-8 > 35-12 - TURBODAILY: 30-10 > 35-12 - DIAM. 32 mm.
1215271 	93810239 93810239		SILENTBLOC BRACCIO OSCILLANTE SUPERIORE - ASSE ANTERIORE - UPPER CONTROL ARM BUSHING - FRONT AXLE - MOD. RESTYLING: 49-10 - NEW DAILY: 30-8 > 35-12 - TURBODAILY: 30-10 > 35-12 - DIAM. 37 mm.
1215270 	93807640 93807640		SILENTBLOC BRACCIO OSCILLANTE INFERIORE - ASSE ANTERIORE - LOWER CONTROL ARM BUSHING - FRONT AXLE - MOD. RESTYLING: 49-10 - NEW DAILY: 30-8 > 35-12 - TURBODAILY: 30-10 > 35-12 - DIAM. 29 mm.











IVECO - DAILY 30.8 > 59.12

RIF. OCAP OCAP REF.	RIF. ORIG O.E. NUMBER	NOTE REMARKS	MODELLO / DESCRIZIONE MODEL / DESCRIPTION
0587871 	500383975 500383975		STABILIZZATORE ASSE ANTERIORE - STABILIZER LINK - FRONT AXLE - MOD: 35S9/10/11/12/13/15 - 29L10
0597871 	500383976 500383976		STABILIZZATORE ASSE ANTERIORE - STABILIZER LINK - FRONT AXLE - MOD: 35S9/10/11/12/13/15 - 29L10
0287552 	42534911 42534911	L=80 M=16x1,5 RHT	TESTA STERZO - TIE ROD END
0602749 	2992593 2992593	M=16x1,5 RHT	SNODO ASSIALE - AXIAL JOINT
0607552 	42532977 42532977 99463268	L=348 M=16x1,5 RHT	SNODO ASSIALE - AXIAL JOINT
0902749 	2992592 2992592		KIT CUFFIA STERZO - STEERING BOOT KIT
1211482 	- -		CUFFIA STERZO - STEERING BOOT
0280517 	93802209 93802209	L=72 M=20x1,5 RHT	TESTA BARRA SOSPENSIONE - ASSE ANTERIORE - SUSPENSION JOINT - FRONT AXLE
0407893 	504212586 504212586	M=18x1,5 RHT	SNODO SOSPENSIONE ASSE ANTERIORE - BALL JOINT FRONT AXLE
0407894 	5801378064 5801378064		SNODO SOSPENSIONE ASSE ANTERIORE - BALL JOINT FRONT AXLE - MOD. 90 Q.II









LDV - MAXSUS - 2005 >

RIF. OCAP OCAP REF.	RIF. ORIG O.E. NUMBER	NOTE REMARKS	MODELLO / DESCRIZIONE MODEL / DESCRIPTION
0405069 	542410025 542410025 542410018		SNODO SOSPENSIONE - ASSE ANTERIORE - INFERIORE - BALL JOINT - FRONT AXLE - LOWER
0385072 	542150012 542150012		BRACCIO OSCILLANTE - ASSE ANTERIORE - INFERIORE - TRACK CONTROL ARM - FRONT AXLE - LOWER
0395072 	542150011 542150011		BRACCIO OSCILLANTE - ASSE ANTERIORE - INFERIORE - TRACK CONTROL ARM - FRONT AXLE - LOWER
0585068 	542180024 542180024		STABILIZZATORE - ASSE ANTERIORE - STABILIZER LINK - FRONT AXLE
0595068 	542180023 542180023		STABILIZZATORE - ASSE ANTERIORE - STABILIZER LINK - FRONT AXLE
0858054 	542180020 542180020		BARRA STABILIZZATRICE - ASSE ANTERIORE - STABILIZING BAR - FRONT AXLE











MERCEDES - MB100 > MB180 - 1988 >

RIF. OCAP OCAP REF.	RIF. ORIG O.E. NUMBER	NOTE REMARKS	MODELLO / DESCRIZIONE MODEL / DESCRIPTION
0502258  0182261 M=18x1,5 RHT 0192258 M=18x1,5 LHT	6313300303 6313300303	L=260	BARRA STERZO - TIE ROD
0182261 	6313380310 6313380310 0004606548	L=95 M=18x1,5 RHT	TESTA STERZO - TIE ROD END
0192258 	6313380410 6313380410	L=95 M=18x1,5 LHT	TESTA STERZO - TIE ROD END
0502259  0182259 M=24x1,5 RHT	6313300603 6313300603	L=653	BARRA STERZO - TIE ROD
0182259 	6313300535 6313300535	L=105 M=24x1,5 RHT	TESTA STERZO - TIE ROD END
0502260  0182260 M=20x1,5 RHT 0192260 M=20x1,5 LHT	6313300703 6313300703 6313300503	L=265	BARRA STERZO - TIE ROD
0182260 	4603301235 0004607248 0013304835 4603301235	L=95 M=20x1,5 RHT	TESTA STERZO - TIE ROD END
0192260 	6313300435 6313300435	L=100 M=20x1,5 LHT	TESTA STERZO - TIE ROD END
0502261  0182261 M=18x1,5 RHT	6314600705 6314600705	L=1223	BARRA STERZO - TIE ROD
0182261 	0004606548 6313380310 0004606548	L=95 M=18x1,5 RHT	TESTA STERZO - TIE ROD END











MERCEDES - MB100 > MB180 - 1988 >

RIF. OCAP OCAP REF.	RIF. ORIG O.E. NUMBER	NOTE REMARKS	MODELLO / DESCRIZIONE MODEL / DESCRIPTION
0402159 	6313200228 0003200028 0003200128 6083200028 6083200128 6313200028 6313200228	M=16x1,5 RHT	SNODO SOSPENSIONE - BALL JOINT
0501503  0281503 M=16x1,5 RHT	9014600205 9014600205 2D0422803		BARRA STERZO - SCATOLA GUIDA - TIE ROD - STEERING BOX
0281503 	9014600348 9014600348 9014600048 9014600148 2D0422811	L=76 M=16x1,5 RHT	TESTA STERZO - SCATOLA GUIDA - TIE ROD END - STEERING BOX
0601504 	- 9014600155 9014600255 9014600455 2D0422803	M=16x1,5 RHT	SNODO ASSIALE - SCATOLA GUIDA - AXIAL JOINT - STEERING BOX
1211400 	- 2D0422831		CUFFIA STERZO - STEERING BOOT
0901504 	9014605500 9014605500 2D0498831		KIT CUFFIA STERZO - STEERING BOOT KIT
0401505 	9013331127 9013331227 9013331127 9013331027 9013330727 9013330627 2D0407361A	M=20x1,5	SNODO SOSPENSIONE ASSE ANTERIORE - BALL JOINT FRONT AXLE
0781505 	9013302507 9013302507 9013301907 2D0407022B 2D0407022		BRACCIO OSCILLANTE - ANTERIORE - TRACK CONTROL ARM - FRONT
0791505 	9013301807 9013301807 2D0407021B 2D0407021		BRACCIO OSCILLANTE - ANTERIORE - TRACK CONTROL ARM - FRONT









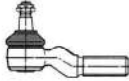
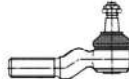

MERCEDES - SPRINTER - 1995 > 05/2006

RIF. OCAP OCAP REF.	RIF. ORIG O.E. NUMBER	NOTE REMARKS	MODELLO / DESCRIZIONE MODEL / DESCRIPTION
1215705 	9013330214 9013330214 2D0407140		SILENTBLOC - BUSHING
0581514 	9013200389 9013200389 2D0411052		STABILIZZATORE - ASSE ANTERIORE - CON SILENTBLOC - STABILIZER LINK- FRONT AXLE WITH BUSHING
0591514 	9013200289 9013200289 2D0411051		STABILIZZATORE - ASSE ANTERIORE - CON SILENTBLOC - STABILIZER LINK- FRONT AXLE WITH BUSHING
0502368 	9013200689 9013200689	L=300	STABILIZZATORE - ASSE POSTERIORE - STABILIZER LINK - REAR AXLE
0502379 	9013200589 9013200589	L=230	STABILIZZATORE - ASSE POSTERIORE - STABILIZER LINK - REAR AXLE
0104151 	9013200089 2D0511329 9013200089	L=95	STABILIZZATORE - ASSE POSTERIORE - STABILIZER LINK - REAR AXLE
0282717 	9064600048 9064600048	M=16x1,5 RHT	TESTA STERZO - TIE ROD END
0602741-K 	9064600055 9064600055		KIT SNODO ASSIALE - AXIAL JOINT KIT
0602741 	- -	M=16x1,5 RHT	SNODO ASSIALE - AXIAL JOINT
0902741 	9064600096 9064600096		KIT CUFFIA STERZO - STEERING BOOT KIT
1211481 	- -		CUFFIA STERZO - STEERING BOOT KIT

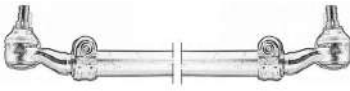



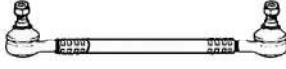





MERCEDES - SPRINTER - 06/2006 >

RIF. OCAP OCAP REF.	RIF. ORIG O.E. NUMBER	NOTE REMARKS	MODELLO / DESCRIZIONE MODEL / DESCRIPTION
0402742 	- -		SNODO SOSPENSIONE - ASSE ANTERIORE - BALL JOINT - FRONT AXLE
0782742 	9063304107 2E0407152M		BRACCIO OSCILLANTE - ASSE ANTERIORE - TRACK CONTROL ARM - FRONT AXLE
0792742 	9063304007 9063304007		BRACCIO OSCILLANTE - ASSE ANTERIORE - TRACK CONTROL ARM - FRONT AXLE
1215874 	9063330014 9063330014		SILENTBLOC - BUSHING
0582743 	9063201889 9063201889		STABILIZZATORE - ASSE ANTERIORE - STABILIZER LINK - FRONT AXLE
0592743 	9063201789 9063201789		STABILIZZATORE - ASSE ANTERIORE - STABILIZER LINK - FRONT AXLE
0502744 	6013201389 6013201389		STABILIZZATORE - ASSE POSTERIORE - STABILIZER LINK - REAR AXLE
1215817 	6013210350 6013210350		SILENTBLOC STABILIZZATORE - ASSE POSTERIORE - STABILIZER LINK BUSHING - REAR AXLE
0502252   0182252 M=16x1,5 RHT  0192252 M=16x1,5 LHT	6083300303 6083300303	L=510	BARRA STERZO - TIE ROD - MOD.: T1 207D

MERCEDES - T1 (601-602) - >1996

RIF. OCAP OCAP REF.	RIF. ORIG O.E. NUMBER	NOTE REMARKS	MODELLO / DESCRIZIONE MODEL / DESCRIPTION
0182252 	6083330027 6083330027	L=90 M=16x1,5 RHT	TESTA STERZO - TIE ROD END - MOD.: T1 207D
0192252 	6083380110 6083380110	L=90 M=16x1,5 LHT	TESTA STERZO - TIE ROD END - MOD.: T1 207D
0502253  0180727  M=20x1,5 RHT	6023300403 6023300403 6023300003 6023300103 6023300303	L=1335	BARRA STERZO - TIE ROD
0180727 	6013300435 6013300435 6013300635 6013305335	L=95 M=20x1,5 RHT	TESTA STERZO - TIE ROD END
0190727 	6013305235 6013300535 6013300735 6013305235	L=95 M=20x1,5 LHT	TESTA STERZO - TIE ROD END
0502254  0182254  M=24x1,5 RHT 0192254  M=24x1,5 LHT	6023305403 6023300903 6023301003 6023305303 6023305403	L=1345	BARRA STERZO - TIE ROD - MOD.: T1
0182254 	6023305835 6023300035 6023305535 6023305835	L=115 M=24x1,5 RHT	TESTA STERZO - TIE ROD END - MOD.: T1
0192254 	6023305735 6023300135 6023305435 6023305735 6083305535 6083305735	L=115 M=24x1,5 LHT	TESTA STERZO - TIE ROD END - MOD.: T1
0502255 	6083300403 6083300403 5829067053	L=312	BARRA STERZO - TIE ROD - MOD.: T1 (601)
0502256 	6084600105 6084600105	L=1135	BARRA STERZO - TIE ROD - MOD.: T1 (601)







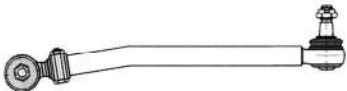

MERCEDES - T1 (601-602) - >1996

RIF. OCAP OCAP REF.	RIF. ORIG O.E. NUMBER	NOTE REMARKS	MODELLO / DESCRIZIONE MODEL / DESCRIPTION
0500730  0180730 	6014600305 3094600305 3094602905 3094603005 3094603105 3094603205 6014600005 6014600105 6014600205 6014600305	L=470	BARRA STERZO - TIE ROD - MOD.: T1
0502257  0180730 M=22x1,5 RHT 0190731 M=22x1,5 LHT 	6014601505 6014600505 6014600605 6014600705 6014600805 6014600905 6014601005 6014601105 6014601205 6014601305 6014601505	L=450	BARRA STERZO - TIE ROD
0180730 	3103301335 0004604148 0004608548 3103301335	L=95 M=22x1,5 RHT	TESTA STERZO - TIE ROD END
0190731 	0004608748 0004608748 0004608648 0004604648 0004604248	L=250 M=22x1,5 LHT	TESTA STERZO - TIE ROD END
0402159 	6313200228 0003200028 0003200128 6083200028 6083200128 6313200028 6313200228	M=16x1,5 RHT	SNODO SOSPENSIONE - BALL JOINT - MOD.: T1 (601) 207D
0501347 	6014300535 6014300535		STABILIZZATORE - STABILIZER LINK - MOD. T1
0507659  0186613 	6704602605 6704602605 6704602705	L=495 T=32	BARRA STERZO - TIE ROD - MOD.: 809-811-814
0186613 	0003309335 0003309335 0003301435 0003301535 0003307135 0003309535 0003382129	L=105 M=28x1,5 RHT	TESTA STERZO - TIE ROD END - MOD.: 809-811-814











MERCEDES - T2/LN1 (507 > 814) - 1986 >

RIF. OCAP OCAP REF.	RIF. ORIG O.E. NUMBER	NOTE REMARKS	MODELLO / DESCRIZIONE MODEL / DESCRIPTION
0507960  0187560  M=24x1,5 RHT	6684602105 6684602105 6684602205	L=495 T=28	BARRA STERZO - TIE ROD - MOD.: 507-508-510-609-611-709-711-714
0187560 	0013301435 0013301435 0003301035 0003381610 0013301235 0003301135 0003301635	L=95 M=24x1,5 RHT	TESTA STERZO - TIE ROD END - MOD.: 507-508-510-609-611-709-711-714
0507624  0186613  M=28x1,5 RHT	6704602905 6704602805 6704602905	L=495 T=32	BARRA STERZO - TIE ROD - MOD.: 709-711-714-809-811-814
0186613 	0003309335 0003309335 0003301435 0003301535 0003307135 0003309535 0003382129	L=105 M=28x1,5 RHT	TESTA STERZO - TIE ROD END - MOD.: 709-711-714-809-811-814
0507826  0187560  M=24x1,5 RHT	6684602405 6684602305 6684602405	L=495 T=28	BARRA STERZO - TIE ROD - MOD.: 507-508-510-609-611-709-711-714
0187560 	0013301435 0013301435 0003301035 0003381610 0013301235 0003301135 0003301635	L=95 M=24x1,5 RHT	TESTA STERZO - TIE ROD END - MOD.: 507-508-510-609-611-709-711-714
0507830  0186613  M=28x1,5 RHT	6704601605 6704600805 6704601205 6704601605 6704602005	L=505 T=32	BARRA STERZO - TIE ROD - MOD.: 809-811-814
0186613 	0003309335 0003309335 0003301435 0003301535 0003307135 0003309535 0003382129	L=105 M=28x1,5 RHT	TESTA STERZO - TIE ROD END - MOD.: 809-811-814





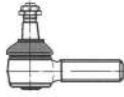



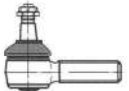

MERCEDES - T2/LN1 (507 > 814) - 1986 >

RIF. OCAP OCAP REF.	RIF. ORIG O.E. NUMBER	NOTE REMARKS	MODELLO / DESCRIZIONE MODEL / DESCRIPTION
0507660  0187560 M=24x1,5 RHT	6684601105 6684600905 6684600505 6684600705 6684601105	L=505 T=28	BARRA STERZO - TIE ROD - MOD.: 507-508-510-609-611-709
0187560 	0013301435 0013301435 0003301035 0003381610 0013301235 0003301135 0003301635	L=95 M=24x1,5 RHT	TESTA STERZO - TIE ROD END - MOD.: 507-508-510-609-611-709
0507656  0187560 M=24x1,5 RHT	6684601705 6684601905 6684601705 6684601505	L=505 T=28	BARRA STERZO - TIE ROD - MOD.: 609-611-668-669-709-711-714
0187560 	0013301435 0013301435 0003301035 0003381610 0013301235 0003301135 0003301635	L=95 M=24x1,5 RHT	TESTA STERZO - TIE ROD END - MOD.: 609-611-668-669-709-711-714
0507898  0186613 M=28x1,5 RHT	6704602205 6704600905 6704601805 6704602205	L=505 T=32	BARRA STERZO - TIE ROD - MOD.: 507-508-510-709-711-714-809-811-814
0186613 	0003309335 0003309335 0003301435 0003301535 0003307135 0003309535 0003382129	L=105 M=28x1,5 RHT	TESTA STERZO - TIE ROD END - MOD.: 507-508-510-709-711-714-809-811-814
0507831  0180730 M=22x1,5 RHT	6674601005 6674600705 6674601005	L=505 T=26	BARRA STERZO - TIE ROD - MOD.: 507-508-510
0501499  0180727 M=20x1,5 RHT 0190727 M=20x1,5 LHT	6673300603 6673300603 6673300503 6673300303 6673300403	L=1.600	BARRA STERZO - TIE ROD - MOD.: 507-508-510





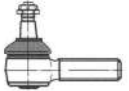

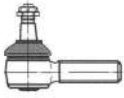

MERCEDES - T2/LN1 (507 > 814) - 1986 >

RIF. OCAP OCAP REF.	RIF. ORIG O.E. NUMBER	NOTE REMARKS	MODELLO / DESCRIZIONE MODEL / DESCRIPTION
0180727 	6013305335 6013300435 6013300635 6013305335	L=95 M=20x1,5 RHT	TESTA STERZO - TIE ROD END - MOD.: 507-508-510
0190727 	6013305235 6013300535 6013300735 6013305235	L=95 M=20x1,5 LHT	TESTA STERZO - TIE ROD END - MOD.: 507-508-510
0507653   0186612 M=24x1,5 RHT  0196612 M=24x1,5 LHT	6703300303 6693300403 6693300503 6703300003 6703300103 6703300203 6703300303 6883300003 6883300103	L=1594 T=35	BARRA STERZO - TIE ROD - MOD.: 507-508-510 - 609D-611D-709D-711D-714D-809D - 811D-814D
0186612 	0003309735 0003301235 0003307535 0003309735 0003309935 0003383429 0003383529 0023301335	L=106 M=24x1,5 RHT	TESTA STERZO - TIE ROD END - MOD.: 507-508-510 - 609D-611D-709D-711D-714D-809D - 811D-814D
0196612 	0003309835 0003301335 0003309835 0013300035 0083380029	L=106 M=24x1,5 LHT	TESTA STERZO - TIE ROD END - MOD.: 507-508-510 - 609D-611D-709D-711D-714D-809D - 811D-814D
0507960   0187560 M=24x1,5 RHT	6684602105 6684602105 6684602205	L=495 T=28	BARRA STERZO - TIE ROD - MOD.: 512 D
0187560 	0013301435 0013301435 0003301035 0003381610 0013301235 0003301135 0003301635	L=95 M=24x1,5 RHT	TESTA STERZO - TIE ROD END - MOD.: 512 D
0507826   0187560 M=24x1,5 RHT	6684602405 6684602305 6684602405	L=495 T=28	BARRA STERZO - TIE ROD - MOD.: 512 D













MERCEDES - VARIO - 1996 >

RIF. OCAP OCAP REF.	RIF. ORIG O.E. NUMBER	NOTE REMARKS	MODELLO / DESCRIZIONE MODEL / DESCRIPTION
0187560 	0013301435 0013301435 0003301035 0003381610 0013301235 0003301135 0003301635	L=95 M=24x1,5 RHT	TESTA STERZO - TIE ROD END - MOD.: 512 D
0507608  0186613  M=28x1,5 RHT	6674601805 6674601605 6674601805	L=504 T=34	BARRA STERZO - TIE ROD - MOD.: 512-612-613-615 - 810-812-813-814-815
0186613 	0003309335 0003309335 0003301435 0003301535 0003307135 0003309535 0003382129	L=105 M=28x1,5 RHT	TESTA STERZO - TIE ROD END - MOD.: 809-811-814
0507905  0186613  M=28x1,5 RHT	6674601505 6674601505 6674601705	L=504 T=34	BARRA STERZO - TIE ROD - MOD.: 512-612-613-615-616 - 810-812-813-815
0186613 	0003309335 0003309335 0003301435 0003301535 0003307135 0003309535 0003382129	L=105 M=28x1,5 RHT	TESTA STERZO - TIE ROD END
0507656  0187560  M=24x1,5 RHT	6684601705 6684601905 6684601705 6684601505	L=505 T=28	BARRA STERZO - TIE ROD - MOD.: 512 D
0187560 	0013301435 0013301435 0003301035 0003381610 0013301235 0003301135 0003301635	L=95 M=24x1,5 RHT	TESTA STERZO - TIE ROD END - MOD.: 512 D
0507660  0187560  M=24x1,5 RHT	6684601105 6684600905 6684600505 6684600705 6684601105	L=505 T=28	BARRA STERZO - TIE ROD - MOD.: 512 D





MERCEDES - VARIO - 1996 >

RIF. OCAP OCAP REF.	RIF. ORIG O.E. NUMBER	NOTE REMARKS	MODELLO / DESCRIZIONE MODEL / DESCRIPTION
0187560 	0013301435 0013301435 0003301035 0003381610 0013301235 0003301135 0003301635	L=95 M=24x1,5 RHT	TESTA STERZO - TIE ROD END - MOD.: 512 D
0501904  0281904 M=16x1,5 RHT	6384600205 6384600205		BARRA STERZO - TIE ROD
0281904 	6384600048 6384600048	L=75 M=16x1,5 RHT	TESTA STERZO - TIE ROD END
0601905 	6384600255 6384600255	L=359 M=16x1,5 RHT	SNODO ASSIALE - AXIAL JOINT
1211400 	- 2D0422831		CUFFIA STERZO - STEERING BOOT
0901504 	9014605500 9014605500 2D0498831		KIT CUFFIA STERZO - STEERING BOOT KIT
0401906 	6383330027 6383330027		SNODO SOSPENSIONE - SUSPENSION JOIN
0781906 	6383300110 6383300110		BRACCIO OSCILLANTE - TRACK CONTROL ARM
0791906 	6383300010 6383300010		BRACCIO OSCILLANTE - TRACK CONTROL ARM









MERCEDES - VITO - 1996 > 2003

RIF. OCAP OCAP REF.	RIF. ORIG O.E. NUMBER	NOTE REMARKS	MODELLO / DESCRIZIONE MODEL / DESCRIPTION
1215503 	- -		SILENTBLOCK CENTRALE - CENTRAL BUSHING
1215504 	- -		SILENTBLOCK ESTREMO - OUTER BUSHING
0581907 	6383230368 6383230368		STABILIZZATORE - STABILIZER LINK
0591907 	6383230268 6383230268		STABILIZZATORE - STABILIZER LINK
0584163 	6383230568 6383230568		STABILIZZATORE - ASSE ANTERIORE - STABILIZER LINK - FRONT AXLE - CH. 267541 >
0594163 	6383230468 6383230468		STABILIZZATORE - ASSE ANTERIORE - STABILIZER LINK - FRONT AXLE - CH. 267541 >
0504160 	6383260116 6383260116		STABILIZZATORE - ASSE POSTERIORE - STABILIZER LINK - REAR AXLE
0284249 	6394600548 6384600048 6394600348 6394600548		TESTA STERZO - TIE ROD END - RHT M16x1,5
0294249 	6394600048 6394600048		TESTA STERZO - TIE ROD END - RHT M16x1,5
0604250-K 	6394600055 6394600055		KIT SNODO ASSIALE - AXIAL JOINT KIT - RHT M16x1,5
0604250 	- -		SNODO ASSIALE - AXIAL JOINT - RHT M16x1,5
0404260 	- -		SNODO SOSPENSIONE - ASSE ANTERIORE - INFERIORE - CON KIT - BALL JOINT - FRONT AXLE - LOWER - WITH KIT



MERCEDES - VITO - 2003 >

RIF. OCAP OCAP REF.	RIF. ORIG O.E. NUMBER	NOTE REMARKS	MODELLO / DESCRIZIONE MODEL / DESCRIPTION
0784260 	6393300510 6393300510		BRACCIO OSCILLANTE - ASSE ANTERIORE - INFERIORE - TRACK CONTROL ARM - FRONT AXLE - LOWER
0794260 	6393300410 6393300410		BRACCIO OSCILLANTE - ASSE ANTERIORE - INFERIORE - TRACK CONTROL ARM - FRONT AXLE - LOWER
1215704 	6393330214 6393330214		SILENTBLOC - BUSHING
0584262 	6393200189 6393200189		STABILIZZATORE - ASSE ANTERIORE - STABILIZER LINK - FRONT AXLE
0594262 	6393200089 6393200089		STABILIZZATORE - ASSE ANTERIORE - STABILIZER LINK - FRONT AXLE









NISSAN - INTERSTAR - 2002 >

RIF. OCAP OCAP REF.	RIF. ORIG O.E. NUMBER	NOTE REMARKS	MODELLO / DESCRIZIONE MODEL / DESCRIPTION
0281495 	48520-00QAJ 7701470364 48520-00QAJ 4501263 9161563	L=222 M=16x1,5 RHT	TESTA STERZO - TIE ROD END
0291495 	48520-00QAH 7701470363 48520-00QAH 4501262 9161562	L=222 M=16x1,5 RHT	TESTA STERZO - TIE ROD END
0603811 	48521-00QAF - 48521-00QAF	M=16x1,5 RHT	SNODO ASSIALE STERZO - AXIAL JOINT
0401494 	40160-00QAD 7700312852 40160-00QAD 4500255 9160555		SNODO SOSPENSIONE - INFERIORE - BALL JOINT - LOWER
0381494 	54500-00QAC 7700309190 54500-00QAC 4404048 54500-00QAD 4500093 54500-00QAE 9160393 4418213		BRACCIO OSCILLANTE - ASSE ANTERIORE - INFERIORE - TRACK CONTROL ARM - FRONT AXLE - LOWER
0391494 	54501-00QAC 7700309189 54501-00QAC 4500092 54501-00QAD 9160392 54501-00QAE 4418212		BRACCIO OSCILLANTE - ASSE ANTERIORE - INFERIORE - TRACK CONTROL ARM - FRONT AXLE - LOWER
0401522 	40160-00QAB 7700312851 40160-00QAB	M=14x1,5 RHT	SNODO SOSPENSIONE BRACCIO SUPERIORE - LATO ESTERNO - BALL JOINT UPPER CONTROL ARM - OUTER SIDE
1215609 	54570-00QAA 7700302122 54570-00QAA 4500094 9160394		SILENTBLOC CENTRALE - CENTRAL BUSHING
1215610 	54423-00QAA 7700302123 54423-00QAA 4500095 9160395		SILENTBLOC ESTREMO - OUTER BUSHING











NISSAN - INTERSTAR - 2002 >

RIF. OCAP OCAP REF.	RIF. ORIG O.E. NUMBER	NOTE REMARKS	MODELLO / DESCRIZIONE MODEL / DESCRIPTION
0583812 	54618-00QAA 54618-00QAA 7700309071 7700307343 4500199 9160499		STABILIZZATORE - ASSE ANTERIOREE - STABILIZER LINK - FRONT AXLE
0593812 	54618-00QAB 54618-00QAB 7700309070 7700302165 4500198 9160498		STABILIZZATORE - ASSE ANTERIOREE - STABILIZER LINK - FRONT AXLE











OPEL - MOVANO - 1999 >

RIF. OCAP OCAP REF.	RIF. ORIG O.E. NUMBER	NOTE REMARKS	MODELLO / DESCRIZIONE MODEL / DESCRIPTION
0281495 	4501263 7701470364 48520-00QAJ 4501263 9161563	L=222 M=16x1,5 RHT	TESTA STERZO - TIE ROD END
0291495 	4501262 7701470363 48520-00QAH 4501262 9161562	L=222 M=16x1,5 RHT	TESTA STERZO - TIE ROD END
0603811-K 	4501261 4501261 9161561		KIT SNODO ASSIALE - AXIAL JOINT KIT
0603811 	- - 48521-00QAF	M=16x1,5 RHT	SNODO ASSIALE - AXIAL JOINT
0401494 	4500255 7700312852 40160-00QAD 4500255 9160555		SNODO SOSPENSIONE - BALL JOINT
0381494 	4404048 7700309190 54500-00QAC 4404048 54500-00QAD 4500093 54500-00QAE 9160393 4418213		BRACCIO OSCILLANTE - TRACK CONTROL ARM
0391494 	4500092 7700309189 54501-00QAC 4500092 54501-00QAD 9160392 54501-00QAE 4418212		BRACCIO OSCILLANTE - TRACK CONTROL ARM
1215609 	4500094 7700302122 54570-00QAA 4500094 9160394		SILENTBLOC CENTRALE - CENTRAL BUSHING
1215610 	7700302123 7700302123 54423-00QAA 4500095 9160395		SILENTBLOC ESTREMO - OUTER BUSHING









OPEL - MOVANO - 1999 >

RIF. OCAP OCAP REF.	RIF. ORIG O.E. NUMBER	NOTE REMARKS	MODELLO / DESCRIZIONE MODEL / DESCRIPTION
0401522 	7700312851 7700312851 40160-00QAB	M=14x1,5 RHT	SNODO SOSPENSIONE BRACCIO SUPERIORE - LATO ESTERNO - BALL JOINT UPPER CONTROL ARM - OUTER SIDE
0401523 	44019101 4401910 4500090		SNODO SOSPENSIONE BRACCIO SUPERIORE - LATO INTERNO - BALL JOINT UPPER CONTROL ARM - INNER SIDE
0583812 	4500199 54618-00QAA 7700309071 7700307343 4500199 9160499		STABILIZZATORE - ASSE ANTERIORE - STABILIZER LINK - FRONT AXLE
0593812 	4500198 54618-00QAB 7700309070 7700302165 4500198 9160498		STABILIZZATORE - ASSE ANTERIORE - STABILIZER LINK - FRONT AXLE
0281536 	4420098 4420098 93167689 485200780R	M=18x1,5 RHT	TESTA STERZO - TIE ROD END
0291536 	4420097 4420097 93167688 485206730R	M=18x1,5 RHT	TESTA STERZO - TIE ROD END
0901536 	4420096 4420096 93167687 485212373R	M=18x1,5 RHT	KIT SNODO ASSIALE - AXIAL JOINT KIT
0601536 	4420096 Z 4420096 Z 93167687 Z 485212373R	M=18x1,5 RHT	SNODO ASSIALE - AXIAL JOINT
0903811 	4501260 4501260 9161560 6000025546 Z 6025370231 Z		KIT CUFFIA STERZO - STEERING BOOT KIT
1211392 	4501260 Z 4501260 Z 9161560 Z 6001547607 7701470361 6025370231		CUFFIA STERZO - STEERING BOOT

OPEL - MOVANO B - 05/2010 >

RIF. OCAP OCAP REF.	RIF. ORIG O.E. NUMBER	NOTE REMARKS	MODELLO / DESCRIZIONE MODEL / DESCRIPTION
0401536 	4419219 4419219 93197233 8200688877 401608374R	M=16x1,5 RHT	SNODO SOSPENSIONE - ASSE ANTERIORE - INFERIORE - BALL JOINT - FRONT AXLE - LOWER
0381536 	4419216 4419216 93197215 8200688875		BRACCIO OSCILLANTE - ASSE ANTERIORE - INFERIORE - TRACK CONTROL ARM - FRONT AXLE -LOWER
0391536 	4419215 4419215 93197214 8200688871		BRACCIO OSCILLANTE - ASSE ANTERIORE - INFERIORE - TRACK CONTROL ARM - FRONT AXLE -LOWER
1216016 	4419217 Z 4419217 Z 93197216 Z 8200688832 Z		SILENTBLOC CENTRALE - CENTRAL BUSHING
1216017 	4419218 Z 4419218 Z 93197232 Z 545601173R		SILENTBLOC ESTREMO - OUTER BUSHING
0501536 	4419291 4419291 93197325 546180004R	M=10x1,5 RHT	STABILIZZATORE - ASSE ANTERIORE - STABILIZER LINK - FRONT AXLE
0501496 	4419304 4419304 93197332 551100019R		STABILIZZATORE - ASSE POSTERIORE - STABILIZER LINK - REAR AXLE
0283875 	4408511 7701049283 4408511	L=209 M=14x1,5 RHT	TESTA STERZO - TIE ROD END
0293875 	4408510 7701049282	L=209 M=14x1,5 RHT	TESTA STERZO - TIE ROD END
0604424-K 	4408474 7701473333 4408474		KIT SNODO ASSIALE - AXIAL JOINT KIT







OPEL - VIVARO - 2001 > 2014

RIF. OCAP OCAP REF.	RIF. ORIG O.E. NUMBER	NOTE REMARKS	MODELLO / DESCRIZIONE MODEL / DESCRIPTION
0604424 	4408474 * 4408474 *	L=2631,5 RHT M=14x1,5 RHT	SNODO ASSIALE - AXIAL JOINT
0903807 	4408476 4408476 7701473334 91160038		KIT CUFFIA STERZO - STEERING BOOT KIT
1211589 	4408476 * 4408476 * 7701473334 *		CUFFIA STERZO - STEERING BOOT
0403877 	- -		SNODO SOSPENSIONE - CON KIT - SUSPENSION JOINT - WITH KIT
0783808 	4408959 8200247900 4408959 91166461		BRACCIO OSCILLANTE IN LAMIERA - ASSE ANTERIORE - PRESSED STEEL ARM - FRONT AXLE - >10/2006
0793808 	4408958 8200247898 4408958 91166462		BRACCIO OSCILLANTE IN LAMIERA - ASSE ANTERIORE - PRESSED STEEL ARM - FRONT AXLE - >10/2006
1215640 	- 8200002868		SILENTBLOC CENTRALE - CENTRAL BUSHING
1215641 	- 8200002869		SILENTBLOC ESTREMO - OUTER BUSHING
0404627 	4431869 7701477385 4431869 93161884		SNODO SOSPENSIONE - CON KIT - BALL JOINT - WITH KIT - 11/2006 >

OPEL - VIVARO - 2001 > 2014

RIF. OCAP OCAP REF.	RIF. ORIG O.E. NUMBER	NOTE REMARKS	MODELLO / DESCRIZIONE MODEL / DESCRIPTION
0384627 	4418226 8200876657 8200626961 8200395034 4418226 4417178 4421646 93862135 93853465		BRACCIO OSCILLANTE - ASSE ANTERIORE - TRACK CONTROL ARM - FRONT AXLE - 11/2006 >
0394627 	4418225 8200876659 8200626959 8200395007 4418225 4417177 4421647 9386136		BRACCIO OSCILLANTE - ASSE ANTERIORE - TRACK CONTROL ARM - FRONT AXLE - 11/2006 >
1215640 	- 8200002868		SILENTBLOC CENTRALE - CENTRAL BUSHING
1215641 	- 8200002869		SILENTBLOC ESTREMO - OUTER BUSHING
0503878 	4408904 8200002870 4408904		STABILIZZATORE - ASSE ANTERIORE - STABILIZER LINK - FRONT AXLE
0283875 	4408511 7701049283 4408511	L=209 M=14x1,5 RHT	TESTA STERZO - TIE ROD END
0293875 	4408510 7701049282	L=209 M=14x1,5 RHT	TESTA STERZO - TIE ROD END
0604424-K 	4408474 7701473333 4408474		KIT SNODO ASSIALE - AXIAL JOINT KIT
0604424 	4408474 * 4408474 *	L=2631,5 RHT M=14x1,5 RHT	SNODO ASSIALE - AXIAL JOINT
0903807 	4408476 4408476 7701473334 91160038		KIT CUFFIA STERZO - STEERING BOOT KIT









OPEL - VIVARO - 06/2014 >

RIF. OCAP OCAP REF.	RIF. ORIG O.E. NUMBER	NOTE REMARKS	MODELLO / DESCRIZIONE MODEL / DESCRIPTION
1211589 	4408476 * 4408476 * 7701473334 *		CUFFIA STERZO - STEERING BOOT
0403875 	4422270 * 4422270 * 545006069R *		SNODO SOSPENSIONE - CON KIT - SUSPENSION JOINT - WITH KIT
0383875 	4422270 4422270 545006069R		BRACCIO OSCILLANTE - ASSE ANTERIORE - TRACK CONTROL ARM - FRONT AXLE
0393875 	4422269 4422269 545019956R		BRACCIO OSCILLANTE - ASSE ANTERIORE - TRACK CONTROL ARM - FRONT AXLE
1215640 	- 8200002868		SILENTBLOC CENTRALE - CENTRAL BUSHING
1215641 	- 8200002869		SILENTBLOC ESTREMO - OUTER BUSHING
0503878 	4408904 8200002870 4408904		STABILIZZATORE - ASSE ANTERIORE - STABILIZER LINK - FRONT AXLE

PEUGEOT - BOXER - 1994 > 2006

RIF. OCAP OCAP REF.	RIF. ORIG O.E. NUMBER	NOTE REMARKS	MODELLO / DESCRIZIONE MODEL / DESCRIPTION
0281143 	1471655080 1306716080 1471655080 4018A3 4018H4	M=16x1,5 RHT	TESTA STERZO - TIE ROD END - > 12/2002
0282323 	77362278 77362278 4018E0	M=16x1,5 RHT	TESTA STERZO - TIE ROD END - > 01/2003 >
0601139 	4018A4 1471654080 400624 4018A4 9945836	M=16x1,5 RHT	SNODO ASSIALE - AXIAL JOINT
0900489 	400622 9946982 400622 401815		KIT CUFFIA STERZO - STERZO MANUALE - KIT STEERING BOOT - MANUAL STEERING
1211310 	4018A52 9946982 4018A5		CUFFIA STERZO - SERVOSTERZO - STEERING BOOT - POWER STEERING
0900449 	406635 9945837 406635		KIT CUFFIE STERZO - SERVOSTERZO - KIT STEERING BOOTS - POWER STEERING
0401137 	1302368080 1302368080 3640.32 364032		SNODO SOSPENSIONE - BALL JOINT - MOD. 1.0 - 1.4 t. > 01/ 2001
0381141 	1320787080 1308601080 1317241080 1320787080 352165 3521.65		BRACCIO OSCILLANTE - TRACK CONTROL ARM - MOD. 1.0 - 1.4 t. - > 01/2001
0391141 	1320786080 1308600080 1317240080 1320786080 352095 3520.95		BRACCIO OSCILLANTE - TRACK CONTROL ARM - MOD. 1.0 - 1.4 t. - > 01/2001









PEUGEOT - BOXER - 1994 > 2006

RIF. OCAP OCAP REF.	RIF. ORIG O.E. NUMBER	NOTE REMARKS	MODELLO / DESCRIZIONE MODEL / DESCRIPTION
0401446 	1331640080 1331640080 364055 3640.55		SNODO SOSPENSIONE - BALL JOINT - MOD. 1.0 - 1.4 t. - 02/2001 >
0381446 	1331940080 1339467080 1331940080 3521J3 3521.J3		BRACCIO OSCILLANTE - TRACK CONTROL ARM - MOD. 1.0 - 1.4 t. - 02/2001 >
0391446 	1331938080 1339465080 1331938080 3520N3 3520.N3		BRACCIO OSCILLANTE - TRACK CONTROL ARM - MOD. 1.0 - 1.4 t. - 02/2001 >
0401138 	1300473080 1300473080 364033 3640.33		SNODO SOSPENSIONE - BALL JOINT - MOD. 1.8 t - > 01/2001
0381140 	1320756080 1308760080 1317239080 1320756080 352166 3521.66		BRACCIO OSCILLANTE - TRACK CONTROL ARM - MOD. 1.8 t - > 01/2001
0391140 	1320755080 1320755080 1317238080 1308759080 352096 3520.96		BRACCIO OSCILLANTE - TRACK CONTROL ARM - MOD. 1.8 t - > 01/2001
0401451 	1331641080 1331641080 364054 3640.54		SNODO SOSPENSIONE - BALL JOINT - MOD. 1.8 t - 02/2001 >
0381451 	1331939080 1339466080 1331939080 3521J4 3521.J4		BRACCIO OSCILLANTE - TRACK CONTROL ARM - MOD. 1.8 t - 02/2001 >











PEUGEOT - BOXER - 1994 > 2006

RIF. OCAP OCAP REF.	RIF. ORIG O.E. NUMBER	NOTE REMARKS	MODELLO / DESCRIZIONE MODEL / DESCRIPTION
0391451 	1331937080 1339464080 1331937080 3520N4 3520.N4		BRACCIO OSCILLANTE - TRACK CONTROL ARM - MOD. 1.8 t - 02/2001 >
1215176 	- -		SILENTBLOC CENTRALE - CENTRAL BUSHING
1215177 	- -		SILENTBLOC ESTREMO - OUTER BUSHING
0181602 	1300716080 1300716080		PUNTONE BARRA STABILIZZATRICE - STABILIZER LINK
0181602-K 	- 1300716080 15503811 1300721080 1300720080		KIT PUNTONE BARRA STABILIZZATRICE - STABILIZER LINK KIT
0282637 	381770 381770 77364009	M=16x1,5 RHT	TESTA STERZO - TIE ROD END
0292637 	381777 381777 77364253	M=16x1,5 RHT	TESTA STERZO - TIE ROD END
0602637 	4000SF * 4000SF * 4000SG * 1341019080 * 1345854080 *	M=16x1,5 RHT	SNODO ASSIALE - AXIAL JOINT
0902637 	406686 406686 77364254		KIT CUFFIA STERZO - STEERING BOOT KIT
0402638 	364067 364067 50705629		SNODO SOSPENSIONE - ASSE ANTERIORE - BALL JOINT - FRONT AXLE - MOD. Q11-Q15-Q17L-Q17Q-Q20









PEUGEOT - BOXER - 2006 >

RIF. OCAP OCAP REF.	RIF. ORIG O.E. NUMBER	NOTE REMARKS	MODELLO / DESCRIZIONE MODEL / DESCRIPTION
0382638 	3521P1 3521P1 1352225080		BRACCIO OSCILLANTE - ASSE ANTERIORE - INFERIORE - TRACK CONTROL ARM FRONT AXLE - LOWER - MOD. Q11- Q15-Q17L
0392638 	3520S0 3520S0 1352227080		BRACCIO OSCILLANTE - ASSE ANTERIORE - INFERIORE - TRACK CONTROL ARM FRONT AXLE - LOWER - MOD. Q11- Q15-Q17L
0382639 	3521P2 3521P2 1352226080		BRACCIO OSCILLANTE - ASSE ANTERIORE - INFERIORE - TRACK CONTROL ARM FRONT AXLE - LOWER - MOD. Q17H- Q20
0392639 	3520S1 3520S1 1352228080		BRACCIO OSCILLANTE - ASSE ANTERIORE - INFERIORE - TRACK CONTROL ARM FRONT AXLE - LOWER - MOD. Q17H- Q20
1215822 	- -		SILENTBLOC CENTRALE - CENTRAL BUSHING
1215823 	- -		SILENTBLOC ESTREMO - OUTER BUSHING
0182638 	5081N9 Z 1350658080 Z 1357572080 Z 5081N9 Z		STABILIZZATORE - ASSE ANTERIORE - STABILIZER LINK - FRONT AXLE
0503520 	1355449080 Z 1355449080 Z		STABILIZZATORE - ASSE POSTERIORE - STABILIZER LINK - REAR AXLE
0280037 	405909 405909 9404059080 1306003080 4322906 3265974	M=14x1,5 RHT	TESTA STERZO - TIE ROD END











PEUGEOT - EXPERT - 1995 > 2006

RIF. OCAP OCAP REF.	RIF. ORIG O.E. NUMBER	NOTE REMARKS	MODELLO / DESCRIZIONE MODEL / DESCRIPTION
0600918 	3812A4 3812A4 9566950880	M=14x1,5 RHT	SNODO ASSIALE - AXIAL JOINT
0381184 	352164 71737048 1313084080 1333755080 1322664080 1317390080 1316736080		BRACCIO OSCILLANTE - TRACK CONTROL ARM
0391184 	352094 71737047 1313083080 1333754080 1322663080 1317389080 1316735080		BRACCIO OSCILLANTE - TRACK CONTROL ARM
1215173 	- -		SILENTBLOCK CENTRALE - CENTRAL BUSHING
1215174 	- -		SILENTBLOCK ESTREMO - DX - OUTER BUSHING - RH
1215175 	- -		SILENTBLOCK ESTREMO - SX - OUTER BUSHING - LH
0181322-K 	508735 * 1308664080 * 15503811 * 1311025080 * 1313056080 * 508735 *		KIT PUNTONE BARRA STABILIZZATRICE - STABILIZER LINK KIT
0181322 	508735 508735		PUNTONE BARRA STABILIZZATRICE - STABILIZER LINK
0282733 	381773 381773 9403817738	M=14x1,5 RHT	TESTA STERZO - TIE ROD END
0602733 	3812F0 3812F0 1497552080 1401381380	M=14x1,5 RHT	SNODO ASSIALE STERZO - AXIAL JOINT

PEUGEOT - EXPERT - 2007 >

RIF. OCAP OCAP REF.	RIF. ORIG O.E. NUMBER	NOTE REMARKS	MODELLO / DESCRIZIONE MODEL / DESCRIPTION
1211477 	406683 * 406683 * 9404066838 *		CUFFIA STERZO - STEERING GAITER
0902733 	406683 406683 9404066838		KIT CUFFIA STERZO - STEERING GAITER KIT
0382734 	3521N9 3521N9 1497407080		BRACCIO OSCILLANTE - TRACK CONTROL ARM
0392734 	3520R8 3520R8 1497408080		BRACCIO OSCILLANTE - TRACK CONTROL ARM
1215646 	- -		SILENTBLOCK ESTREMO - DX - OUTER BUSHING - RH
1215647 	- -		SILENTBLOCK ESTREMO - SX - OUTER BUSHING - LH
1215870 	- -		SILENTBLOCK CENTRALE - CENTRAL BUSHING
0502735 	508756 508756 1400099680		STABILIZZATORE - ASSE ANTERIORE - STABILIZER LINK - FRONT AXLE











RENAULT - MASTER - 1981 > 1998

RIF. OCAP OCAP REF.	RIF. ORIG O.E. NUMBER	NOTE REMARKS	MODELLO / DESCRIZIONE MODEL / DESCRIPTION
0282240 	7701462427 7701462427	L=100 M=16x1,5 RHT	TESTA STERZO - TIE ROD END
0402241 	7701462692 7701462692	M=16x1,5 RHT	SNODO SOSPENSIONE SUPERIORE - BALL JOINT UPPER
0402242 	7701462693 7701462693	M=16x1,5 RHT	SNODO SOSPENSIONE INFERIORE - BALL JOINT LOWER
0281495 	7701470364 7701470364 48520-00QAJ 4501263 9161563	L=222 M=16x1,5 RHT	TESTA STERZO - TIE ROD END
0291495 	7701470363 7701470363 48520-00QAH 4501262 9161562	L=222 M=16x1,5 RHT	TESTA STERZO - TIE ROD END
0603811 	- - 48521-00QAF	M=16x1,5 RHT	SNODO ASSIALE STERZO - AXIAL JOINT
0603811-K 	7701470362 7701470362		SNODO ASSIALE CON KIT - AXIAL JOINT KIT
1211392 	7701470361 4501260 Z 9161560 Z 6001547607 7701470361 6025370231		CUFFIA STERZO - STEERING BOOT
0401494 	7700312852 7700312852 40160-00QAD 4500255 9160555		SNODO SOSPENSIONE - SUSPENSION JOINT
0381494 	7700309190 7700309190 54500-00QAC 4404048 54500-00QAD 4500093 54500-00QAE 9160393 4418213		BRACCIO OSCILLANTE - TRACK CONTROL ARM











RENAULT - MASTER - 1998 >

RIF. OCAP OCAP REF.	RIF. ORIG O.E. NUMBER	NOTE REMARKS	MODELLO / DESCRIZIONE MODEL / DESCRIPTION
0391494 	7700309189 7700309189 54501-00QAC 4500092 54501-00QAD 9160392 54501-00QAE 4418212		BRACCIO OSCILLANTE - TRACK CONTROL ARM
1215609 	7700302122 7700302122 54570-00QAA 4500094 9160394		SILENTBLOC CENTRALE - CENTRAL BUSHING
1215610 	7700302123 7700302123 54423-00QAA 4500095 9160395		SILENTBLOC ESTREMO - OUTER BUSHING
0401522 	7700312851 7700312851 40160-00QAB	M=14x1,5 RHT	SNODO SOSPENSIONE BRACCIO SUPERIORE - LATO ESTERNO - BALL JOINT UPPER CONTROL ARM - OUTER SIDE
0401523 	7701056970 4401910 4500090		SNODO SOSPENSIONE BRACCIO SUPERIORE - LATO INTERNO - BALL JOINT UPPER CONTROL ARM - INNER SIDE
0583812 	7700309071 54618-00QAA 7700309071 7700307343 4500199 9160499		STABILIZZATORE - ASSE ANTERIORE - STABILIZER LINK - FRONT AXLE
0593812 	7700309070 54618-00QAB 7700309070 7700302165 4500198 9160498		STABILIZZATORE - ASSE ANTERIORE - STABILIZER LINK - FRONT AXLE
0281536 	485200780R 4420098 93167689 485200780R	M=18x1,5 RHT	TESTA STERZO - TIE ROD END
0291536 	485206730R 4420097 93167688 485206730R	M=18x1,5 RHT	TESTA STERZO - TIE ROD END
0901536 	485212373R 4420096 93167687 485212373R	M=18x1,5 RHT	KIT SNODO ASSIALE - AXIAL JOINT KIT

RENAULT - MASTER III - 02/2010 >

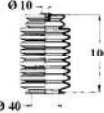
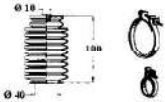
RIF. OCAP OCAP REF.	RIF. ORIG O.E. NUMBER	NOTE REMARKS	MODELLO / DESCRIZIONE MODEL / DESCRIPTION
0601536 	485212373R 4420096 Z 93167687 Z 485212373R	M=18x1,5 RHT	SNODO ASSIALE - AXIAL JOINT
0903811 	6000025546 Z 4501260 9161560 6000025546 Z 6025370231 Z		KIT CUFFIA STERZO - STEERING BOOT KIT
1211392 	6001547607 4501260 Z 9161560 Z 6001547607 7701470361 6025370231		CUFFIA STERZO - STEERING BOOT
0401536 	8200688877 4419219 93197233 8200688877 401608374R	M=16x1,5 RHT	SNODO SOSPENSIONE - ASSE ANTERIORE - INFERIORE - BALL JOINT - FRONT AXLE - LOWER
0381536 	8200688875 4419216 93197215 8200688875		BRACCIO OSCILLANTE - ASSE ANTERIORE - INFERIORE - TRACK CONTROL ARM - FRONT AXLE - LOWER
0391536 	8200688871 4419215 93197214 8200688871		BRACCIO OSCILLANTE - ASSE ANTERIORE - INFERIORE - TRACK CONTROL ARM - FRONT AXLE - LOWER
1216016 	8200688832 4419217 Z 93197216 Z 8200688832 Z		SILENTBLOC CENTRALE - CENTRAL BUSHING
1216017 	545601173R 4419218 Z 93197232 Z 545601173R		SILENTBLOC ESTREMO - OUTER BUSHING
0501536 	546180004R 4419291 93197325 546180004R	M=10x1,5 RHT	STABILIZZATORE - ASSE ANTERIORE - STABILIZER LINK - FRONT AXLE
0501496 	551100019R 4419304 93197332 551100019R		STABILIZZATORE - ASSE POSTERIORE - STABILIZER LINK - REAR AXLE

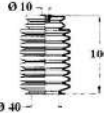
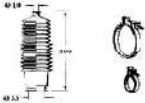









RENAULT - TRAFIC I - 1980 > 1998

RIF. OCAP OCAP REF.	RIF. ORIG O.E. NUMBER	NOTE REMARKS	MODELLO / DESCRIZIONE MODEL / DESCRIPTION
0502230 	7701463035 7701463035		BARRA STERZO CON KIT - TIE ROD WITH KIT ASSEMBLY - > 09/1981
0180947 	7701461770 7701461770	M=14x1,5 RHT	TESTA STERZO - TIE ROD END
0602230 	- -	M=14x1,5 RHT	SNODO ASSIALE - CON KIT - KIT AXIAL JOINT
0502231 	7701462987 7701462987		BARRA STERZO CON KIT - TIE ROD WITH KIT ASSEMBLY - 10/1981
0180947 	7701461770 7701461770	M=14x1,5 RHT	TESTA STERZO - TUTTI I MODELLI - TIE ROD END - FOR ALL MODELS - RHT M14x1.5
0602231 	- -	M=14x1,5 RHT	SNODO ASSIALE - CON KIT - KIT AXIAL JOINT
1211267 	7700774566 7700774566		CUFFIA STERZO - STERZO MANUALE - SINGLE STEERING BOOT - MANUAL STEERING - > 1989
0902231 	- -		KIT CUFFIE STERZO - STERZO MANUALE - KIT STEERING BOOTS - MANUAL STEERING - > 1989
1211128 	7700680852 7700680852		CUFFIA STERZO - STERZO MANUALE - SINGLE STEERING BOOT - MANUAL STEERING - 1989 >
1211267 	7700774566 7700774566		CUFFIA STERZO - STERZO MANUALE - SINGLE STEERING BOOT - MANUAL STEERING - > 1989
0902230 	- -		KIT CUFFIE STERZO - STERZO MANUALE - KIT STEERING BOOTS - MANUAL STEERING - 1989 >
1211123 	7700706007 7700706007		CUFFIA STERZO - SERVOSTERZO - SINGLE STEERING BOOT - POWER STEERING











RENAULT - TRAFIC I - 1980 > 1998

RIF. OCAP OCAP REF.	RIF. ORIG O.E. NUMBER	NOTE REMARKS	MODELLO / DESCRIZIONE MODEL / DESCRIPTION
0402235 	7701461667 7701461667	M=16x1,5 RHT	SNODO SOSPENSIONE INFERIORE - SUSPENSION JOINT LOWER
0283875 	7701049283 7701049283 4408511	L=209 M=14x1,5 RHT	TESTA STERZO - TIE ROD END
0293875 	7701049282 7701049282	L=209 M=14x1,5 RHT	TESTA STERZO - TIE ROD END
0604424-K 	7701473333 7701473333 4408474		KIT SNODO ASSIALE - AXIAL JOINT KIT
0604424 	- 4408474 *	L=2631,5 RHT M=14x1,5 RHT	SNODO ASSIALE - AXIAL JOINT
0903807 	7701473334 4408476 7701473334 91160038		KIT CUFFIA STERZO - STEERING BOOT KIT
0403877 	- -		SNODO SOSPENSIONE - CON KIT - SUSPENSION JOINT - WITH KIT
0783808 	8200247900 8200247900 4408959 91166461		BRACCIO OSCILLANTE IN LAMIERA - ASSE ANTERIORE - PRESSED STEEL ARM - FRONT AXLE - >10/2006
0793808 	8200247898 8200247898 4408958 91166462		BRACCIO OSCILLANTE IN LAMIERA - ASSE ANTERIORE - PRESSED STEEL ARM - FRONT AXLE - >10/2006
1215640 	- 8200002868		SILENTBLOC CENTRALE - CENTRAL BUSHING





RENAULT - TRAFIC II - 03/2001 >

RIF. OCAP OCAP REF.	RIF. ORIG O.E. NUMBER	NOTE REMARKS	MODELLO / DESCRIZIONE MODEL / DESCRIPTION
1215641 	- 8200002869		SILENTBLOC ESTREMO - OUTER BUSHING
0404627 	7701477385 7701477385 4431869 93161884		SNODO SOSPENSIONE - CON KIT - BALL JOINT - WITH KIT - 11/2006 >
0384627 	8200876657 8200876657 8200626961 8200395034 4418226 4417178 4421646 93862135 93853465		BRACCIO OSCILLANTE - ASSE ANTERIORE - TRACK CONTROL ARM - FRONT AXLE - 11/2006 >
0394627 	8200876659 8200876659 8200626959 8200395007 4418225 4417177 4421647 9386136		BRACCIO OSCILLANTE - ASSE ANTERIORE - TRACK CONTROL ARM - FRONT AXLE - 11/2006 >
1215641 	- 8200002869		SILENTBLOC ESTREMO - OUTER BUSHING
1215640 	- 8200002868		SILENTBLOC CENTRALE - CENTRAL BUSHING
0503878 	8200002870 8200002870 4408904		STABILIZZATORE - ASSE ANTERIORE - STABILIZER LINK - FRONT AXLE
0283875 	7701049283 7701049283 4408511	L=209 M=14x1,5 RHT	TESTA STERZO - TIE ROD END
0293875 	7701049282 7701049282	L=209 M=14x1,5 RHT	TESTA STERZO - TIE ROD END
0604424-K 	7701473333 7701473333 4408474		KIT SNODO ASSIALE - AXIAL JOINT KIT









RENAULT - TRAFIC III - 05/2014 >

RIF. OCAP OCAP REF.	RIF. ORIG O.E. NUMBER	NOTE REMARKS	MODELLO / DESCRIZIONE MODEL / DESCRIPTION
0604424 	- 4408474 *	L=2631,5 RHT M=14x1,5 RHT	SNODO ASSIALE - AXIAL JOINT
0903807 	7701473334 4408476 7701473334 91160038		KIT CUFFIA STERZO - STEERING BOOT KIT
1211589 	7701473334 * 4408476 * 7701473334 *		CUFFIA STERZO - STEERING BOOT
0403875 	545006069R * 4422270 * 545006069R *		SNODO SOSPENSIONE - CON KIT - SUSPENSION JOINT - WITH KIT
0383875 	505006069R 4422270 545006069R		BRACCIO OSCILLANTE - ASSE ANTERIORE - TRACK CONTROL ARM - FRONT AXLE
0393875 	505019956R 4422269 545019956R		BRACCIO OSCILLANTE - ASSE ANTERIORE - TRACK CONTROL ARM - FRONT AXLE
1215640 	8200002868 8200002868		SILENTBLOC CENTRALE - CENTRAL BUSHING
1215641 	8200002869 8200002869		SILENTBLOC ESTREMO - OUTER BUSHING
0503878 	8200002870 8200002870 4408904		STABILIZZATORE - ASSE ANTERIORE - STABILIZER LINK - FRONT AXLE
0181401 	7701013272 7701013272	M=16x1,5 RHT	TESTA STERZO - TIE ROD END











RENAULT - SG2 - SG4

RIF. OCAP OCAP REF.	RIF. ORIG O.E. NUMBER	NOTE REMARKS	MODELLO / DESCRIZIONE MODEL / DESCRIPTION
0191401 	7701013276 7701013276	M=16x1,5 LHT	TESTA STERZO - TIE ROD END
0400951 	5000246731 5000246731	M=18x1,5 RHT	SNODO SOSPENSIONE - SUPERIORE - UPPER BALL JOINT - MOD. SG2
0400952 	5000246732 5000246732	M=20x1,5 RHT	SNODO SOSPENSIONE - INFERIORE - LOWER BALL JOINT - MOD. SG2
0401398 	5000246729 5000246729	M=20x1,5 RHT	SNODO SOSPENSIONE - SUPERIORE - UPPER BALL JOINT - MOD. SG4
0401399 	5000246730 5000246730	M=24x1,5 RHT	SNODO SOSPENSIONE - INFERIORE - LOWER BALL JOINT - MOD. SG2











VOLKSWAGEN - CRAFTER - 2006 >

RIF. OCAP OCAP REF.	RIF. ORIG O.E. NUMBER	NOTE REMARKS	MODELLO / DESCRIZIONE MODEL / DESCRIPTION
0282717 	2E0713501 9064600048	M=16x1,5 RHT	TESTA STERZO - TIE ROD END
0602741-K 	2E0713491 9064600055		KIT SNODO ASSIALE - AXIAL JOINT KIT
0602741 	- -	M=16x1,5 RHT	SNODO ASSIALE - AXIAL JOINT
0902741 	2E0713115 9064600096		KIT CUFFIA STERZO - STEERING BOOT KIT
1211481 	- -		CUFFIA STERZO - STEERING BOOT KIT
0402742 	- -		SNODO SOSPENSIONE - ASSE ANTERIORE - BALL JOINT - FRONT AXLE
0782742 	2E0407152M 2E0407152M		BRACCIO OSCILLANTE - ASSE ANTERIORE - TRACK CONTROL ARM - FRONT AXLE
0792742 	2E0407151M 9063304007		BRACCIO OSCILLANTE - ASSE ANTERIORE - TRACK CONTROL ARM - FRONT AXLE
1215874 	2E0407523 9063330014		SILENTBLOC - BUSHING













VOLKSWAGEN - CRAFTER - 2006 >

RIF. OCAP OCAP REF.	RIF. ORIG O.E. NUMBER	NOTE REMARKS	MODELLO / DESCRIZIONE MODEL / DESCRIPTION
0582743 	2E0411318C 9063201889		STABILIZZATORE - ASSE ANTERIORE - STABILIZER LINK - FRONT AXLE
0592743 	2E0411317C 9063201789		STABILIZZATORE - ASSE ANTERIORE - STABILIZER LINK - FRONT AXLE
0502744 	2E0511051F 6013201389		STABILIZZATORE - ASSE POSTERIORE - STABILIZER LINK - REAR AXLE
1215817 	2E0511051F 6013210350		SILENTBLOC STABILIZZATORE - ASSE POSTERIORE - STABILIZER LINK BUSHING - REAR AXLE
0501503  0281503 M=16x1,5 RHT	2D0422803 9014600205 2D0422803		BARRA STERZO - SCATOLA GUIDA - TIE ROD - STEERING BOX
0281503 	2D0422811 9014600348 9014600048 9014600148 2D0422811	L=76 M=16x1,5 RHT	TESTA STERZO - SCATOLA GUIDA - TIE ROD END - STEERING BOX
0601504 	9014600455 9014600155 9014600255 9014600455 2D0422803	M=16x1,5 RHT	SNODO ASSIALE - SCATOLA GUIDA - AXIAL JOINT - STEERING BOX
1211400 	2D0422831 2D0422831		CUFFIA STERZO - STEERING BOOT
0901504 	2D0498831 9014605500 2D0498831		KIT CUFFIA STERZO - STEERING BOOT KIT
0401505 	2D0407361A 9013331227 9013331127 9013331027 9013330727 9013330627 2D0407361A	M=20x1,5	SNODO SOSPENSIONE ASSE ANTERIORE - BALL JOINT FRONT AXLE











VOLKSWAGEN - LT 28-35-46 - 1996 >

RIF. OCAP OCAP REF.	RIF. ORIG O.E. NUMBER	NOTE REMARKS	MODELLO / DESCRIZIONE MODEL / DESCRIPTION
0781505 	2D0407022B 9013302507 9013301907 2D0407022B 2D0407022		BRACCIO OSCILLANTE - ANTERIORE - TRACK CONTROL ARM - FRONT
0791505 	2D0407021B 9013301807 2D0407021B 2D0407021		BRACCIO OSCILLANTE - ANTERIORE - TRACK CONTROL ARM - FRONT
1215705 	2D0407140 9013330214 2D0407140		SILENTBLOC - BUSHING
0581514 	2D0411052 9013200389 2D0411052		STABILIZZATORE - ASSE ANTERIORE - CON SILENTBLOC - STABILIZER LINK- FRONT AXLE - WITH BUSHING
0591514 	2D0411051 9013200289 2D0411051		STABILIZZATORE - ASSE ANTERIORE - CON SILENTBLOC - STABILIZER LINK- FRONT AXLE - WITH BUSHING
0104151 	2D0511329 2D0511329 9013200089	L=95	STABILIZZATORE - ASSE POSTERIORE - STABILIZER LINK - REAR AXLE
0501501 	251419803A 251419803 251419803A		BARRA STERZO - TIE ROD
0280056 	251419811 251419811 171419811		TESTA STERZO - TIE RODEND - RHT M14x1,5
0600887 	- -		SNODO ASSIALE - AXIAL JOINT - RHT M14x1,5
1211142 	251419831A 251419831A		CUFFIA STERZO - STEERING BOOT
0902079 	- -		KIT CUFFIA STERZO - STEERING BOOT KIT













VOLKSWAGEN - TRANSPORTER T3 - 1979 >

RIF. OCAP OCAP REF.	RIF. ORIG O.E. NUMBER	NOTE REMARKS	MODELLO / DESCRIZIONE MODEL / DESCRIPTION
0400888 	251407361 251407361		SNODO SOSPENSIONE - ASSE ANTERIORE - SUPERIORE - BALL JOINT - FRONT AXLE - UPPER
0400889 	251407187A 251407187A		SNODO SOSPENSIONE - ASSE ANTERIORE - INFERIORE - BALL JOINT - FRONT AXLE - LOWER -PRIMO MONTAGGIO - EARLY - 48.3 mm.
0404001 	251407187C 251407187C		SNODO SOSPENSIONE - ASSE ANTERIORE - INFERIORE - BALL JOINT - FRONT AXLE - LOWER -RICAMBIO - LATE - 48.6 mm.
1214127 	251411041C 251411041C		SILENTBLOC - BARRA STABILIZZATRICE - ASSE ANTERIORE - STABILIZING BAR BUSHING -FRONT AXLE - DIAM. 20 mm.
1215659 	701407087 701407087		SILENTBLOC - ASSE POSTERIORE - SUPERIORE - BUSHING - REAR AXLE - UPPER
0581405 	701419804C 701419804C		L H D - BARRA STERZO - TIE ROD - > CH. 70-T-199 999
0591405 	701419803C 701419803C		L H D - BARRA STERZO - TIE ROD - > CH. 70-T-199 999
0581406 	702419804A 702419804A		R H D - BARRA STERZO - TIE ROD - > CH. 70-M-096448
0591406 	702419803A 702419803A		R H D - BARRA STERZO - TIE ROD - > CH. 70-M-096448
0281405 	701419812 701419812		TESTA STERZO - TIE ROD END - > CH. 70-M-096448
0291405 	701419811A 701419811A		TESTA STERZO - TIE ROD END - > CH. 70-M-096448
0581407 	701419804D 701419804D 702419804B		L H D - BARRA STERZO - TIE ROD - CH. 70-M-096 449 > 70-S- 002 791













VOLKSWAGEN - TRANSPORTER T4 - 1990 >

RIF. OCAP OCAP REF.	RIF. ORIG O.E. NUMBER	NOTE REMARKS	MODELLO / DESCRIZIONE MODEL / DESCRIPTION
0591407 	701419803D 701419803D 702419803B		L H D - BARRA STERZO - TIE ROD - CH. 70-M-096 449 > 70-S-002 791
0581407 	702419804B 701419804D 702419804B		R H D - BARRA STERZO - TIE ROD - CH. 70-M-096 449 > 70-S-002 791
0591407 	702419803B 701419803D 702419803B		R H D - BARRA STERZO - TIE ROD - CH. 70-M-096 449 > 70-S-002 791
0281407 	701419812A 701419812A		TESTA STERZO - TIE ROD END - CH. 70-M-096 449 > 70-S-002 791
0291407 	701419811B 701419811B		TESTA STERZO - TIE ROD END - CH. 70-M-096 449 > 70-S-002 791
0601412 	- -		SNODO ASSIALE - AXIAL JOINT
0601406 	- -		SNODO ASSIALE - AXIAL JOINT
0401409 	701407187B 701407187B 701407187A		SNODO SOSPENSIONE - SUPERIORE - BALL JOINT - UPPER
0401410 	701407361B 701407361B		SNODO SOSPENSIONE - INFERIORE - BALL JOINT - LOWER
1215660 	701407077A 701407077A		SILENTBLOC SOSPENSIONE ANTERIORE - SUPERIORE - FRONT SUSPENSION BUSHING - UPPER
1215661 	7D0407183 7D0407183 701407183C		SILENTBLOC SOSPENSIONE ANTERIORE - INFERIORE - FRONT SUSPENSION BUSHING - LOWER
0501443 	7D0411049 7D0411049 701411049		STABILIZZATORE - ASSE ANTERIORE - STABILIZER LINK - FRONT AXLE - DIAM.23 mm.













VOLKSWAGEN - TRANSPORTER T4 - 1990 >

RIF. OCAP OCAP REF.	RIF. ORIG O.E. NUMBER	NOTE REMARKS	MODELLO / DESCRIZIONE MODEL / DESCRIPTION
0503864 	701411049B 701411049B		STABILIZZATORE - ASSE ANTERIORE - STABILIZER LINK - FRONT AXLE - DIAM.27 mm.
1215671 	- -		SILENTBLOC STABILIZZATORE - STABILIZER LINK BUSHING
1214105 	701411041 701411041		SILENTBLOC BARRA STABILIZZATRICE - STABILIZING BAR BUSHING - DIAM. 23 mm.
1214109 	7D0411045 7D0411045		SILENTBLOC BARRA STABILIZZATRICE - STABILIZING BAR BUSHING - DIAM. 28,5 mm.
1214270 	701411041D 701411041D		SILENTBLOC BARRA STABILIZZATRICE - STABILIZING BAR BUSHING - DIAM. 27 mm.
1214276 	7D1411041 7D1411041		SILENTBLOC BARRA STABILIZZATRICE - STABILIZING BAR BUSHING - DIAM. 23 mm.
1215662 	701501131 701501131		SILENTBLOC ASSE POSTERIORE - ESTERNO - REAR SUSPENSION BUSHING - OUTER
1215663 	7D0407140A 7D0407140A 7D0407140 701407140C 701407140B		SILENTBLOC ASSE POSTERIORE - INFERIORE - REAR SUSPENSION BUSHING - LOWER
0581411 	701419804E 701419804E		L H D - BARRA STERZO - TIE ROD - > CH. 70-T-199 999
0591411 	701419803E 701419803E		L H D - BARRA STERZO - TIE ROD - > CH. 70-T-199 999
0581412 	702419804C 702419804C		R H D - BARRA STERZO - TIE ROD - > CH. 70-T-199 999
0591412 	702419803C 702419803C		R H D - BARRA STERZO - TIE ROD - > CH. 70-T-199 999











VOLKSWAGEN - TRANSPORTER T4 - 1990 > -

RIF. OCAP OCAP REF.	RIF. ORIG O.E. NUMBER	NOTE REMARKS	MODELLO / DESCRIZIONE MODEL / DESCRIPTION
0281411 	701419812B 701419812B		TESTA STERZO - TIE ROD END - > CH. 70-T-199 999
0291411 	701419811C 701419811C		TESTA STERZO - TIE ROD END - > CH. 70-T-199 999
0601412 	- -		SNODO ASSIALE - AXIAL JOINT
0601406 	- -		SNODO ASSIALE - AXIAL JOINT - > CH. 70-T-199 999
0581413 	701419804F 701419804F		BARRA STERZO - TIE ROD - CH. 70-T-200 000 >
0591413 	702419803D 702419803D		BARRA STERZO - TIE ROD - CH. 70-T-200 000 >
0281413 	701419812D 701419812D		TESTA STERZO - TIE ROD END - CH. 70-T-200 000 >
0291413 	701419811E 701419811E		TESTA STERZO - TIE ROD END - CH. 70-T-200 000 >
0601412 	- -		SNODO ASSIALE - AXIAL JOINT
0401409 	701407187B 701407187B 701407187A		SNODO SOSPENSIONE - SUPERIORE - BALL JOINT - UPPER
0401410 	701407361B 701407361B		SNODO SOSPENSIONE - INFERIORE - BALL JOINT - LOWER - CH. > 70-T-199 999
0401425 	7D0407361 7D0407361		SNODO SOSPENSIONE - INFERIORE - BALL JOINT - LOWER - CH. 70-T-200 000 >



VOLKSWAGEN - TRANSPORTER T4 - 1990 > -

RIF. OCAP OCAP REF.	RIF. ORIG O.E. NUMBER	NOTE REMARKS	MODELLO / DESCRIZIONE MODEL / DESCRIPTION
1215660 	701407077A 701407077A		SILENTBLOC SOSPENSIONE ANTERIORE - SUPERIORE - FRONT SUSPENSION BUSHING - UPPER
1215661 	7D0407183 7D0407183 701407183C		SILENTBLOC SOSPENSIONE ANTERIORE - INFERIORE - FRONT SUSPENSION BUSHING - LOWER
0501443 	7D0411049 7D0411049 701411049		STABILIZZATORE - ASSE ANTERIORE - STABILIZER LINK - FRONT AXLE - DIAM.23 mm.
0503864 	701411049B 701411049B		STABILIZZATORE - ASSE ANTERIORE - STABILIZER LINK - FRONT AXLE - DIAM.27 mm.
1215671 	- -		SILENTBLOC STABILIZZATORE - STABILIZER LINK BUSHING
1214105 	701411041 701411041		SILENTBLOC BARRA STABILIZZATRICE - STABILIZING BAR BUSHING - DIAM. 23 mm.
1214109 	7D0411045 7D0411045		SILENTBLOC BARRA STABILIZZATRICE - STABILIZING BAR BUSHING - DIAM. 28,5 mm.
1214270 	701411041D 701411041D		SILENTBLOC BARRA STABILIZZATRICE - STABILIZING BAR BUSHING - DIAM. 27 mm.
1214276 	7D1411041 7D1411041		SILENTBLOC BARRA STABILIZZATRICE - STABILIZING BAR BUSHING - DIAM. 23 mm.
1215662 	701501131 701501131		SILENTBLOC ASSE POSTERIORE - ESTERNO - REAR SUSPENSION BUSHING - OUTER
1215663 	7D0407140A 7D0407140A 7D0407140 701407140C 701407140B		SILENTBLOC ASSE POSTERIORE - INFERIORE - REAR SUSPENSION BUSHING - LOWER
0584333 	7H0419804D 7H0419804D 7H0419804E		BARRA STERZO - TIE ROD



VOLKSWAGEN - TRANSPORTER T5 - 2003 >

RIF. OCAP OCAP REF.	RIF. ORIG O.E. NUMBER	NOTE REMARKS	MODELLO / DESCRIZIONE MODEL / DESCRIPTION
0594333 	7H0419803D 7H0419803D 7H0419803E		BARRA STERZO - TIE ROD
0284333 	7H0422818D 7H0422818D 7H0422818C 7H0422818B 7H0422818A		TESTA STERZO - TIE ROD END - RHT M16x1,5
0294333 	7H0422817D 7H0422817D 7H0422817C 7H0422817B 7H0422817A		TESTA STERZO - TIE ROD END - RHT M16x1,5
0604334 	- -		SNODO ASSIALE - AXIAL JOINT - RHT M16x1,5
1211430 	7H0422831 7H0422831		CUFFIA STERZO - STEERING BOOT
0404336 	7H0407361 7H0407361		SNODO SOSPENSIONE - BALL JOINT - MOD: (FURGONATI - VAN) 2,6-3,0 T - MOD: (PIANALE PIATTO - CHASSIS CAB) 2,6-2,85 T
0404335 	7H8407361A 7H8407361A 7H8407361		SNODO SOSPENSIONE - BALL JOINT - MOD: (FURGONATI - VAN) 3,2 T - MOD: (PIANALE PIATTO- CHASSIS CAB) 3,0-3,2 T
0382723 	7H0407152F 7H0407152F 7H0407152G 7H0407152E		BRACCIO OSCILLANTE - ASSE ANTERIORE - INFERIORE - TRACK CONTROL ARM - FRONT AXLE - LOWER
0392723 	7H0407151F 7H0407151F 7H0407151G 7H0407151E		BRACCIO OSCILLANTE - ASSE ANTERIORE - INFERIORE - TRACK CONTROL ARM - FRONT AXLE - LOWER
1215873 	7H0407183 7H0407183		SILENTBLOC CENTRALE - CENTRAL BUSHING







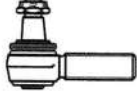
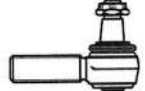
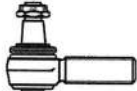
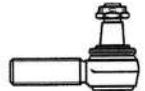

VOLKSWAGEN - TRANSPORTER T5 - 2003 >

RIF. OCAP OCAP REF.	RIF. ORIG O.E. NUMBER	NOTE REMARKS	MODELLO / DESCRIZIONE MODEL / DESCRIPTION
1215872 	7H0407182A 7H0407182A		SILENTBLOC ESTREMO - OUTER BUSHING
0504337 	7H5411317A 7H5411317A 7H5411317		STABILIZZATORE - ASSE ANTERIORE - STABILIZER LINK - FRONT AXLE









TESTE STERZO - TIE RODS END

RIF. OCAP OCAP REF.	RIF. ORIG O.E. NUMBER	NOTE REMARKS	MODELLO / DESCRIZIONE MODEL / DESCRIPTION
0186598 	101694 101694 113254	L= 120 M= 30x1,5 RHT	ASTRA BM
0196598 	101695 101695 113253	L= 120 M= 30x1,5 LHT	ASTRA BM
0186421 	10229 10229	L= 125 M= 38x1,5 RHT	ASTRA BM
0196421 	30042 30042	L= 125 M= 38x1,5 LHT	ASTRA BM
0186422 	101347 101347 113251	L= 135 M= 38x1,5 RHT	ASTRA BM 304-305 F
0196422 	101348 101348 113252	L= 135 M= 38x1,5 LHT	ASTRA BM 304-305 F



BARRE ACCOPPIAMENTO - TIE RODS

RIF. OCAP OCAP REF.	RIF. ORIG O.E. NUMBER	NOTE REMARKS	MODELLO / DESCRIZIONE MODEL / DESCRIPTION
0509930 	RAK1390 RAK1390	L=120 T=31	LEYLAND OLIMPIAN
0506167  0186167 M=28x1,5 RHT 0196167 M=28x1,5 LHT	HJK3892 HJK3892 1407963	L=1475	LF 45 FA - LF FA
0507942  0187843 M=30x1,5 RHT	1361155 1297572 1361155	L=1522 T=52	95 XF - CF 75 - CF 85 - XF 105 - XF 95
0509955  0187894 M=30x1,5 RHT	1732980 1732980	L=1522 T=52	CF 75 - CF 85 - XF 105
0506168  0186168 RHT M28x1,5 0196168 LHT M28x1,5	1407963 1407963	L=1640	45 LF
0509956  0186424 M=28x1,5 RHT 0196424 M=28x1,5 LHT	1351205 1351205	L=1646	
0509957  0186598 M=30x1,5 RHT 0196598 M=30x1,5 LHT	1732972 1732972	L=1646	
0509958  0186598 M=30x1,5 RHT	1286341		















BARRE ACCOPPIAMENTO - TIE RODS

RIF. OCAP OCAP REF.	RIF. ORIG O.E. NUMBER	NOTE REMARKS	MODELLO / DESCRIZIONE MODEL / DESCRIPTION
<p>0507800</p>  <p>0186598 M=30x1,5 RHT</p>	<p>1286342 1286342 0275962</p>	<p>L=1686</p>	<p>75 CF - 85 CF - F 75 - F 85 - F 95 - 75 XF - 85 XF - 95 XF</p>
<p>0507949</p>  <p>0186598 M=30x1,5 RHT 0196598 M=30x1,5 LHT</p>	<p>1700000 1700000</p>	<p>L=1690 T=40</p>	<p>CF 65 - CF 75 - CF 85 - XF 105</p>
<p>0506432</p>  <p>0186424 M=30x1,5 RHT</p>	<p>1286343 1286343 1353396</p>	<p>L=1698 T=52</p>	<p>75 CF - 85 CF - F 65 - F 75 - F 85 - F 95 - 75 XF - 85 XF - 95 XF - CF 75 - CF 85 - XF95 - XF 105</p>
<p>0507933</p>  <p>0186424 M=30x1,5 RHT 0196424 M=30x1,5 LHT</p>	<p>1270853 1270853 1353391</p>	<p>L=1698 T=40</p>	<p>95 XF - CF 65 - CF 75 - CF 85 - LF 55 - XF 95 - XF 105</p>
<p>0507931</p>  <p>0187843 M=30x1,5 RHT</p>	<p>1361157 1361157 1353400 1295415</p>	<p>L=1733 T=52</p>	<p>85 CF - F 2100</p>
<p>0507934</p>  <p>0186424 M=30x1,5 RHT 0196424 M=30x1,5 LHT</p>	<p>1337644 1337644 0288281 288281 1270854</p>	<p>L=1734 T=40</p>	<p>75 CF-FA - 85 CF-FA - 95 XF - CF 75-85 - LF 45-55 - XF 95-105</p>
<p>0509438</p>  <p>0187894 M=30x1,5 RHT</p>	<p>1732973 1732973</p>	<p>L=1698 T=52</p>	<p>CF 75 - 85 XF 105</p>
<p>0509469</p>  <p>0186598 M=30x1,5 RHT 0196598 M=30x1,5 LHT</p>	<p>1807596 1807596</p>	<p>L=1766 T=40</p>	<p>XF FA-FAD-FAR-FAS-FT-FTP-FTR-FTS</p>

















BARRE ACCOPPIAMENTO - TIE RODS

RIF. OCAP OCAP REF.	RIF. ORIG O.E. NUMBER	NOTE REMARKS	MODELLO / DESCRIZIONE MODEL / DESCRIPTION
<p>0509959</p>  <p>0186598 M=30x1,5 RHT </p> <p>0196598 M=30x1,5 LHT </p>	<p>1700001 1700001</p>	<p>L=1734 T=40</p>	









TIRANTI LONGITUDINALI - DRAG LINKS

RIF. OCAP OCAP REF.	RIF. ORIG O.E. NUMBER	NOTE REMARKS	MODELLO / DESCRIZIONE MODEL / DESCRIPTION
0509931   0186424 M=28x1,5 RHT	1351741 1351741	L=588	95XF FTG-XF95 FAK
0509932   0186598 M=30x1,5 RHT	1451119 1451119	L=590	FT-CF75-CF85-XF95-XF105
0509933 	0094006 0094006		F 95
0507939   0186424 M=30x1,5 RHT	1385488 1385488 1351730 0593883 1351745	L=622 T=42	75 CF - 85CF - 85 FT
0507930   0187723 M=30x1,5 RHT	1143319 1143319 1144018	L=708 T=42	
0507798   0186598 M=30x1,5 RHT	0890991 0890991	L=715	F 1700 - F 1900
0509934   0186598 M=30x1,5 RHT	0890992 0890992	L=715	
0507924   0186598 M30x1,5 RHT	0087932 S009593 0087932 389870	L=716 T=50	

















TIRANTI LONGITUDINALI - DRAG LINKS

RIF. OCAP OCAP REF.	RIF. ORIG O.E. NUMBER	NOTE REMARKS	MODELLO / DESCRIZIONE MODEL / DESCRIPTION
0506431   0186758 M=30x1,5 RHT	0094016 0094016 0171215	L=744	F 95 - F 2100-F 2300-F 2500-F 2700
0509935 	1321170 1321170	L=820	
0507944   0186424 M=30x1,5 RHT 0196424 M=30x1,5 LHT 	1385490 1385490 1351732 1257992	L=831 T=36	85 FAD
0506434   0186424 M=30x1,5 RHT	1283212 1283212 1247957 1385492	L=848 T=52	F 75 - 65 CF - 75 CF - 85 CF - 75 XF - CF 75 - CF 85
0507935   0186598 M=30x1,5 RHT	1602820 1363858 1602820 1448062	L=855	CF 65 - CF 75 - CF 85
0507784   0186424 M=30x1,5 RHT	1257991 1257991 1351718 1385493	L=860 T=36	75 CF - 85 CF-430 FAD
0507937   0186598 M=30x1,5 RHT 0196598 M=30x1,5 LHT 	1451118 1451118	L=860 T=38	CF 75 - CF 85 - XF 95
0507938   0186598 M=30x1,5 RHT	1451129 1451129 1380417	L=860 T=36	CF 75 - CF 85









TIRANTI LONGITUDINALI - DRAG LINKS

RIF. OCAP OCAP REF.	RIF. ORIG O.E. NUMBER	NOTE REMARKS	MODELLO / DESCRIZIONE MODEL / DESCRIPTION
<p>0509936</p>  <p>0186424 M=30x1,5 RHT</p>	<p>1277568 1277568</p>	<p>L=865 T=52</p>	<p>75 CF</p>
<p>0509937</p>  <p>0186424 M=30x1,5 RHT</p>	<p>1277567 1277567</p>	<p>L=865 T=52</p>	<p>85 CF</p>
<p>0507948</p>  <p>0186598 M=30x1,5 RHT</p>	<p>1602821 1602821 1448063 1363859</p>	<p>L=867 T=50</p>	<p>CF 65 - CF 75 - CF 85</p>
<p>0506429</p>  <p>0186758 M=30x1,5 RHT</p>	<p>0094029 0094029 0117343</p>	<p>L=872</p>	<p>F 95 - F 2300-F 2800 - F 3300-F 3600</p>
<p>0506435</p>  <p>0186424 M=30x1,5 RHT</p>	<p>1283211 1283211 1247956 1385497 1351714</p>	<p>L=876 T=52</p>	<p>CF 75 - CF 85 - F 75- F 85 - 65 CF - 75 CF - 85 CF 75 XF- 85 XF</p>
<p>0507943</p>  <p>0187943 M=30x1,5 RHT</p>	<p>1143322 1143322 1193034</p>	<p>L=882 T=52</p>	
<p>0509938</p>  <p>0197928 M=30x1,5 LHT</p>	<p>1406038 1406038</p>	<p>L=885</p>	
<p>0509939</p>  <p>0197928 M=30x1,5 LHT</p>	<p>1406600 1406600</p>	<p>L=900</p>	











TIRANTI LONGITUDINALI - DRAG LINKS

RIF. OCAP OCAP REF.	RIF. ORIG O.E. NUMBER	NOTE REMARKS	MODELLO / DESCRIZIONE MODEL / DESCRIPTION
<p>0507928</p>  <p>0197928 M=30x1,5 LHT </p>	<p>1700912 1405655 1406025 1700912 1407144 1401940</p>	<p>L=900 T=38</p>	<p>LF 45 FA</p>
<p>0509940</p>  <p>0196424 M=30x1,5 LHT </p>	<p>1405363 1405363</p>	<p>L=909 T=42</p>	<p>55 LF</p>
<p>0509941</p>  <p>0196424 M=30x1,5 LHT </p>	<p>1401937 1401937</p>	<p>L=910 T=40</p>	<p>LF 55 FA/FAN/FT</p>
<p>0509942</p> 	<p>1407393 1407393</p>	<p>L=925 T=42</p>	<p>LF 55 FA</p>
<p>0509943</p> 	<p>1405309 1405309</p>	<p>L=926 T=46</p>	<p>CF 65 FA - LF 65 FA</p>
<p>0509944</p>  <p>0196424 M=30x1,5 LHT </p>	<p>1401932 1401932</p>	<p>L=930 T=46</p>	<p>LF 55 FA</p>
<p>0509945</p>  <p>0186424 M=30x1,5 RHT </p>	<p>1283203 1283203</p>	<p>L=990 T=52</p>	<p>95 XF</p>
<p>0507947</p>  <p>0186598 M=30x1,5 RHT </p>	<p>1395994 1395994</p>	<p>L=991 T=50</p>	<p>XF 95 - XF 105</p>
<p>0506430</p>  <p>0186598 M=30x1,5 RHT </p>	<p>0094038 0094038 0554765 094038 554765 94038 525443</p>	<p>L=995 T=52</p>	<p>F 85 - F 95- XF 95 - 95 XF</p>









TIRANTI LONGITUDINALI - DRAG LINKS

RIF. OCAP OCAP REF.	RIF. ORIG O.E. NUMBER	NOTE REMARKS	MODELLO / DESCRIZIONE MODEL / DESCRIPTION
<p>0509946</p>  <p>0186598 M=30x1,5 RHT</p>	<p>1395993 1395993</p>	<p>L=996 T=38</p>	<p>XF 105-XF 95</p>
<p>0507492</p>  <p>0186598 M=30x1,5 RHT</p>	<p>0094037 0094037</p>	<p>L=998</p>	<p>85 CF</p>
<p>0507932</p>  <p>0186424 M=30x1,5 RHT</p>	<p>1385498 1385498 1311048 1351737</p>	<p>L=998 T=36</p>	<p>95 XF - XF 95</p>
<p>0507495</p>  <p>0186598 M=30x1,5 RHT</p>	<p>0098726 0098726</p>	<p>L=999</p>	
<p>0509947</p>  <p>0186598 M=30x1,5 RHT</p>	<p>1395995 1395995</p>	<p>L=1000 T=52</p>	
<p>0506433</p>  <p>0186424 M=30x1,5 RHT</p>	<p>1291060 1291060 1385499 1351734</p>	<p>L=1005 T=52</p>	<p>F 95- XF 95 - 75 CF - 85 CF - 95 XF U.S.</p>
<p>0509948</p>  <p>0186424 M=30x1,5 RHT</p>	<p>1291048 1291048</p>	<p>L=1008</p>	<p>95 XF FA/FAR/FAS</p>
<p>0507799</p>  <p>0186598 M=30x1,5 RH</p>	<p>0094613 0094613 94613 0362413</p>	<p>L=1008</p>	<p>F 95 - 95 XF</p>









TIRANTI LONGITUDINALI - DRAG LINKS

RIF. OCAP OCAP REF.	RIF. ORIG O.E. NUMBER	NOTE REMARKS	MODELLO / DESCRIZIONE MODEL / DESCRIPTION
0509949  0289927 M=24x1,5 RHT	1306332 1306332	L=1018	
0507945  0186598 M=30x1,5 RH	0094038 0094044 0274878 1152427	L=1130 T=40	
0507946  0186424 M=30x1,5 RHT	1191900 1143324 1191900	L=1197 T=40	
0509950  0289927 M=24x1,5 RHT	1269973 1269973	L=1328	
0507494  0186598 M=30x1,5 RHT	0094053 0094053	L=1544	
0507940  	1385506 1315530 1351731 1385506	L=1658 T=52	
0509390  	1408040 1408040	L=1691 T=50	
0509960  	1433448 1433448	L=1815 T=42	
0507941  	1346489 1346489 1351720 1385513	L=1818 T=42	
0509961  	1396000 1396000	L=1952 T=42	

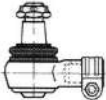





TIRANTI LONGITUDINALI - DRAG LINKS

RIF. OCAP OCAP REF.	RIF. ORIG O.E. NUMBER	NOTE REMARKS	MODELLO / DESCRIZIONE MODEL / DESCRIPTION
<p>0509985</p> 	<p>1395999 1395999</p>	<p>L=1952 T=42</p>	
<p>0507936</p> 	<p>1451122 1451122 1392640</p>	<p>L=1977 T=52</p>	<p>CF 75 - CF 85</p>
<p>0509459</p>  <p>0186598 M=30x1,5 RHT</p> 	<p>1902942 1902942 1828523</p>	<p>L=785 T=52</p>	<p>CF - XF</p>
<p>0509464</p>  <p>0186598 M=30x1,5 RHT</p> 	<p>1448064 1448064 1373878</p>	<p>L=865 T=52</p>	<p>CF 75 - 85</p>
<p>0509474</p>  <p>0186598 M=30x1,5 RHT</p> 	<p>1426101 1426101</p>	<p>L=1004 T=52</p>	<p>CF 85 XF 95-105</p>



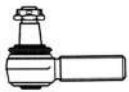
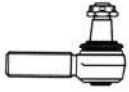

TESTE STERZO - TIE RODS END

RIF. OCAP OCAP REF.	RIF. ORIG O.E. NUMBER	NOTE REMARKS	MODELLO / DESCRIZIONE MODEL / DESCRIPTION
0289923 	1271126 1271126 42538048 82953016019 81953016268 82953016018 3099128 3090291	L=90 M=36x1,5 RHT	
0287503 	0273203 0273203 1399724	L=95 M=22x1,5 RHT	CF75-XF95-XF105
0186595 	0608530 0608530	L=95 M=24x1,5 RH	Serie 400 - 95 - 95 XF
0287291 	0817824 0817824	L=95 M=24x1,5 RHT	LF 55
0186613 	0607451 0607451 1373135 0607453 0110197 1228114 ACU9242	L=105 M=28x1,5 RHT	XF-F
0196613 	0607452 0607452 0110196 1373137 ACU9241	L=105 M=28x1,5 LHT	XF-F
0186608 	1689604 1689604 1923963		LF 45 FA
0196608 	1689605 1689605 1923962 8123326	L=115 M=28x1,5 RHT	LF 45 FA
0186424 	0586753 0586753 1320855 1229944 1342026 0607999 0694298 0694360 0698609 586753 698609 1326896 MAK1296	L=115 M=30x1,5 RHT	65/75/85 CF - 95 XF - CF 75/85 - F 65/75/85/95/1200/1300/1400/ - 1500/1600/1700/1900 - LF 55





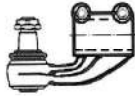
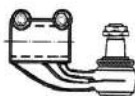
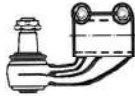
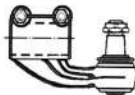
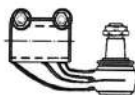
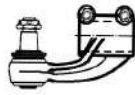
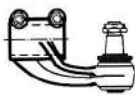

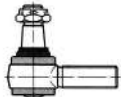

TESTE STERZO - TIE RODS END

RIF. OCAP OCAP REF.	RIF. ORIG O.E. NUMBER	NOTE REMARKS	MODELLO / DESCRIZIONE MODEL / DESCRIPTION
0196424 	1319838 1319838 0311300 0607998 1315447 1338714 MAK1295 1407394	L=115 M=30x1,5 LHT	CF 65 - CF 75 - CF 85 - 45 - F 1100 - F 1200-F 1300
0289927 	1344684 1344684	L=115 M=24X1,5 RHT	75CF-85CF-95XF-XF95
0189926 	1401944 1401944	L=120 M=30 x1,5 RHT	LF 45 FA
0187146 	0069867 0069867 0161376 0608000	L=120 M=30x1,5 RHT	F 1600FA/FGG/FT/FAV - F 1800
0187785 	NAK3395 NAK3395	L=120 M=30X1,5 RHT	LEYLAND DAF: - CONSTRUCTOR - (8x2, 8x4) (6x2, 6x4) - FA 50 (17&18 tons) - FA 60-FA 80 - FREIGHTER (15,16 & 17 tons) - LYNX OLYMPIAN - ROADRUNNER - ROADTRAIN T 45, TIGER
0197785 	NAK3394 NAK3394	L=120 M=30X1,5 LHT	LEYLAND DAF: - CONSTRUCTOR - (8x2, 8x4) (6x2, 6x4) - CF 75 - CF 85 - F 500 - F 600 - F800 - F 900 - FA 50 (17&18 tons) - FA 60-FA 80 - FREIGHTER (15,16 & 17 tons) - LYNXOLYMPIAN - ROADRUNNER - ROADTRAIN T 45, TIGER
0186598 	1257890 1257890 0607981 0698450 0696226 1603789 1149907 1152350 1618048	L=120 M=30x1,5 RHT	F1000 > F2300 - F500 > F900 - F2500 - F2700 - 65 - 75 - 85 CF - CF75 - 85 - F75 - 89 -95 - 95XF - XF 95 - XF 105
0196598 	1228115 1228115 0607053 1329134 0696225	L=120 M=30x1,5 LHT	F1000 > F2300 - F500 > F900 - F2500 - F2700 - 65 - 75 - 85 CF - CF75 - 85 - F75 - 89 -95 - 95XF - XF 95 - XF 105





TESTE STERZO - TIE RODS END

RIF. OCAP OCAP REF.	RIF. ORIG O.E. NUMBER	NOTE REMARKS	MODELLO / DESCRIZIONE MODEL / DESCRIPTION
0197928 	1401942 1401942 AFRA635	L=120 M=30x1,5 LHT	LF 45 FA
0289986 	1603788 1603788	L=120 M=24x1,5 RHT	
0286427 	0606923 0606923 606923	L=130 M=46x1,5 RH	95 XF - F 95/1600/1700/1900 - F 2000/2100/2105/2200 - F 2300/ 2305/2500/2505/2600 - F 2700/2800/2900 - F 3200/3300/3305/ 3600 - TT 2100
0296427 	0606922 0606922 606922	L=130 M=46x1,5 LHT	95 XF - F 95/1600/1700/1900 - F 2000/2100/2105/2200 - F 2300/ 2305/2500/2505/2600 - F 2700/2800/2900 - F 3200/3300/3305/ 3600 - TT 2100
0286428 	0067389 0067389 67389	L=130 M=48x1,5 RHT	65-75 (4x2) - 85 (4x2-6x2-6x4-8x2-8x4) - 95 (4x2-6x2-6x2 T.Unit Twinteer) - 65/75/85 CF - 95 XF - CF 65/75/85 - F 65/75/85/95 - FT 95
0296428 	0067303 0067303 67303	L=130 M=48x1,5 LHT	65-75 (4x2) - 85 (4x2-6x2-6x4-8x2-8x4) - 95 (4x2-6x2-6x2 T.Unit Twinteer) - 65/75/85 CF - 95 XF - CF 65/75/85 - F 65/75/85/95 - FT 95
0297796 	1205248 1205248	L=133 M=52x1,5 RHT	75- 85- 95 XF - 75 - 85 CF - F 75 - 85 - 95
0287724 	1235514 1235514	L=133 M=52x1,5 RHT	75- 85- 95 XF - 75/85 CF - F 75/85/95
0297724 	1235515 1235515	L=133 M=52x1,5 LHT	75- 85- 95 XF - 75/85 CF - F 75/85/95
0186167 	- -	L=135 M=28x1,5 RHT	
0196167 	- -	L=135 M=28x1,5 LHT	





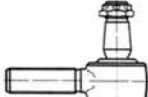
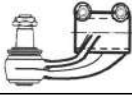
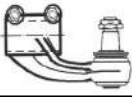

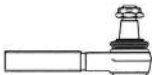

TESTE STERZO - TIE RODS END

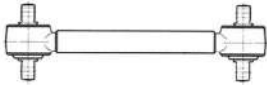
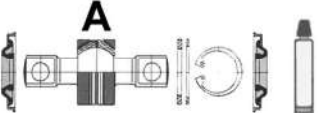
RIF. OCAP OCAP REF.	RIF. ORIG O.E. NUMBER	NOTE REMARKS	MODELLO / DESCRIZIONE MODEL / DESCRIPTION
0186758 	0609643 0609643 0122810 0586714 0607073 0609634 0696226	L=135 M=30x1,5 RHT	F 95/1600 - F 2000/2100/2200/2300/2500/2700/2800 - F 3300/ 3600
0187463 	0697221 0697221	L=135 M=38x1,5 RHT	
0187783 	1320855 1320855	L=140 M=30x1,5 RHT	
0188994 	1685552 1685552	L=140 M=30x1,5 RHT	
0199928 	1310760 1310760 1603418	L=141 M=30x1,5 LHT	85 - 85CF
0187843 	1389190 1389190	L=141 M=30x1,5 RHT	85CF - CF75 - CF95 - 95XF - XF95 - XF105
0187894 	1785340 1785340	L=145 M=30x1,5 RHT	CF75 - CF85 - XF105
0186168 	1604248 1604248 1705907 1902997 1703472	L=148 M=28x1,5 RHT	LF 45 FA
0196168 	1604247 1703473 1705908 1902996 1604247	L=148 M=28x1,5 LHT	LF 45 FA
0187723 	1603883 1603883	L=150 M=30x1,5 RHT	LF 55
0187530 	0698586 0698586	L=150 M=38x1,5 RHT	



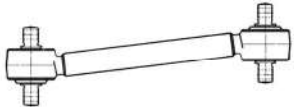

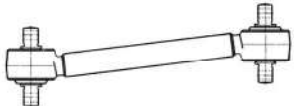

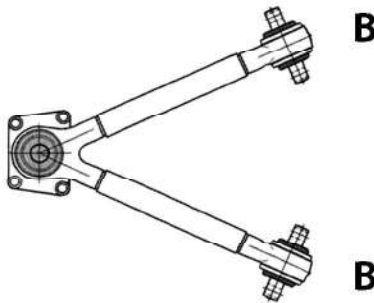
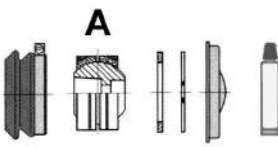

TESTE STERZO - TIE RODS END

RIF. OCAP OCAP REF.	RIF. ORIG O.E. NUMBER	NOTE REMARKS	MODELLO / DESCRIZIONE MODEL / DESCRIPTION
0289929 	PAX1459 6K13312 EAX1458 PAX1459	L=155 M=W1*11/16x12 RHT	BMC: FATIH-BISON-BUFFALO-CLYDESDALE-CRUISER - CONSTRUCTOR-REIVER-BOZER - BX1425/1600-MASTIFF- ROADTRAIN
0299929 	PAX1458 PAX1458 6K13313 EAX1459	L=155 M=W1*11/16x12 LHT	BMC: FATIH-BISON-BUFFALO-CLYDESDALE-CRUISER - CONSTRUCTOR-REIVER-BOZER - BX1425/1600-MASTIFF- ROADTRAIN
0197523 	0638680 0638680	L=160 M=38x1,5 LHT	
0287519 	0608122 0608122 608122	L=174 M=45x1,5 RHT	F1700/1900/2000/2100/2200/ - 2300/2500/2700/2800 - TT 2100
0297519 	0608123 0608123 608123	L=174 M=45x1,5 LHT	F1700/1900/2000/2100/2200/ - 2300/2500/2700/2800 - TT 2100
0187803 	ACU9240 ACU9240 AFRA888	L=180 M=28x1,5 RHT	45: - FA 45.120/45.130/150/160/180/210 - FA 1900
0197803 	ACU9239 ACU9239	L=180 M=28x1,5 LHT	45: - FA 45.120/45.130/150/160/180/210 - FA 1900



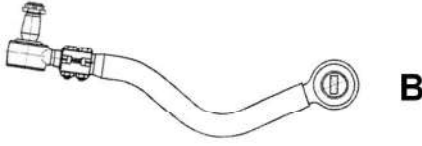



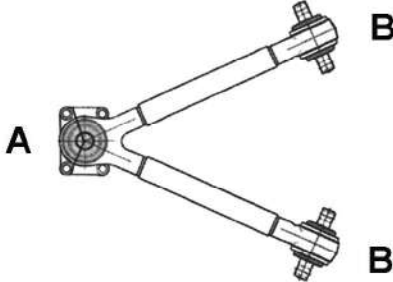

BARRE DI REAZIONE - TORQUE RODS

RIF. OCAP OCAP REF.	RIF. ORIG O.E. NUMBER	NOTE REMARKS	MODELLO / DESCRIZIONE MODEL / DESCRIPTION
0807555  A B	1261101 1261101	L=390 T=50 d1=21 - d2=19	SERIE 95 - 75 CF - 95 XF - CF 85 - F 95 - XF 95 - XF 105
0907556  A	0693778 0693778	l=152 p=24 D=65 d=21	
0907586  A	0005861533 0005861533	D=65	senza perno (without pin)
0907258  B	1271124 1271124 2980884 81432206132 81432206108	l=130 p=30 D=65 d=19	
0907757  B	- -	D=65	senza perno (without pin)
0807797  A A	1284860 1284860 0655695 0655697 0646373 1620438	L=600 d=21	FT - FTG - FTR - FTS - FTT - XT - XF FT - XF FTG - XF FTR - XF FTS - XF TT - F2800 - F3300
0907359  A	0691709 0691709 0513757	l=130 p=30 D=70 d=21	
0807501  A A	0267743 0267743 1361650	L=605 T=48 d=21	65/75/85/95 CF - 95 XF - CF 380 1999 >.... - F 65/75/85/95 - XF 95
0907359  A	0691709 0691709 0513757	l=130 p=30 D=70 d=21	
0807927  A A	1294251 1294251	L=606	75CF-85FTG-CF75-CF85



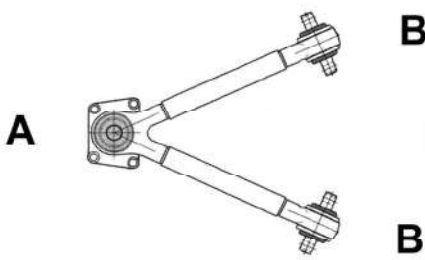

BARRE DI REAZIONE - TORQUE RODS

RIF. OCAP OCAP REF.	RIF. ORIG O.E. NUMBER	NOTE REMARKS	MODELLO / DESCRIZIONE MODEL / DESCRIPTION
0907927 A 	1321936 1321936	p=24 D=67 d=19	
0807489 A  B	0080521 0080521 16170096 1368270 1361651 1390932	L=608 T=48 d=23	CF - FT - FTG - FTT - FTS - FTR - XF - CF
0907487 A 	0069600 0069600 0691704	IK=38 D=65	
0907489 B 	0698724 0698724	L=152 d=23 p=24 D=70	-
0807507 A  A	0296110 0296110 296110 X50561	L=680 d=19	
0907259 A 	0689749 0689749	l=130 p=30 D=70 d=19	
0807513 A  B  0187530 M=38x1,5 RHT	0392418 0392418	L=862 d=19	MBG 200/230 - SB 230/270/300/2300/2700/3000 - SR 300/301
0907508 A 	1208073 1208073	D=55 K=38	
0907327 B 	0067354 0067354	l=130 p=24 D=62 d=19	









BARRE DI REAZIONE - TORQUE RODS

RIF. OCAP OCAP REF.	RIF. ORIG O.E. NUMBER	NOTE REMARKS	MODELLO / DESCRIZIONE MODEL / DESCRIPTION
0807528 	0658102 0658102	L=870 d=17	75/85 CF - 95 XF - CF 75/85 - XF 95
0907531 	0689747 0689747	D=70 K=45	
0907528 	0689748 0689748	l=115 p=24 D=62 d=17	
0807509  0187530 M=38x1,5 RHT	0368541 0368541	L=880 d=19	75/85 CF - F 17/19/21/23/25/75/85/95 - TT 2100
0907508 	1208073 1208073	D=55 K=38	
0907327 	0067354 0067354	l=130 p=24 D=62 d=19	
0807525 	0649819 0649819	L1=550 T=58 d=23 L2=550	F 2100-2300-2500-2700-2800-3300 - CF 75 - 85 - F 95 - 95 XF - XF 95 - XF 105
0907525 	0696320 0696320	L=61 IK=56 D=80	







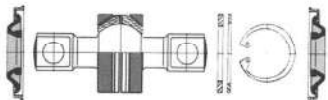

BARRE DI REAZIONE - TORQUE RODS

RIF. OCAP OCAP REF.	RIF. ORIG O.E. NUMBER	NOTE REMARKS	MODELLO / DESCRIZIONE MODEL / DESCRIPTION
0907529 	0696321 0696321	l=152 p=35 D=80 d=23	
0807930 	1793876 1793876 1620436 1361652	L=608,2 T=48 d=23	75 CF - CF 75 - CF 85
0907525 	0696320 0696320	L=61 IK=56 D=80	
0907489 	0698724 0698724	L=152 d=23 p=24 D=70	

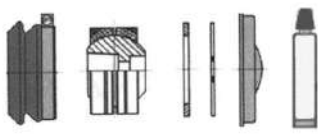

KIT DI SOSPENSIONE - SUSPENSION KITS

RIF. OCAP OCAP REF.	RIF. ORIG O.E. NUMBER	NOTE REMARKS	MODELLO / DESCRIZIONE MODEL / DESCRIPTION
0907525 	0696320 0696320	L=61 IK=56 D=80	95 F 2100-2300-2500-2700 - 75CF-CF75-CF85
0907489 	0698724 0698724	L=152 d=23 p=24 D=70	75 CF - CF 75 - CF 85
0907508 	1208073 1208073	D=55 K=38	MBG 200/230 - SB 230/270/300/2300/2700/3000 - SR 300/30175/ 85 CF - F17/19/21/23/25/75/85/95 - TT2100
0907327 	0067354 0067354	l=130 p=24 D=62 d=19	MBG 200/230 - SB 230/270/300/2300/2700/3000 - SR 300/30175/ 85 CF - F17/19/21/23/25/75/85/95 - TT2100
0907528 	0689748 0689748	l=115 p=24 D=62 d=17	75 - 85 CF - CF 75 - 85 - 95 XF - XF 95
0907925 	1445656 1445656		65 CF-75 CF-CF 65-CF 75-CF 85-LF 45-LF 55
0907926 	1398368 1398368		65 CF-75 CF-85 CF-85 FT-95 FA-95 FT - 95 XF-CF 85-F 2300-LF 45
0907927 	1321936 1321936	p=24 D=67 d=19	75 CF-75 FA-85 CF-85 FA-85 FT
0907997 	1243618 1243618	l=115 p=24 D=67 d=17	CF 75-85 - XF 95-105
0907556 	0693778 0693778	l=152 p=24 D=65 d=21	95 FA/FAD/FAG/FAK/FAR - /FAT/FT/FTG/FTT - 95 XF FA/FAC/ FAD/FAR/FAS - /FAT/FT/FTG/FTR/FTS/FTT - F 2800- F 3300

KIT DI SOSPENSIONE - SUSPENSION KITS

RIF. OCAP OCAP REF.	RIF. ORIG O.E. NUMBER	NOTE REMARKS	MODELLO / DESCRIZIONE MODEL / DESCRIPTION
0907531 	0689747 0689747	D=70 K=45	
0907259 	0689749 0689749	l=130 p=30 D=70 d=19	
0907359 	0691709 0691709 0513757	l=130 p=30 D=70 d=21	FT - FTG - FTR - FTS - FTT - XT - XF FT - XF FTG - XF FTR - XF FTS - XF TT - F2800 - F3300 - 65/75/85 CF - 95 XF - CF 65/75/85 F 95 - XF 95
0907296 	1252284 1252284	l=130 p=24 D=62 d=21	85 CF - F 2100 FA/FAS/FT
0907529 	0696321 0696321	l=152 p=35 D=80 d=23	65-75-85-95 - F2000-2100-2200-2300-2500 - 2600-2700-2800- 2900-3200 - 3300-3600
0907257 	0691704 0691704	L=50 IK=38 D=65	75 - 85 CF - F75 - 85 - 95 - 95XF - F1900 - 2300 - 2700
0907297 	1376730 1376730	IK=38 D=65	65 - 75 - 85 CF - 95XF - F2700
0907304 	691703 0691703	l=152 p=24 D=70 d=21	F2100 - F2300 - F2500 - F2800 - F2900 - F3200 - F3300 - F3600
0907686 	696321 696321 0696321	l=152 p=24 D=80 d=23	F2100 - F2300 - F2500 - F2800 - F2900 - F3200 - F3300 - F3600 - 65 - 75 - 85 CF - F75- 85 - 95 - 95XF
0907931 	1376728 1376728		



KIT DI SOSPENSIONE - *SUSPENSION KITS*

RIF. OCAP OCAP REF.	RIF. ORIG O.E. NUMBER	NOTE REMARKS	MODELLO / DESCRIZIONE MODEL / DESCRIPTION
0907932 	1376729 1376729		
0909447 	1676776 1676776	D=108	CF 75-85 LF 55 XF 95 - 105







STABILIZZATORI - STABILIZERS

RIF. OCAP OCAP REF.	RIF. ORIG O.E. NUMBER	NOTE REMARKS	MODELLO / DESCRIZIONE MODEL / DESCRIPTION
<p>0509987</p> 	<p>1392962 1392962</p>	<p>L=2028</p>	

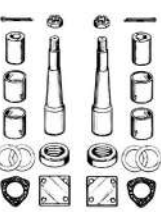

TESTE COMANDO CAMBIO - GEAR BOX CONTROL BALL JOINTS

RIF. OCAP OCAP REF.	RIF. ORIG O.E. NUMBER	NOTE REMARKS	MODELLO / DESCRIZIONE MODEL / DESCRIPTION
0287229 	1249129 589333 656085 1249129	L=55 M=12x1,75 RH	65/75/85 CF - 95 XF - F
0297229 	1249088 1249088 0592106 0656084	L=55 M=12x1,75 LH	65/75/85 CF - 95 XF - F
0187228 	386930 386930 0386930	L=85 M=14 x 1,5 RH	95 XF - F





KIT PERNO FUSO - KING PIN SET

RIF. OCAP OCAP REF.	RIF. ORIG O.E. NUMBER	NOTE REMARKS	MODELLO / DESCRIZIONE MODEL / DESCRIPTION
0927398 	0206137 0206137 206137	L=247 D=33/41	1958 > 71 - F2900-F2000-F2003 - 1958 > 71 - A2004 - 1963 > 71 - AE2300-AE2600 - 1968 >71 - F1600-FA2500-FT2500-FA2000- FT2000 - 1975 > - F2100-F2105 - 1978 > - SB2000-SB2005
0927399 	0100873 0100873 100873	L=245 D=30/41	1971 > - FA1400-FT1400 - 1968 > - FA1600-FT1600-FAS1600 - 1975 > - F1300-F1500
0927400 	0548588 0548588 548588	L=265 D=31/41	1958 > 71 - 1900-2000-2003-A2004 - 1963 > 71 - AE2300-AE2600 - 1968 > - FAT/FM/FAS2000 - FM/FAS/FAT2005 - 1968 > - FA/FT/ FAS/FAT2200 - 1968 > - FA/FT/FAS/FAT2205 - 1968 >1974 - FT2600 - 1968 > 1974 - FA/FT/FAS/FAT/FTT2605 - 1974 > - AT2400/ATE2400/FAZ2205 - 1975 > - F2800/F2805 - MB200
0927401 	0118086 0118086 118086	L=275 D=31,5/50	1974 > - FA/FAS/FAT/FFT/FAR/FTS/FT2800 - 1974 > - N2800 - 1974 > - FA/FAS/FAT/FTT/FAR/FT2805 - 1975 > - F/FAS/FAT/ FM200 - 1975 > - F/FAS/FAT/FM2005 - 1975 > - F2100-F2105- F2200-F2205-F2300-F2305 - 1975 > - MB200 - F3300 - F3305
0927402 	0681621 0681621 681621 0680374 680374	L=270 D=31,5/50	1980 > - F1600-F2100-F2105-F2300-F2305 - 1980 > - F2500- F2505-F2800-F3300-F3305 - 1980 > - SB2300-SB2305-SB3000 - F2800-F2805-MBG - 1981 > - MB200-MB230-SB201-SB210 - 1986 > - TB2100-F3600-N3300
0927403 	0681706 0681706 681706	L=270 D=31,5/50	65/75/85 CF - 95 XF - XF 95
0927404 	0681511 0681511 681511	L=265 D=31,5/45	85 CF - 1986 > F 95/1100/1300/1700/1900



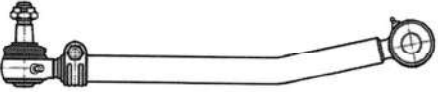

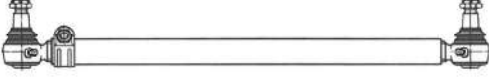
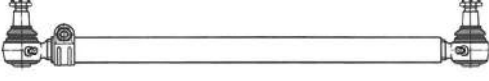
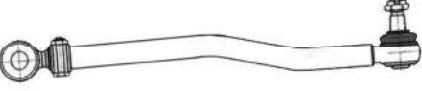
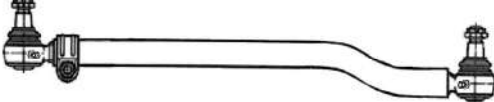

SILENTBLOC - BUSHING

RIF. OCAP OCAP REF.	RIF. ORIG O.E. NUMBER	NOTE REMARKS	MODELLO / DESCRIZIONE MODEL / DESCRIPTION
1216312 	0366351 0366351		
1216313 	0371586 0371586		
1216314 	0281007 0281007		

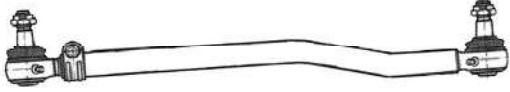
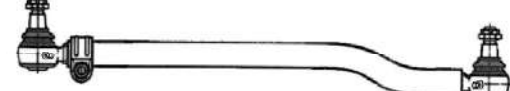
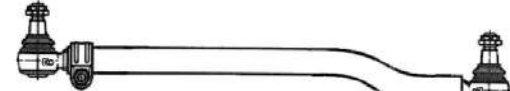





TIRANTI LONGITUDINALI - DRAG LINKS

RIF. OCAP OCAP REF.	RIF. ORIG O.E. NUMBER	NOTE REMARKS	MODELLO / DESCRIZIONE MODEL / DESCRIPTION
0506712  0186605 M=38x1,5 RHT	4520694 4520694 4669091	L=517	180NC/NT/NTS - 690N1//N2/N3/N4/T2 - 691N/T/TS
0506733  0196603 M=25x1,5 LHT	8526148 8526148 8558647	L=630	OM: - LEONCINO - LUPETTO - CERBIATTO
0506991  0186603 M=25x1,5 RHT	8535664 8535664 8558651	L=630	OM: - LUPETTO 2?
0506753 	4520698 4520698 4669094	L=630	180NC/NT/NTS - 690N1//N2/N3/N4/T2 - 691N/T/TS
0506993  0186603 M=25x1,5 RHT	8525704 8525704	L=630	OM: - TIGROTTO M3
0507171  0186603 M=25x1,5 RHT	8533963 8533963	L=665	OM: - DAINO - TIGROTTO MA - TIGROTTO 50-55Q.li
0506977  0196603 M=25x1,5 LHT	4568702 4568702	L=705	650 E - 662 N
0506976  0196603 M=25x1,5 LHT	4588688 4588688	L=707	645N1 - 650N1 - 662N1



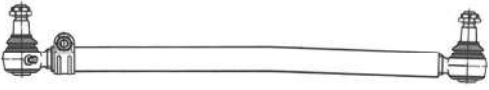
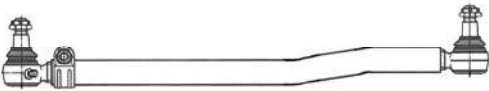
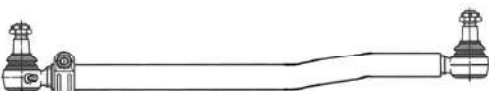





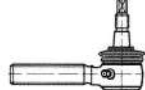

TIRANTI LONGITUDINALI - DRAG LINKS

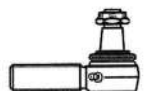
RIF. OCAP OCAP REF.	RIF. ORIG O.E. NUMBER	NOTE REMARKS	MODELLO / DESCRIZIONE MODEL / DESCRIPTION
<p>0506711</p>  <p>0186604 M=28x1,5 RHT</p>	<p>4665501 4665501</p>	<p>L=782</p>	<p>673N/T - 130NC/NR/NT - veicolo a cabina fissa - (vehicle with fixed compartment)</p>
<p>0506710</p>  <p>0196603 M=25x1,5 LHT</p>	<p>4665209 4665209</p>	<p>L=798</p>	<p>100NC-110NC - 662N3/T-672N - veicoli con servosterzo - (vehicles with power steering)</p>
<p>0506714</p>  <p>0186604 M=28x1,5 RHT</p>	<p>4692686 4692686</p>	<p>L=825</p>	<p>110NC v.837TILT.CAB - 130NC</p>
<p>0506709</p>  <p>0196603 M=25x1,5 LHT</p>	<p>4665085 4665085 4626917</p>	<p>Lt=775</p>	<p>100NC-110NC e deriv. - 645N2/N3 - 650N2/N3 - 655N/N1 - 662N2/N3/T-672N</p>
<p>0507153</p>  <p>0186604 M=28x1,5 RHT</p>	<p>8558653 8558653</p>	<p>Lt=775</p>	<p>OM 120</p>
<p>0506738</p>  <p>0186603 M=25x1,5 RHT</p>	<p>8788387 8788387</p>	<p>Lt=825</p>	<p>100.13-100.F13 - 100EC-OMN100/10</p>
<p>0507154</p>  <p>0186604 M=28x1,5 RHT</p>	<p>4546822 4546822 4573092</p>	<p>L=883</p>	<p>643N/N1</p>
<p>0506740</p>  <p>0196603 M=25x1,5 LHT</p>	<p>8788641 8788641</p>	<p>L=885</p>	<p>100F13 - OM 120-OMN 100</p>

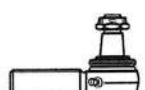





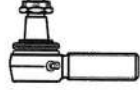

TIRANTI LONGITUDINALI - DRAG LINKS

RIF. OCAP OCAP REF.	RIF. ORIG O.E. NUMBER	NOTE REMARKS	MODELLO / DESCRIZIONE MODEL / DESCRIPTION
0506981  0186605 M=38x1,5 RHT	4574457 4574457	Lt=845	683N-619N
0506987  0186605 M=38x1,5 RHT	4545422 4545422	Lt=855	693N1/T1
0506750  0186605 M=38x1,5 RHT	4666991 4666991 4733704	L=906	160NC/R - 684N/NP/T/TP - OM 160/T
0506723  0186605 M=38x1,5 RHT	4666933 4666933 4733752 4666993	L=906	160NC/R - 684N/NP/T/TP
0506720  0186605 M=38x1,5 RHT	4624032 4624032 4732546 4666954	L=915	300PC/PT - 619NI/NIP/TI/TIP - 697N/NP/T/TP
0506721  0186605 M=38x1,5 RHT	4667156 4667156 4732549 4624116	Lt=855	300PC/PT - 619NI/NIP/TI/TIP - 697N/NP/T/TP
0507155  0186605 M=38x1,5 RHT	7136367 7136367	Lt=860	150N
0506971 	4668258 4668258		180NC/NT/NTS - 691N/T/TS
0506984 	4520744 4520744 4668402	L=865	690N1/N2/N3/N4

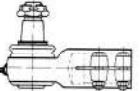
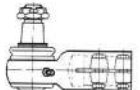
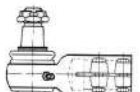

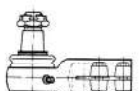
TESTE STERZO - TIE RODS END

RIF. OCAP OCAP REF.	RIF. ORIG O.E. NUMBER	NOTE REMARKS	MODELLO / DESCRIZIONE MODEL / DESCRIPTION
0286659 	4536229 4536229 4668368	L=82 m=24x1,5	180NC/NT/NTS - 690N1/N2/N3/N4 - 691N/T/TS - - Servosterzo - (Power steering)
0186601 	814304 814304	L=83 M=16x1 RHT	616 N1/N2/N3/N4 - OM 616
0196601 	814305 814305	L=83 M=16x1 LHT	616 N1/N2/N3/N4 - OM 616
0186603 	4018036 4018036 4663787	L=115 M=25x1,5 RHT	100.13/F13-100.14 - 110NC-100EC-100NC-314/3 - OMN 100/10 - LUPETTO-LEONCINO - CERBIATTO-DAINO - TIGROTTO
0196603 	4018037 4018037 4663791	L=115 M=25x1,5 LHT	100.13/F13-100.14 - 110NC-100EC-100NC-314/3 - OMN 100/10 - LUPETTO-LEONCINO - CERBIATTO-DAINO - TIGROTTO
0186604 	4028250 4028250 4663972	L=117 M=28x1,5 RHT	110 NC var 837 - TILT 643N/N1 - 673N-130NC - 130NR-130NT
0196604 	4028251 4028251 4663974	L=117 M=28x1,5 LHT	110 NC var 837 - TILT 643N/N1 - 673N-130NC - 130NR-130N
0186653 	4664343 4664343 4544893	L=118 M=64x1,5 RHT	160NC/NT-300PC - 619N1/N1P-697N/NP - 684N/NP/T/TP - - Servosterzo - (Power steering)
0186651 	4664345 4664345 4562450	L=118 M=64x1,5 RHT	160NC/NT-300PC - 619N1/N1P-697N/NP - 684N/NP/T/TP - - Servosterzo - (Power steering)
0186649 	4665005 4665005	L=120 M=64x1,5 RHT	100 F13/-NC-110NC-130NC/NR/NT - 645N/N1-650E-650N/N1/N2/ N3 - 655N/N1-662N/N2/N3-673N - - Servosterzo - (Power steering)
0186648 	4665007 4665007	L=120 M=64x1,5 RHT	100 F13/-NC-110NC-130NC/NR/NT - 645N/N1-650E-650N/N1/N2/ N3 - 655N/N1-662N/N2/N3-673N - - Servosterzo - (Power steering)
0186605 	4664297 4664297 4510019 4664292 4510620	L=130 M=38x1,5 RHT	180NC/NT/NTS - 682N2/N3/N4 - 682T2/T3/T4 - 683/619N - 690N1/ N2/N3/N4 - 691N/T/TS-693N/N1







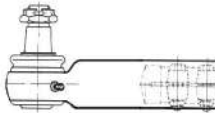

TESTE STERZO - TIE RODS END

RIF. OCAP OCAP REF.	RIF. ORIG O.E. NUMBER	NOTE REMARKS	MODELLO / DESCRIZIONE MODEL / DESCRIPTION
0196605 	4523292 4523292 4664295	L=130 M=38x1,5 LHT	682N2/N3/N4 - 682T2/T3/T4-683N - 619N-693N/N1
0186657 	4520697 4520697 4664586	L=130 M=38x1,5 RHT	180NC-180NT-180NTS - 690N1/N2/N3/N4-691N1/TS
0186684 	4580778 4580778	L=130 M=38x1,5 RHT	682N2/N3/N4 - 682T2/T3/T4 - - Servosterzo - (Power steering)
0286647 	4665009 4665009	L=130 M=30x1,5 RHT	100 F13/-NC-110NC-130NC/NR/NT - 645N/N1-650E-650N/N1/N2/ N3 - 655N/N1-662N/N2/N3-673N - - Servosterzo - (Power steering)
0287150 	4664090 4664090	L=130 M=30x1,5 RHT	643N/N1 - Servosterzo - (Power Steering)
0287151 	4664092 4664092 4664088	L=130 M=30x1,5 RHT	643N/N1 - - Servosterzo - (Power steering)
0187152 	4580782 4580782	L=130 M=38x1,5 RHT	682N2/N3/N4 - 682T2/T3/T4 - - Servosterzo - (Power steering)
0286652 	4582159 4582159 4664462	L=138 M=30x1,5 RHT	160NC/NT/-300PC/PT - 619N1/N1P-697NP-684N/NP/T/TP - - Servosterzo - (Power steering)
0286650 	4514245 4514245 4664460	L=138 M=30x1,5 RHT	160NC/NT-300PC - 684AN/NP/T/TP-690N1/N2/N3/N4 - 619N1/ N1P-697N/NP - TESTA ANT.LHD - TIEROD END FRONT LHD - Servosterzo - (Power steering)
0286665 	4025438 4025438	L=138 M=30x1,5 RHT	682N2/N3/N4 - 682T2/T3/T4 - - Servosterzo - (Power Steering)
0286666 	4533777 4533777	L=138 M=30x1,5 RHT	682N2/N3/N4 - 682T2/T3/T4 - - Servosterzo - (Power Steering)
0286606 	4510017 4510017 4664349	L=175 M=45x1,5 RHT	180NC/NT/NTS - 682N2/N3/N4 - 682T2/T3/T4 - 690N1/N2/N3/N4 - 691N/TS













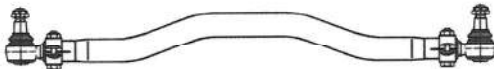





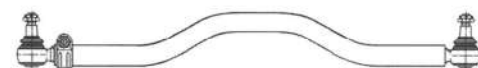



TESTE STERZO - TIE RODS END

RIF. OCAP OCAP REF.	RIF. ORIG O.E. NUMBER	NOTE REMARKS	MODELLO / DESCRIZIONE MODEL / DESCRIPTION
0296606 	4510018 4510018 4664347	L=175 M=45x1,5 LHT	180NC/NT/NTS - 682N2/N3/N4 - 682T2/T3/T4 - 690N1/N2/N3/N4 - 691N/TS
0286610 	4664353 4664353 4732041 4514235	L=190 M=52x1,5 RHT	160NC/NT/R - 300PC/PT - 619NI/NIP/TI/TIP - 684N/NP/T/TP - 697N/NP/T/TP
0296610 	4664351 4664351 4732042 4514236	L=190 M=52x1,5 LHT	160NC/NT/R - 300PC/PT - 619NI/NIP/TI/TIP - 684N/NP/T/TP - 697N/NP/T/TP
0286658 	4665422 4665422 4668206	L=200 M=30x1,5 RHT	180NC/NT/NTS - 691N/T-691TS - - Servosterzo - (Power Steering)











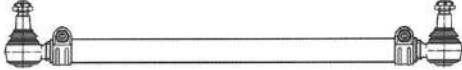

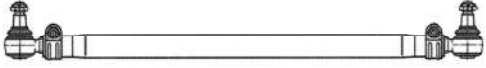





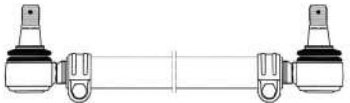

BARRE ACCOPPIAMENTO - TIE RODS

RIF. OCAP OCAP REF.	RIF. ORIG O.E. NUMBER	NOTE REMARKS	MODELLO / DESCRIZIONE MODEL / DESCRIPTION
0506613  0186613 M=28x1,5 RHT 0196613 M=28x1,5 LHT	60103171 60103171	L=1346	90-17WM - 75-13 AWM
0507290  0186613 M=28x1,5 RHT 0196613 M=28x1,5 LHT	8582320 8582320 8564386	L=1348	ZETA: - 50-9H/V - 60.11/V 65.9 - 65.12/H/V - 79.12/H/V - 79.14/H/V A 60.9
0506904  0186613 M=28x1,5 RHT 0196613 M=28x1,5 LHT	86012923 86012923 42037386 7166166	L=1404	80.13 - 80.16 - 90.13
0507323  0186595 M=24x1,5 RHT 0196595 M=24x1,5 LHT	86012924 86012924	L=1424	MK: - 75-9A/H - 80-9A/AH
0506542  0186608 M=28x1,5 RHT 0196608 M=28x1,5 LHT	7166384 7166384	L=1455	115.14/.17 - 135.14/.17 - 145.17
0506955  0186598 M=30x1,5 RHT	42118693 42118693 42117267 42118781	L=1458	EUROCARGO: - 95E15/E21 - 135E18/E23 - TECTOR: - 150E24 - EUROFIRE TECTOR: - 140E28
0507366  0186598 M=30x1,5 RHT 0196598 M=30x1,5 LHT	41033237 41032608 41033237	L=1477 T=48	EUROSTAR LD 240 - EUROTECH MP 240 - STRALIS AD 260-AS 260
0506950  0186424 M=30x1,5 RHT 0196424 M=30x1,5 LHT	98402553 98402553 500307556	L=1490	EUROCARGO - TECTOR - TECTOR RESTYLING







BARRE ACCOPPIAMENTO - TIE RODS

RIF. OCAP OCAP REF.	RIF. ORIG O.E. NUMBER	NOTE REMARKS	MODELLO / DESCRIZIONE MODEL / DESCRIPTION
0506827   0186424 M=30x1,5 RHT  0196424 M=30x1,5 LHT	86011651 86011651 42037384 86018015 42064639	L=1506	110-13A/AH - 110-16A/AH/AT - 130-13A/AH - 130-16A/AH - 130M11FL
0506818   0186598 M=30x1,5 RHT  0196598 M=30x1,5 LHT	42100262 42100262 2478910 42037040 42037041 42100263 42100703	L=1524 T=60	170.23 AHW - 160.23/60 AHW - 170 - 190.25AN - 190.26 260.25/34 - 300.26/30/36
0507312   0186598 M=30x1,5 RHT  0186598 M=30x1,5 RHT	42102633 42102633	L=1524	190-30H - 260-34AH - 330-30AN/H/N
0507302   0186613 M=28x1,5 RHT	42037032 42037032 42037033	L=1535	80-16 AW - 120-13/16/17 ANW
0506881   0186612 M=24x1,5 RHT  0196612 M=24x1,5 LHT	2443499 2443499	L=1544	256 M 19 FK
0506553   0186598 M=30x1,5 RHT  0196598 M=30x1,5 LHT	4835068 4835068	L=1565	160.26-170NC35 - 170/190/F26/F35/F35H - 180.24/.26-190.126/135 - 190.30/.38-190.33/.36/.42.48 - 220.36PT/.38PT - 240.26/.30P/.36/.38P/.48 - 260.36/.38/.48
0506953   0186424 M=30x1,5 RHT  0196424 M=30x1,5 LHT	4854871 4854871	L=1584	EUROCARGO - EUROFIRE - EUROFIRE TECTOR - MIDIRIDER - TECTOR - TECTOR RESTYLING
0506994   0186598 M=30x1,5 RHT  0196598 M=30x1,5 LHT	98470968 98470968 4844041	L=1590	EUROCARGO: - 170E15/E18/E23/E27 - 260E27KE - TECTOR: - 180E21/E24/E28 - EUROPOLIS: - 200E.9.15-200E.10.2

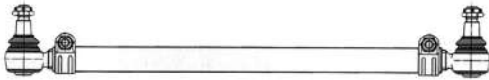





BARRE ACCOPPIAMENTO - TIE RODS

RIF. OCAP OCAP REF.	RIF. ORIG O.E. NUMBER	NOTE REMARKS	MODELLO / DESCRIZIONE MODEL / DESCRIPTION
0506788   0186424 M=30x1,5 RHT  0196424 M=30x1,5 LHT	42026853 42026853 2476050	L=1603	130-13 AH - 130-16 AH - 150-16 AN
0506794   0186598 M=30x1,5 RHT  0196598 M=30x1,5 LHT	42037655 42037655 2475843 42014656 42014657 42026837 42026840 42037657	L=1606	190-30 H - 240-34 AH - 260-25 AH - 260-25 AHB - 330-30 H
0506755   0186613 M=28x1,5 RHT  0196613 M=28x1,5 LHT	42102058 42102058 2476066	L=1630	160-23 AH - 190-30 HT
0506817   0186598 M=30x1,5 RHT  0196598 M=30x1,5 LHT	98458724 98458724 98427667	L=1636	EUROTECH: - 180E24/27/30 - 190E24/27/30 - 400E30/34
0506847   0186598 M=30x1,5 RHT  0196598 M=30x1,5 LHT	42003432 42003432	L=1640	190-26H/26N - 260-26H/26N/35H - 330F26/F35 - 330-26H/26N/30H/35H - TURBOSTAR - TURBOTECH
0506932   0186598 M=30x1,5 RHT  0196598 M=30x1,5 LHT	41005450 41005450 8163773 41005451 41036944 8138182	L=1641	EUROMOVER - EUROSTAR - EUROSTAR CURSOR - EUROTECH - EUROTECH CURSOR - EUROTRAKKER - EUROTRAKKER CURSOR - STRALIS
0507860   0186598 M=30x1,5 RHT  0196598 M=30x1,5 LHT	8137594 8137594	L=1385	EUROSTAR - EUROSTAR CURSOR - STRALIS - EUROTECH - EUROTECH CURSOR

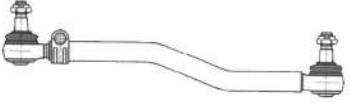

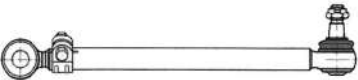

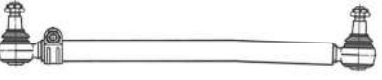

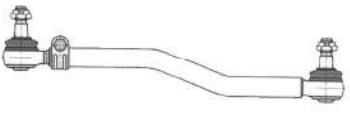

BARRE ACCOPPIAMENTO - TIE RODS

RIF. OCAP OCAP REF.	RIF. ORIG O.E. NUMBER	NOTE REMARKS	MODELLO / DESCRIZIONE MODEL / DESCRIPTION
0507288   0186598 M=30x1,5 RHT 0196598 M=30x1,5 LHT 	8165309 8165309 41005460 41005309	L=1560	EUROCARGO: 150 - EUROTRAKKER: 190-260 - 340-410 - E. TRAK CURSOR: 190-340-380 - 410-720 - E. TRAK: 380
0509421   0186598 M=30x1,5 RHT 0196598 M=30x1,5 LHT 	504144266 504144266 5801692437	L=1620 T=42	EUROCARGO I - II - III







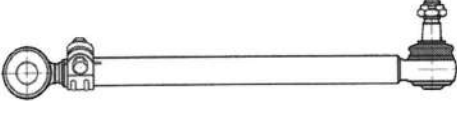

TIRANTI LONGITUDINALI - DRAG LINKS

RIF. OCAP OCAP REF.	RIF. ORIG O.E. NUMBER	NOTE REMARKS	MODELLO / DESCRIZIONE MODEL / DESCRIPTION
0506725  0186614 M=18x1,5 RHT	8557536 8557536 9009500	Lt=663	35 NC-40/45 NC - 49 NC-OM 35-OM 40 - OM 45-OM 50 U.T.
0506887  0186424 M=30x1,5 RHT	8590435 8590435	L=715	95.14-95.14Z - 109.14
0506851  0186424 M=30x1,5 RHT	2454629 2454629	L=689	120-13ANW - 120-17ANW - 130-13AH/AN - 150-16 ANW - 160-17AN-ANW
0506927  0186598 M=30x1,5 RHT	41016964 41016964 8136061 41005456 41005466	L=698	EUROTRAKKER: - 340E34/37/42 - 410E37/E42
0506812  0186424 M=30x1,5 RHT	8570528 8570528	L=708	con s/sterzo e cab.ribalt. - (with power steering and tilting cab) - ZETA: - 50.9Z-65.9-79.14 - TURBO ZETA: - 60.11-65.12/H-79.12 - 60F10-60.10 - 79F10-79F13-79.10-79.13-79.14 - 90.13/F13
0507306  0186598 M=30x1,5 RHT	42043295 42043295 42043909 42043910	L=744	190.25 AN/ANT/ANW - 190.30 N 260.25 AN - 330.30 AN/ANW/NW - MAGIRUS
0507164  0186424 M=30x1,5 RHT	8573757 8573757	L=750	100.13/F13 2?d tilting cab)
0506736  0186608 M=28x1,5 RHT	8567618 8567618 8582350 8567619	L=755	con s/sterzo e cabina fissa - (with power steering and fixed cab) - 50.8-50.10/F10 - 60.10/F10-65.10/F10 - 65.9Z-79.10-79.13-79.14 - 90.13/F13 - ZETA

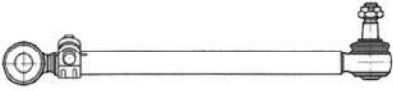





TIRANTI LONGITUDINALI - DRAG LINKS

RIF. OCAP OCAP REF.	RIF. ORIG O.E. NUMBER	NOTE REMARKS	MODELLO / DESCRIZIONE MODEL / DESCRIPTION
0506858  0186598 M=30x1,5 RHT	2519077 2519077	L=764	190.26NT
0506737  0186612 M=24x1,5 RHT	8591219 8591219 8564248	L=766	con s/sterzo e cab.ribalt. - (with power steering and tilting cab) - 60.10/F10-75.10/F10 - 79.10/F10-79.13/F13 - 90.13/F13 - senza s/ sterzo e cab. ribalt. - (without powersteering and tilting cab) - 50.9Z-60.11 - 5.12-79.12 T.ZETA
0506728  0186613 M=28X1,5 RHT	8558540 8558540 8558541	L=778	65/70/75/80/90NC - OM65/70/75/80/90 - (*): (giuda DX- RH drive 75NC-OM75)
0507859  0186424 M=30x1,5 RHT	500324282 500324282	L=785	TECTOR: - 120E17/E21 - EUROARGO: - 120EL15/EL18/EL21
0506856  0186598 M=30x1,5 RHT	42043293 42043293 42043908	L=796	160.23ANW - 170.23AHW - 190.25AN/ANT - MAGIRUS
0506854  0186598 M=30x1,5 RHT	2461519 2461519	L=810	190.19ANW - 190.26NT
0506814  0186424 M=30X1,5 RHT	2458534 2458534	L=816	256M26K
0506951  0186424 M=30x1,5 RHT	98402544 98402544 98467459	L=822	EUROARGO: - 60E10/E12/E14 - 65E10/E12/E14 - 75E10/E12/ E14/E15 - 80E15/E18/E21 - 100E15/E18/E21 - 120E15/18/23 - 130E15/18/23 - 150E18/E23/E27 - 180E21 - 260E23 - 280E23 - 320E27



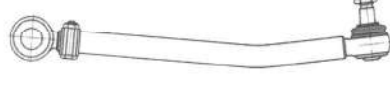
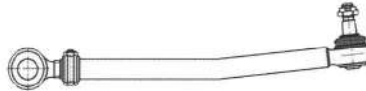













TIRANTI LONGITUDINALI - DRAG LINKS

RIF. OCAP OCAP REF.	RIF. ORIG O.E. NUMBER	NOTE REMARKS	MODELLO / DESCRIZIONE MODEL / DESCRIPTION
0507287  0186598 M=30x1,5 RHT	41016961 41016961 8135492 41005469 41011476 41016960	L=824	EUROSTAR: - 400 - EUROSTAR CURSOR: - 400 - EUROTECH: - 400 E34/38/42 - E.TECH CURSOR: 440 - STRALIS: 440 S40/43/ 48/54
0506726  0186612 M=24x1,5 RHT	8591222 8591222 8558522 8559559	L=830	50/55 NC-50.8/F8 - 50.9/F9-50.10/F10 - 50.9Z-55.8/F8-55.9/F9 - 55.10/F10 - 60.8/F8-60.10/F10 - 60.11 TURBO ZETA-65.10/F10 - 70.10/F10-75.10-79.10 - 79.13/14-80.13-90.12 - 83.10/F13-90.13/ F13 - OM 50-OM 55
0506897  0186598 M=30x1,5 RHT	41016958 41016958 8135446 41005472	L=832	EUROSTAR: - 400E38/42/47 - E.STAR CURSOR: - 440E39/43 - EUROTECH: - 400E34/38 - STRALIS: - 440s40/43/44/48/54
0506860  0186598 M=30x1,5 RHT	2444423 2444423	L=852	220-32AHT
0507347  0186424 M=30x1,5 RHT	42023779 42023779 42023778	L=872	120-17
0506928  0186613 M=28x1,5 RHT	42211148 42211148 42211146 42200700 42204475	L=874	80-13A2/A3/AW 80 - 16A4 80-13ABP 90-13A
0507321  0186613 M=28x1,5 RHT	80003410 80003410	L=874	75-9A
0506956  0186598 M=30x1,5 RHT	98469650 98469650 98449025	L=878	EUROCARGO: - 170E15/E18/E23 - TECTOR: - 180E21/E24/E28 - 260E23/27/28KE - TECTOR RESTYLING









TIRANTI LONGITUDINALI - DRAG LINKS

RIF. OCAP OCAP REF.	RIF. ORIG O.E. NUMBER	NOTE REMARKS	MODELLO / DESCRIZIONE MODEL / DESCRIPTION
0507367  0187364 M=30x1,5 RHT	500336085 500336085 500308895 99455009	L=883 T=52	490 - 490.18.19 - 590 E2 - CITYCLASS
0507851 	98493054 98493054	L=887	EUROCARGO: - 150E15/E18/E21
0507904  0186598 M=30x1,5 RHT	41298449 41028269 41298449	L=887	EUROTRAKKER - MP 340 - MP 410 - 1993 > 11/2004
0506855  0186598 M=30x1,5 RHT	42001326 42001326 42001325 42086458	L=890	160-23AH/AHW - 160-30AHW - 170-23 AH/AHB - 190-26H/HW - 200-32AHW - 260-30AH/AHT/AHW - 300-25AHB-330.26/F26 - 330-30/30H 2ªserie - 330-35/F35 - 330.36 - 260-34AH - (rinforzato-stiffened) - MAGIRUS
0507301  0186424 M=30x1,5 RHT	42035419 42035419 42035418	L=895	75-13 AWM
0506952  0186424 M=30x1,5 RHT	4854874 4854874	L=897	EUROCARGO: - 120E15/E18/E23 - 130E15/E18/E23 - 140E15/E18/E23 - 150E18/E23/E27R - 260E23T-280E23T - 320E27T - EUROFIRE
0507368  0186598 M=30X1,5 RHT	504049893 504049893	L=897 T=42	EUROCARGO: 120-130-140-150-160
0506893  0186595 M=24x1,5 RHT	80003408 80003408 42204473 80003406	L=898	75-9AH - 80-9A - 80-9AH - 70M6FL - 90M6FL/FK





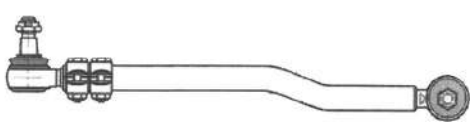

TIRANTI LONGITUDINALI - DRAG LINKS

RIF. OCAP OCAP REF.	RIF. ORIG O.E. NUMBER	NOTE REMARKS	MODELLO / DESCRIZIONE MODEL / DESCRIPTION
0506894   0186598 M=30x1,5 RHT	98446354 98446354	L=901	EUROTECH: - 180E24/27/30/34 - 190E24/27/30 - 325E27 - 400E30/34
0506828   0186424 M=30x1,5 RHT 0186424 M=30x1,5 RHT 	42202358 42202358 42203459	L=904	110-13A/16A - 130M11FL - 160M11FS/FK/FL
0506848   0186598 M=30x1,5 RHT	42042950 42042950 42043912	L=910	190-26H/30H - 260-26H/30H/35H - 330-26H/35H - 330-30H (1ª serie) - 330-36 (1ª serie) - (rinforzato-stiffened)
0506743   0186599 M=38x1,5 RHT	61593332 61593332	Lt=937	159NC LHD - 159NC 20
0507293   0186598 M=30x1,5 RHT	41005475 41005475 41006093	L=952	EUROTRAKKER: - 180-190-260 - 330-400-410 - E.TRAK CURSOR: - 180-190-380
0506931   0186598 M=30x1,5 RHT	41005463 41005463 8131582 8132397 41042919	L=953	EUROSTAR - EUROSTAR CURSOR - EUROTECH - EUROTECH CURSOR - EUROTRAKKER - EUROTRAKKERCURSOR - STRALIS
0507365 	5801282537 5801282537 5801282538	L=953 T=50	EUROSTAR - EUROTECH - EUROTRAKKER - STRALIS - TRAKKER
0507370   0186598 M=30x1,5 RHT	41226580 41215165 41226580	L=959 T=52	EUROTRAKKER - TRAKKER

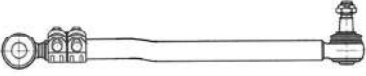

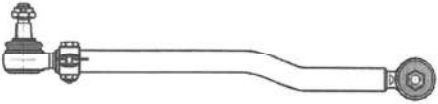









TIRANTI LONGITUDINALI - DRAG LINKS

RIF. OCAP OCAP REF.	RIF. ORIG O.E. NUMBER	NOTE REMARKS	MODELLO / DESCRIZIONE MODEL / DESCRIPTION
0507369  0186598 M=30x1,5 RHT	500397738 500397738	L=959 T=36	EUROSTAR - EUROTECH - STRALIS
0507850  0186598 M=30x1,5 RHT	98473328 98473328	L=966	EUROCARGO: - 95E15-95E21-135E18-135E23 - EUROFIRE: - 95E18-135E22-135E24-140E24-140E28 - TECTOR: - 100E18-100E21-150E18-150E24
0506810  0186599 M=38x1,5 RHT 0196599 M=38x1,5 LHT	4704183 4704183	L=970	370S12/S24/S35 - 260R106/R119
0507310  0186598 M=30x1,5 RHT	42087848 42087848 42078019	L=974	TURBOTECH: 220-36 PT
0507309  0186598 M=30x1,5 RHT	42087846 42087846	L=974	TURBOTECH: 220-36 PT
0506717  0186599 M=38x1,5 RHT	4699305 4699305	L=975	170NC26-170NC33 - 170NT26-170NT33 - 170NC35-170NT35 - 190NC26-190NC33 - 190NT26-190NT33 - 190NC35-190NT35 - guida DX (RH drive)
0506839  0186599 M=38x1,5 RHT	4715615 4715615	L=975	160-26/26T - 170.20 - 170-26/F26/F26T - 170-35 - 190.20 - 190-26/F26/F26T - 190-35 - 190-38 - 240-26 - 240-35 - TURBOTECH
0507161  0186599 M=38x1,5 RHT	4722108 4722108	L=975	220 F 38 TURBO

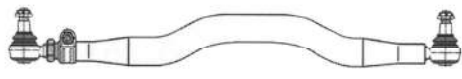
TIRANTI LONGITUDINALI - DRAG LINKS

RIF. OCAP OCAP REF.	RIF. ORIG O.E. NUMBER	NOTE REMARKS	MODELLO / DESCRIZIONE MODEL / DESCRIPTION
0506716  0186599 M=38x1,5 RHT	4699246 4699246	L=976	170NC26-170NC33 - 170NT26-170NT33 - 170NC35-170NT35 - 190NC26-190NC33 - 190NT26-190NT33 - 190NC35-190NT35
0506820  0186608 M=28x1,5 RHT	4834037 4834037 4773359	L=979	115-14 - 115-17 - 135-14 - 135-17 - 145-17 - 150 - 159-17
0506915  0186424 M=30x1,5 RHT	4815933 4815933	L=979	145.17 - EUROSTAR - EUROSTAR CURSOR
0506840  0186598 M=30x1,5 RHT	42087842 42087842 4747690 4747961 42087841 4207841 4747960	L=982	190 - TURBOSTAR - TURBOTECH
0506745  0186424 M=30x1,5 RHT	61595371 61595371	L=982	150NC 17 - 150NC 20
0506741  0186424 M=30x1,5 RHT	61590910 61590910	L=985	150NC17/20
0507303  0186598 M=30x1,5 RHT	42039631 42039631	L=993	280M26FS
0506826  0186599 M=38x1,5 RHT	4793166 4793166 4834041	L=1001	165.24 - 175.17 - 175.24



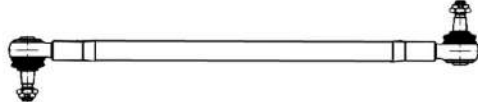

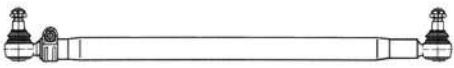

TIRANTI LONGITUDINALI - DRAG LINKS

RIF. OCAP OCAP REF.	RIF. ORIG O.E. NUMBER	NOTE REMARKS	MODELLO / DESCRIZIONE MODEL / DESCRIPTION
0506746 	61595960 61595960 61590824	L=1025	veicoli con cabina ribaltabile - (vehicles with tilting cab) - 130NC-NR-NT - OM130/R/T
0507163  0187158  M=25x1,5 RHT	61595957 61595957 61591070	L=1025	100NC-110PC - OM110-OM110 - OM110P - guida SX (LH drive) - cabina ribaltabile (tilting cab)
0507853  0186424  M=30x1,5 RHT	500363545 500363545	L=1114	EUROCARGO - TECTOR 120E118
0507852  0186424  M=30x1,5 RHT	500362533 500362533	L=1190	EUROCARGO - TECTOR 130E24
0507314  0187314  M=30x1,5 RHT	42118694 42118694 42115532	L=1485	EUROTRAKKER: - 190E31 - E.TRAKKER CURSOR: - 180E24/27 - 190E231/35/38/44 - 260E35/38/44 - 380E35/38/44 - 410E44 720E44
0507371 	8166702 8166702	L=1540 T=48	EUROTRAKKER MP 340-410
0507866  0186598  M=30x1,5 RHT	504034521 504034521	L=1570	TECTOR: - 180E21-180E24-180E28 - 260E28KE
0507207 	41032826 41032826	L=1590	
0507284 	42088124 42088124 4720262	L=2421	TURBOTECH: - 220-36 PT





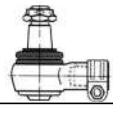

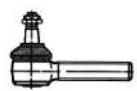
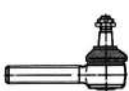
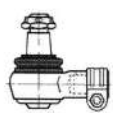

TIRANTI LONGITUDINALI - DRAG LINKS

RIF. OCAP OCAP REF.	RIF. ORIG O.E. NUMBER	NOTE REMARKS	MODELLO / DESCRIZIONE MODEL / DESCRIPTION
<p>0506764</p>  <p>0186598 M=30x1,5 RHT</p>	<p>4765442 4765442</p>	<p>L=2460</p>	<p>470.20-471.20 - U.EFFEUNO - 570.20-571.20-670.20 - 260SH110-260SH170</p>

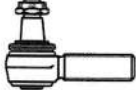

TESTE STERZO - TIE RODS END

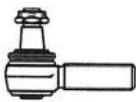
RIF. OCAP OCAP REF.	RIF. ORIG O.E. NUMBER	NOTE REMARKS	MODELLO / DESCRIZIONE MODEL / DESCRIPTION
0287361 	42533073 42533073	L=75 M=26x1,5 RHT	EUROSTAR - STRALIS
0280513 	9750079980 9750079980 4336779	L=80 M=16x1,5 RHT	FIAT - DUCATO - TALENTO
0280515 	93800662 93800662 93804059 1903652	L=80 M=16x1,5 RHT	OM GRINTA - FIAT 28.8-30.8 - 30.9-32.8/9/10 - 40.8-45.10-49.10
0287906 	42533102 42533102 1394446	L=80 M=26x1,5 RHT	EUROSTAR - EUROTECH - STRALIS
0287313 	42105474 42105474 42532294	L=85 M=26x1,5 RHT	EUROTRAKKER: - 340E34/37/42 - 410E37/42 - E.TRAKKER CURSOR: - 340E35 410E35
0287320 	42530316 42530316 42538047 93157156	L=86 M=30x1,5 RHT	320-32AHB - EUROTRAKKER: - 340E34/37/42 - 410E37/42 - E. TRAK CURSOR: - 340E35 410E35
0287360 	42533101 42533101	L=90 M26x1,5	EUROSTAR - STRALIS
0289923 	42538048 1271126 42538048 82953016019 81953016268 82953016018 3099128 3090291	L=90 M=36x1,5	
0186614 	9009501 4579231 9009501	L=98 M=18x1,5 RHT	35 NC-40/45 NC - OM 40 U.T. - 625N1/N2/N3
0196614 	9009503 4579232 9009503	L=98 M=18x1,5 LHT	35 NC-40/45 NC - OM 40 U.T. - 625N1/N2/N3
0287291 	9281792 9281792	L=95 M=24x1,5 RHT	









TESTE STERZO - TIE RODS END

RIF. OCAP OCAP REF.	RIF. ORIG O.E. NUMBER	NOTE REMARKS	MODELLO / DESCRIZIONE MODEL / DESCRIPTION
0186595 	42491937 42491937 42480024	L=95 M=24x1,5 RHT	70M6FL - 75.9A - 80.9 - 90M6FL/FK
0196595 	42480023 42480023 8193649	L=95 M=24x1,5 LHT	70M6FL - 75.9A - 80.9 - 90M6FL/FK
0187158 	61595957 61595957 61591070	L=105 M=25x1,5 RHT	100NC - 110PC-OM110 - OM110P - cabina ribaltabile - (tilting cab)
0186613 	42484886 42484886 4833825 8193645 8558533 8582322 2966321 2966635	L=105 M=28x1,5 RHT	50-60.8/9/10 - 65-79.10 GAMMA ZETA - 80-90.13-79.12/13/14 - 80-90 NC-109.14 - OM 65-OM 70-OM 75 - ZETA - TURBOZETA
0196613 	42484887 42484887 4833826 8123394 8193646 8558536 2969507	L=105 M=28x1,5 LHT	50-60.8/9/10 - 65-79.10 GAMMA ZETA - 80-90.13-79.12/13/14 - 80-90 NC-109.14 - OM 65-OM 70-OM 75 - ZETA - TURBOZETA
0186612 	8558527 8558527 42487165 93194626	L=105 M=24x1,5RHT	50 NC-55 NC - OM 50-OM 55 - ZETA - TURBOZETA
0196612 	8558524 8558524 7984276 93194627	L=105 M=24x1,5LHT	50 NC-55 NC - OM 50-OM 55 - ZETA - TURBOZETA
0187278 	2981461 2981461	L=115 M=28x1,5 RHT	
0186608 	4688941 4688941 8582332 7167757 8565366	L=115 M=28x1,5 RHT	50.8-60.10-65.10-65.9 ZETA-79.10-79.12 - 79.13-79.14-90.13-109.14-115.14 - 100.13-109.14-115.14 - 135.14-130NR20-140.14-145.17-150.14 - TURBOZETA
0196608 	4688942 4688942 8582333	L=115 M=28x1,5 LHT	50.8-60.10-65.10-65.9 ZETA-79.10-79.12 - 79.13-79.14-90.13-109.14-115.14 - 100.13-109.14-115.14 - 135.14-130NR20-140.14-145.17-150.14 - TURBOZETA

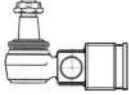
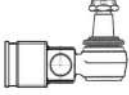
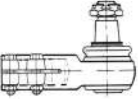
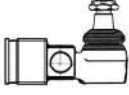



TESTE STERZO - TIE RODS END

RIF. OCAP OCAP REF.	RIF. ORIG O.E. NUMBER	NOTE REMARKS	MODELLO / DESCRIZIONE MODEL / DESCRIPTION
0186424 	42493781 2966688 2980323 3096213 42483520 42485718 42493781 4833820 4833827 8122754	L=115 M=30x1,5 RHT	ZETA - EUROCARGO - MK - PEGASO
0196424 	42493782 2980129 2984511 42493782 4833821 4833828 8122755	L=115 M=30x1,5 LH	ZETA - EUROCARGO - MK - PEGASO
0186604 	4028250 4028250 4663972	L=117 M=28x1,5 RHT	
0281143 	1306716080 1306716080	L=118 M=16x1,5 RHT	FIAT - DUCATO - TALENTO
0186598 	2966252 4833829 42537936 42488269 42483386 4802443 2969808 42489594	L=120 M=30x1,5 RHT	EUROCARGO - EUROSTAR - EUROTECH - STRALIS
0196598 	2984061 4833830 42491957 4802444 2984061 8190225 42489395		EUROCARGO - EUROSTAR - EUROTECH - STRALIS
0187146 	2980875 2980875	L=120 M=30x1,5 RHT	
0186599 	4688948 4688948	L=120 M=38x1,5 RHT	165.24-170.26-170.35-175.24 - 170.17-180.24 - TURBOTECH - TURBOSTAR
0196599 	4688949 4688949	L=120 M=38x1,5 LHT	165.24-170.26-170.35-175.24 - 170.17-180.24 - TURBOTECH - TURBOSTAR









TESTE STERZO - TIE RODS END

RIF. OCAP OCAP REF.	RIF. ORIG O.E. NUMBER	NOTE REMARKS	MODELLO / DESCRIZIONE MODEL / DESCRIPTION
0187364 	500309296 500309296	L=139 M=30x1,5 RHT	EUROSTAR LD - EUROTECH MH-MP - STRALIS AD-AS
0188994 	42538384 42538384	L=140 M=30x1,5 RHT	
0186656 	4688951 4688951	M=64x1,5 RHT RHD	170NC26/NC33/NC35 - 170NT26/NT33/NT35 - 190NC26/NC 33/NC35 - 190NT26/NT33/NT35 - - Servosterzo - (Power steering axle)
0186655 	4688952 4688952	M=64x1,5 RHT LHD	170NC26/NC33/NC35 - 170NT26/NT33/NT35 - 190NC26/NC 33/NC35 - 190NT26/NT33/NT 35 - - Servosterzo - (Power steering axle)
0287159 	4688946 4688946	M=30x1,5 RHT	60.10/.F10-60.11 T. ZETA - 65.9/.12-65.10/.F10 T.ZETA - 79.10/.F10/.12 T.ZETA - 90.13/.F13 100.13/.F13-109.14 ZETA - 115.14-115.17-135.14/.14H-135.17 e deriv. - 145.17-150.14/.17 - 150.NC17/20/NR20/NT20 - - Servosterzo - (Power steering axle)
0187160 	4688944 4688944	M=64x1,5 RHT	60.10/.F10 - 60.11 T. ZETA - 65.9/.12-65.10/.F10 T.ZETA - 79.10/.F10/.12 T.ZETA - 90.13/.F13 100.13/.F13-109.14 ZETA - 115.14 - 115.17-135.14/.14H - 135.17 e deriv.-145.17 - 150.14/.17 - 150.NC17/NC20/NR20/NT20 - - Servosterzo - (Power steering axle)
0288003 	- -	L=76 M=26x1,5 RH	Testa per servosterzo terzo asse - (Tie rod end for power steering axle)
0287238 	93192809 93192809	L=91 M=30x1,5 RH	E.TRAKKER:190E30/42 - 380E42 - EUROSTAR: 240E38/42/47/52 - EUROTECH: 240E25/30/38/42 - - Testa per servosterzo terzo asse - (Tie rod end for power steering axle)
0289425 	42569563 42569563	L=109 M=16x1,5 RHT	DAILY VI
0289426 	42569562 42569562	L=87 M=16x1,5 RHT	DAILY VI
0289476 	500053864 500053864	L=80 M=18x1,5 RHT	DAILY (70C16)





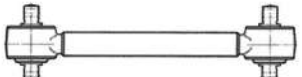
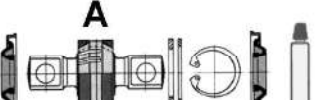





SNODI ASSIALI - AXIAL JOINTS

RIF. OCAP OCAP REF.	RIF. ORIG O.E. NUMBER	NOTE REMARKS	MODELLO / DESCRIZIONE MODEL / DESCRIPTION
0600516 	9983325 9983325	L=310 M=16x1,5 RHT	DAILY I - II
0602749 	2992593 2992593	L=367 M=16x1,5 RHT	DAILY III - IV - V
0606927 	7820249212 7820249212	M=16x1,5 RHT	DAILY I - II
0607552 	42532977 42532977 99463268	L=348 M=16x1,5 RHT	DAILY III - IV
0609422 	42569566 42569566	L=348 M=18x1,5 RHT	DAILY VI



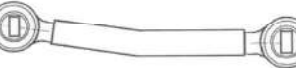

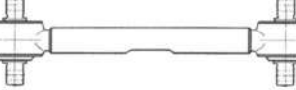
BARRE DI REAZIONE - TORQUE RODS

RIF. OCAP OCAP REF.	RIF. ORIG O.E. NUMBER	NOTE REMARKS	MODELLO / DESCRIZIONE MODEL / DESCRIPTION
0807225 	41009961 41009961	L=455	
0907327 	93192361 93192361	L=130 p=24 D=62 d=19	
0807226 	41033731 41033731	L=455	
0907327 	93192361 93192361	L=130 p=24 D=62 d=19	
0807363 	41218021 41218021	L=582 T=60	TRAKKER AD - AT
0907330 	93192619 93192619 42493431	L=152 p=24 D=80 d=21	
0807209 	42125057 42125057 98488010 4714134	L=582 d=19	190.30-240.30 - TURBOSTAR: - 190.36/42/48 - TURBOTECH: - 190.32/36-220.32/36
0907578 	93161371 93161371	L=130 D=65 d=19	
0907586 	093161371 0005861533 093161371	D=65	senza perno (without pin)
0807213 	98488010 98488010	L=583 d=19	TURBOSTAR: - 190.30/.36/.42/.48 - 240.30 - TURBOTECH: 190



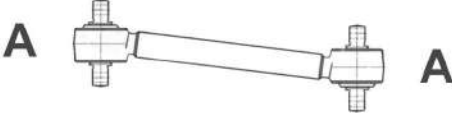
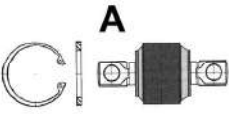
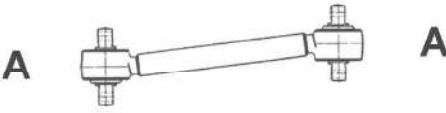

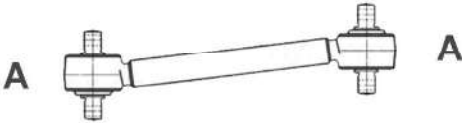
BARRE DI REAZIONE - TORQUE RODS

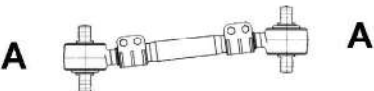
RIF. OCAP OCAP REF.	RIF. ORIG O.E. NUMBER	NOTE REMARKS	MODELLO / DESCRIZIONE MODEL / DESCRIPTION
0907259 A 	42488722 42488722 2969844	l=130 p=30 D=70 d=19	
0807207 A  A	4714134 4714134	L=583 d=19	175.24-190.30-240.30 - EUROCLASS - TURBOSTAR: - 190.33/ .36/.42/.48 - TURBOTECH: - 190.32/.32GV/.36/.36GV - 220.32/ .36/.38 -240.32/.32GV/.36
0907258 A 	2980884 2980884 81432206132	l=130 p=30 D=65 d=19	
0907757 A 	2980884 Z -	D=65	SENZA PERNO (without pin)
0807358 A  A	41035951 41035951 41009661 8137027 98472466	L=590 d=19	EUROCARGO - EUROMOVER - EUROSTAR - EUROSTAR CURSOR - EUROTECH - EUROTRAKKER CURSOR - TECTOR - TECTOR RESTYLING - STRALIS
0907327 A 	93192361 93192361	l=130 p=24 D=62 d=19	
0807292 A  A	500340452 500340452 41003268	L=594 d=19,5	EUROMOVER: 260 - EUROSTAR:240 400 - E.STAR CURSOR:260 - EUROTECH:2402 260 440 - EUROTECH CNG:240 - E.TECH CURSOR:260 - STRALIS:260
0907327 A 	93192361 93192361	l=130 p=24 D=62 d=19	
0807336 A  A	98472871 98472871	L=594 d=19	EUROTECH: - 180E24/E27/E30/E34 - 190E24/E27/E30 - 400E30/E34
0907327 A 	93192361 93192361	l=130 p=24 D=62 d=19	



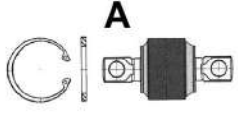
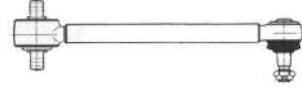
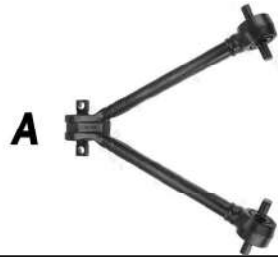

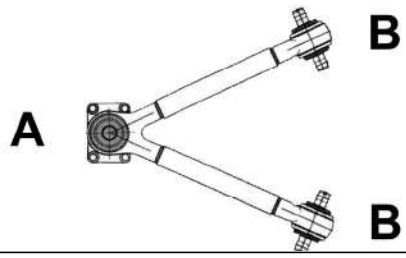
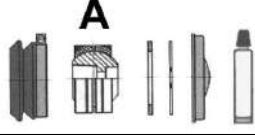
BARRE DI REAZIONE - TORQUE RODS

RIF. OCAP OCAP REF.	RIF. ORIG O.E. NUMBER	NOTE REMARKS	MODELLO / DESCRIZIONE MODEL / DESCRIPTION
0507192 	4670853 4626261 4670853	L=610	FIAT: - 300 PC- 697 N- 697 NP
0807262 	42034054 42034054 42000481	L=610 d=21	330.26 - 330.30 Turbo - 330.35-330.36 - TURBOTECH
0907262 	2983125 2983125	l=152 p=35 D=80 d=21	
0807295 	42065332 42065332 41011006	L=610 d=21	330.26H - 330.30AN/H/N/NW - 330.36H - EUROTRAKKER: - 330E34/E37 - 340E42 - 380/E31/E34/E37/E42 - 410E37/E42 720E31/E37/E42 - E.TRAKKER CURSOR: - 380E42/44 -720E42/ E44 - TRAKKER:AD/AT
0907330 	93192619 93192619 42493431	l=152 p=24 D=80 d=21	
0807579 	42041107 42041107	L=610 d=21	EUROCARGO - EUROSTAR - EUROTCH - EUROTCH CURSOR - EUROTRAKKER - EUROTRAKKER CURSOR - STRALIS AD/AT
0907304 	93192618 93192618	l=152 p=24 D=70 d=21	
0807298 	42034051 42034051 42000486	L=630 d=21	330 F26/.26H- 330F35/.35H - 330F35T/.35HT- 330.30H/.30HT - 330.36H



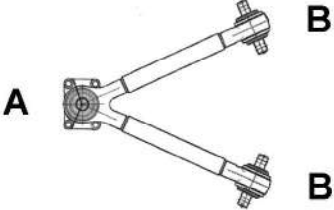
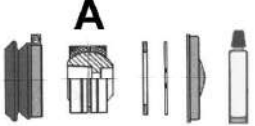

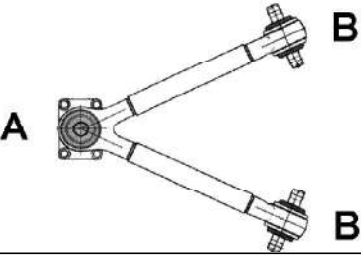
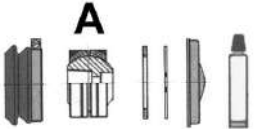
BARRE DI REAZIONE - TORQUE RODS

RIF. OCAP OCAP REF.	RIF. ORIG O.E. NUMBER	NOTE REMARKS	MODELLO / DESCRIZIONE MODEL / DESCRIPTION
0907262 	2983125 2983125	l=152 p=35 D=80 d=21	
0807326 	97104296 97104296 93165049	L=640 d=15	490 - 590E22 - 590E2
0807374 	41296730 41296730 41296731	L=665 T=48 l=152 d=25	STRALIS AD - AS
0907774 	41272706 Z 41272706 Z 0003502405 81432706110	l=152 p=24 D=80 d=25	
0807282 	4463926 4463926	L=647 d=19	TURBOTECH: - 190-26T/32T/36 T - 220-32/36 - 240-32/36 - TURBOSTAR: - 190-33P-190-33T/36T/42T/48T
0907257 	2968454 2968454	L=50 IK=38 D=65	
0907258 	2980884 2980884 81432206132	l=130 p=30 D=65 d=19	
0907757 	2980884 Z -	D=65	SENZA PERNO (without pin)

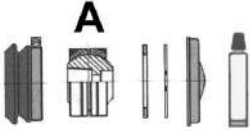

BARRE DI REAZIONE - TORQUE RODS

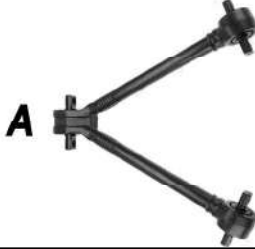
RIF. OCAP OCAP REF.	RIF. ORIG O.E. NUMBER	NOTE REMARKS	MODELLO / DESCRIZIONE MODEL / DESCRIPTION
0807208 	4716271 4716271	L=647 d=19	190.30-190.38 - 220.38(1985)-240.30 - TURBOSTAR: - 190.36/42/ 48 - TURBOTECH: - 190.32/36 - 220.32/36 - 240.32/36
0907257 	2968454 2968454	L=50 IK=38 D=65	
0907258 	2980884 2980884 81432206132	l=130 p=30 D=65 d=19	
0907757 	2980884 Z -	D=65	SENZA PERNO (without pin)
0807257 	4716799 4716799	L=647 d=19	190.38 (1 Serie-Chassis) - 220.38 (1983) - 240.30 - TURBOSTAR: - 190-33 P-190-33 T - 190-42 T - TURBOTECH: - 190-26 T-190-32 T - 190-36 T-240.32-240.36
0907257 	2968454 2968454	L=50 IK=38 D=65	
0907258 	2980884 2980884 81432206132	l=130 p=30 D=65 d=19	
0907757 	2980884 Z -	D=65	SENZA PERNO (without pin)





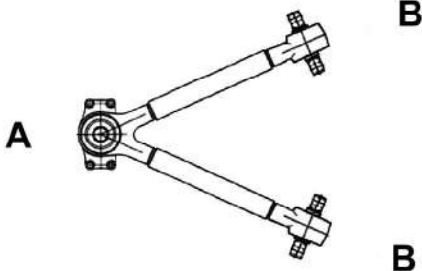
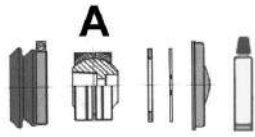
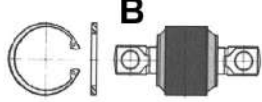
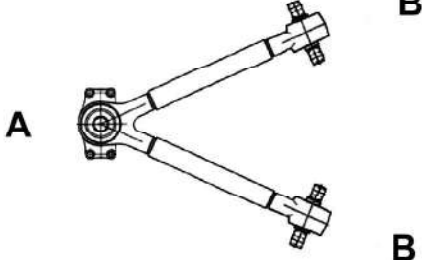
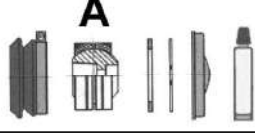
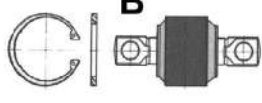

BARRE DI REAZIONE - TORQUE RODS

RIF. OCAP OCAP REF.	RIF. ORIG O.E. NUMBER	NOTE REMARKS	MODELLO / DESCRIZIONE MODEL / DESCRIPTION
0807296 	41028599 41028599 41042092 41022092 98472468	L=665 d=21	EUROCARGO: - 120E15/E18/E23 - 130E15/18/E23/E24 - 150E15/E18/E23/E27 - 170E18/E23/E27 - 260E23-280E23- 320E27 - EUROTECH: - 180E24/E27/E30/E34 - 190E24/E27/E30 - 325E27 400E24/E30 - TECTOR: - 130E28-150E18/E24 - 150E24-180E21/E24/E28 - 320E28T
0907297 	93161958 93161958 93162239	D=65 IK=38	
0907327 	93192361 93192361	l=130 p=24 D=62 d=19	
0807372 	41218621 41218621	L=665 T=48 l=152/130 d=25/21	STRALIS AD - AS
0807373 	41272706 41272706	L=665 T=48 l=152 d=25	STRALIS AD - AS
0907774 	41272706 Z 41272706 Z 0003502405 81432706110	l=152 p=24 D=80 d=25	



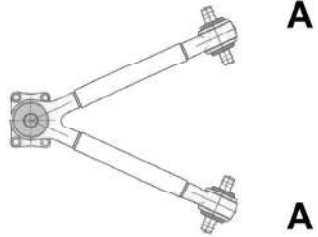

BARRE DI REAZIONE - TORQUE RODS

RIF. OCAP OCAP REF.	RIF. ORIG O.E. NUMBER	NOTE REMARKS	MODELLO / DESCRIZIONE MODEL / DESCRIPTION
0807211 	41042050 41042050 41028598 41002770 8137026 41009665 41028600 41029665 41033479 41035950 41034479	L=665 d=21	EUROCARGO - EUROMOVER:190E24-260E24 - EUROSTAR:180E38/E42 - 190E38/E42/E47/52 - 240E38/E42/ E47/E52 - 400E38/E42/E47E52 - 440E38/E42/E47 - E.STAR CURSOR:190E39/E43 - 440E39 - EUROTECH:180E34/E38 - 400E34/E38 - CNG - E.TRAK CURSOR:260E31/E35 - 340E38/ E35 - STRALIS:260S40/S43 - AD - AT - TECTOR
0907297 	93161958 93161958 93162239	D=65 IK=38	
0907296 	93161960 93161960 93162361	l=130 p=24 D=62 d=21	
0807299 	41042093 41042093 500340451	L=665 d=21	E. STAR CURSOR: - 190/E39/E43 - E. TECH CURSOR: - 190/ E31/E35/E43 - STRALIS: - 190S40/S43/S48 - 260E40/E43/E54 - EURTRAKKER CURSOR
0907299 	93161631 93161631 93161638	L=46 IK=38 D=65	
0907296 	93161960 93161960 93162361	l=130 p=24 D=62 d=21	
0807308 	42086282 42086282	L=665 d= 19	TURBOTECH: - 220-32/36 - TURBOSTAR



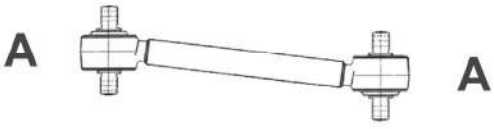







BARRE DI REAZIONE - TORQUE RODS

RIF. OCAP OCAP REF.	RIF. ORIG O.E. NUMBER	NOTE REMARKS	MODELLO / DESCRIZIONE MODEL / DESCRIPTION
0907258 	2980884 2980884 81432206132	l=130 p=30 D=65 d=19	
0907757 	2980884 Z -	D=65	SENZA PERNO (without pin)
0807283 	4719609 4719609	L=677 d=19	TURBOTECH: 220.38
0907258 	2980884 2980884 81432206132	l=130 p=30 D=65 d=19	
0907757 	2980884 Z -	D=65	SENZA PERNO (without pin)
0807286 	4855237 4855237	L=678 d=19	175.24
0907258 	2980884 2980884 81432206132	l=130 p=30 D=65 d=19	
0907757 	2980884 Z -	D=65	SENZA PERNO (without pin)

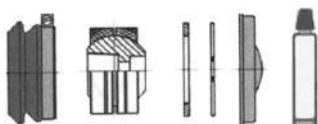





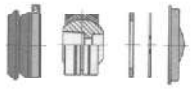

BARRE DI REAZIONE - TORQUE RODS

RIF. OCAP OCAP REF.	RIF. ORIG O.E. NUMBER	NOTE REMARKS	MODELLO / DESCRIZIONE MODEL / DESCRIPTION
0807328 	97104299 97104299	L=803 d=19	490 - 490.12.22 - 490.18.29 - 500E2/E22
0907327 	93192361 93192361	l=130 p=24 D=62 d=19	
0809418 	93163964 93163964 99458576	L=635 T=28,7	EUROCARGO
0809448 	41272428 41272428	L=665 T=48 l=152/130 d=25/21	TRAKKER
0907774 	81432706110 41272706 0003502405 81432706110	l=152 p=24 D1=100 d=25	

KIT DI SOSPENSIONE - SUSPENSION KITS

RIF. OCAP OCAP REF.	RIF. ORIG O.E. NUMBER	NOTE REMARKS	MODELLO / DESCRIZIONE MODEL / DESCRIPTION
0907230 	504001436 504001436	l=115	
0907757 	2980884 Z -	D=65	TURBOTECH - SENZA PERNO (without pin)
0907327 	93192361 93192361	l=130 p=24 D=62 d=19	EUROCARGO
0907262 	2983125 2983125	l=152 p=35 D=80 d=21	
0907257 	2968454 2968454	L=50 IK=38 D=65	TURBOSTAR - TURBOTECH
0907258 	2980884 2980884 81432206132	l=130 p=30 D=65 d=19	TURBOSTAR - TURBOTECH
0907774 	41272706 Z 41272706 Z 0003502405 81432706110	l=152 p=24 D=80 d=25	STRALIS AD - AS
0907297 	93161958 93161958 93162239	D=65 IK=38	EUROCARGO
0907296 	93161960 93161960 93162361	l=130 p=24 D=62 d=21	EUROCARGO
0907407 	500333284 500333284	l=130 D=74,9 d=19	EUROSTAR - EUROTECH MP - STRALIS

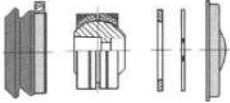

KIT DI SOSPENSIONE - SUSPENSION KITS

RIF. OCAP OCAP REF.	RIF. ORIG O.E. NUMBER	NOTE REMARKS	MODELLO / DESCRIZIONE MODEL / DESCRIPTION
0907299 	93161631 93161631 93161638	L=46 IK=38 D=65	E. STAR CURSOR: - 190/E39/E43 - E. TECH CURSOR: - 190/ E31/E35/E43 - STRALIS: - 190S40/S43/S48 - 260E40/E43/E54 - EURTRAKKER CURSOR
0907927 	93163617 93163617 093163617	p=24 D=67 d=19	EUROCARGO
0907330 	93192619 93192619 42493431	l=152 p=24 D=80 d=21	EUROTRAKKE MP - TRAKKER AD
0907304 	93192618 93192618	l=152 p=24 D=70 d=21	EUROCARGO - EUROSTAR - EUROTECH - EUROTECH CURSOR - EUROTRAKKER - EUROTRAKKER CURSOR - STRALIS AD/AT
0907586 	093161371 0005861533 093161371	D=65	190.30-240.30 - TURBOSTAR: - 190.36/42/48 - TURBOTECH: - 190.32/36-220.32/36
0907259 	42488722 42488722 2969844	l=130 p=30 D=70 d=19	TURBOSTAR: 190.30/.36/.42/.48 - 240.30 - TURBOTECH: 190
0907487 	2968454 2968454	IK=38 D=65	TURBOSTAR - TURBOTECH
0909422 	5801564281 5801564281 5801564274 5801564276	L=25,2 D=17 mm.	DAILY VI ASSE ANTERIORE - FRONT AXLE









SNODI SOSPENSIONI - SUSPENSION JOINTS

RIF. OCAP OCAP REF.	RIF. ORIG O.E. NUMBER	NOTE REMARKS	MODELLO / DESCRIZIONE MODEL / DESCRIPTION
0280517 	93802209 93802209 93804060 500310933	L=72 M=20x1,5 RHT	OM GRINTA - FIAT 28.8-30.8/9 - 32.8/9/10 - 40.8-45.10 - 49.10
0187157 	2460515 2460515	L=95	330.26/30/35H - 330.30/35HT
0400097 	4388159 4388159	m=14x1,5	FIAT - DUCATO - TALENTO
0400096 	7567284 7567284	m=16x1,5	FIAT - DUCATO - TALENTO
0401137 	1302368080 1302368080	m=16x1,5	FIAT - DUCATO - TALENTO
0401138 	1300473080 1300473080	m=18x1,5	FIAT - DUCATO - TALENTO
0401451 	1331641080 1331641080	m=16x1,5	FIAT - DUCATO - MOD. 1.8 t - CH. 6087206 >
0401446 	1300473080 1331640080 364055 3640.55	m=18x1,5	FIAT - DUCATO - MOD. 1.0 - 1.4 t. - CH. 6086766 >
0400518 	93807545 93807545 93802242	m=18x1,5	OM GRINTA - FIAT 28.8-30.8/9 - 32.8/9/10-40.8 - 45.10-49.10
0187156 	2463583 2463583	M=20x1,5	330.35







SNODI SOSPENSIONI - SUSPENSION JOINTS

RIF. OCAP OCAP REF.	RIF. ORIG O.E. NUMBER	NOTE REMARKS	MODELLO / DESCRIZIONE MODEL / DESCRIPTION
0407249 	500379801 500379801 500334713 500344888 500379802 500334714 500344887		MOD: 35S9/10/11/12/13/15 - 35C9/10/11/12/13/15 - 29L10/12 - (I RIF. ORIGINALI CORRISPONDONO AL BRACCIO COMPLETO) - (O.E. NUMBER REFERS TO THE COMPLETE CONTROL ARM)
0407250 	500334716 500334716 500334717		MOD: 35S9/10/11/12/13/15 - 35C9/10/11/12/13/15 - 29L10/12 - (I RIF. ORIGINALI CORRISPONDONO AL BRACCIO COMPLETO) - (O.E. NUMBER REFERS TO THE COMPLETE CONTROL ARM)









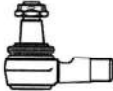
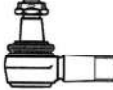

BRACCI OSCILLANTI - TRACK CONTROL ARMS

RIF. OCAP OCAP REF.	RIF. ORIG O.E. NUMBER	NOTE REMARKS	MODELLO / DESCRIZIONE MODEL / DESCRIPTION
0709422  A B	5801564293 5801564293		DAILY VI ANTERIORE - SUPERIORE FRONT - UPPER
0409422  A	5801564293 * 5801564293 *		
0909422  B	5801564281 5801564281 5801564274 5801564276	L=25,2 D=17 mm.	
0709423  A B	5801564316 5801564316		DAILY VI ANTERIORE - INFERIORE FRONT - LOWER
0409423  A	5801564316 * 5801564316 *		
0909422  B	5801564281 5801564281 5801564274 5801564276	L=25,2 D=17 mm.	
0787249  A B	500379802 500379802 42551297 500344888		DAILY III - IV - V ANTERIORE - SUPERIORE FRONT - UPPER
0797249  B A	500379801 500379801 42551296 500344887 500379802		DAILY III - IV - V ANTERIORE - SUPERIORE FRONT - UPPER
0407249  A	500379801 500379801 500334713 500344888 500379802 500334714 500344887	m=16x1,5 RHT D=43,95 mm.	

BRACCI OSCILLANTI - TRACK CONTROL ARMS

RIF. OCAP OCAP REF.	RIF. ORIG O.E. NUMBER	NOTE REMARKS	MODELLO / DESCRIZIONE MODEL / DESCRIPTION
1215953 B 	504039506 504039506		
0787250 A  B	500334716 500334716 500334486 42551289		DAILY III - IV - V ASSE ANTERIORE - INFERIORE FRONT AXLE - LOWER
0797250 B  A	500334717 500334717 500334487 42551290 500334716		DAILY III - IV - V ASSE ANTERIORE - INFERIORE FRONT AXLE - LOWER
0407250 A 	500334716 500334716 500334717	m=18x1,5 RHT D=44,95 mm.	
1215953 B 	504039506 504039506		
0903144 	504039506 * 504039506 *		DAILY III - IV - V ASSE ANTERIORE - FRONT AXLE









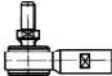
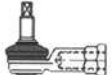

SNODI SOSPENSIONI - SUSPENSION JOINTS

RIF. OCAP OCAP REF.	RIF. ORIG O.E. NUMBER	NOTE REMARKS	MODELLO / DESCRIZIONE MODEL / DESCRIPTION
0187156 	2463583 2463583	M=20x1,5	330.35
0187157 	2460515 2460515	L=95	330.26/.30/.35H 330.30/.35HT
0280517 	93802209 93802209 93804060 500310933	L=72 m=18x1,5 RHT M=20x1,5 RHT	DAILY I-II-III-IV-V-VI
0286616 	500337201 500337201 8580735	L=80 m=18x1,5 RHT M=20x1,5 RHT	DAILY II - III
0400518 	93802242 93802242 93807545 93807320	m=18x1,5 RHT M=20x1,5 RHT	DAILY III - IV - V - VI
0407249 	500379801 500379801 500334713 500344888 500379802 500334714 500344887	m=16x1,5 RHT D=43,95 mm.	DAILY III - IV - V ANTERIORE - SUPERIORE FRONT - UPPER
0407250 	500334716 500334716 500334717	m=18x1,5 RHT D=44,95 mm.	DAILY III - IV - V ASSE ANTERIORE - INFERIORE FRONT AXLE - LOWER
0407893 	504212586 504212586 504212584	m=18x1,5 RHT M=20x1 RHT	DAILY III-IV-V-VI
0407894 	5801378064 5801378064	m=18x1,5 RHT M=20x1,5 RHT	DAILY III MOD. 90 Q.li
0409422 	5801564293 * 5801564293 *		DAILY VI SNODO SOSPENSIONE ASSE ANTERIORE - SUPERIORE BALL JOINT FRONT AXLE - UPPER
0409423 	5801564316 * 5801564316 *		DAILY VI SNODO SOSPENSIONE ASSE ANTERIORE - INFERIORE BALL JOINT FRONT AXLE - LOWER

STABILIZZATORI - STABILIZERS

RIF. OCAP OCAP REF.	RIF. ORIG O.E. NUMBER	NOTE REMARKS	MODELLO / DESCRIZIONE MODEL / DESCRIPTION
0507335 	98484091 98484091 98488013	L=100	490.18.29E2 - CITYCLASS: - 25-29-35 - 491.22/24/27 - 591.22/.27
0507165 	4741171 4741171	L=355	175.24 - TURBOSTAR: - 130.30/33/36/42/48 - 190.36/42/48 - TURBOTECH: - 190.32/36-220.32/36-240.36/48
0587871 	500383975 500383975		DAILY III ASSE ANTERIORE - FRONT AXLE
0597871 	500383976 500383976		DAILY III ASSE ANTERIORE - FRONT AXLE
0507552 	504092614 504092614	L=130 D1=20 D2=16,5	DAILY III-IV ASSE POSTERIORE - REAR AXLE
0507574 	504092613 504092613	L=130 D1=18 D2=16,5	DAILY III-IV ASSE POSTERIORE - REAR AXLE
0507893 	500336364 500336364	L=100 D1=20 D2=11	DAILY III-IV ASSE POSTERIORE - REAR AXLE

TESTE COMANDO CAMBIO - GEAR BOX CONTROL BALL JOINTS

RIF. OCAP OCAP REF.	RIF. ORIG O.E. NUMBER	NOTE REMARKS	MODELLO / DESCRIZIONE MODEL / DESCRIPTION
0287294 	42071290 42071290	L=35 M=10x1	EUROCARGO - TECTOR - EUROTRAKKER - EUROTRAKKER CURSER - EUROSTAR - EUROTECH - EUROMOVER
0287319 	42485639 42485639	L=55 M=10	175.24 - EUROCLASS.:29/.35/.HD - EURORIDER:./29/.35/.38 - TURBOSTAR:190.36/42/48 - 250.36/48-260.36/48 - TURBOTECH:190.30-220.36 - 240.36/48-260.36
0287229 	8198187 8198187	L=55 M=12x1,75 RH	175.24-175.24 RSU - 370.24/.30/.35 - EUROCARGO:95E21- 135E23 - EUROCLASS-EURORIDER - TURBOSTAR:190.24/.42/ .48 - 240.36/.48-260.48 - TURBOTECH:190.26-260.36
0297229 	8198188 8198188 42485638	L=55 M=12x1,75 LH	175.24-175.24 RSU - 370.24/.30/.35 - EUROCARGO:95E21- 135E23 - EUROCLASS-EURORIDER - TURBOSTAR:190.24/.42/ .48 - 240.36/.48-260.48 - TURBOTECH:190.26-260.36
0281786 	42041327 42041327 41002118 42079853 41203863	L=55 M=10x1,5 RH	190 - 260 - 300 - 320 - 330 - EUROCARGO - EUROFIRE - EUROSTAR - E.TECH CURSOR - EUROTRAKKER - TURBOTECH - STRALIS
0291786 	42041328 42041328 41002119 42079850 42079852 41203864	L=55 M=10x1,5 LH	190 - 260 - 300 - 320 - 330 - EUROCARGO - EUROFIRE - EUROSTAR - E.TECH CURSOR - EUROTRAKKER - TURBOTECH - STRALIS
0186949 	41005523 41005523	L=75 M=16x1,5 RH	EUROTRAKKER - EUROTECH: - 190E34/38
0187228 	8550139 8550139	L=85 M=14 x 1,5 RH	50-75 - 115.15/17 - 135.14/17
0187226 	8578493 8578493 8582313	L=85 M=14 x 1,5 RH	50.9-60.11- 65.9/.12 - 79.12-79.14 - Posteriore - Rear
0181785 	42042912 42042912 3435788 41218482	L=90 M=16x1,5 RH	EUROCARGO - EUROFIRE - EUROTECH - EUROTECH CURSOR - EUROTRAKKER - EUROTRAKKER CURSOR - EUROSTAR - EUROSTAR CURSOR - 19026H >330 - 30 AN - TECTOR RESTYLING -TURBOTECH
0187234 	8578492 8578492	L=90 M=16 x 1,5 RH	50.9-60.11-65.9/.12 - 79.12-79.14 - anteriore-front

TESTE COMANDO CAMBIO - GEAR BOX CONTROL BALL JOINTS

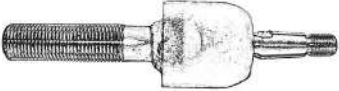
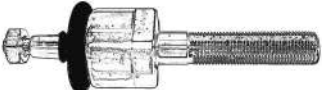
RIF. OCAP OCAP REF.	RIF. ORIG O.E. NUMBER	NOTE REMARKS	MODELLO / DESCRIZIONE MODEL / DESCRIPTION
0607254 	42072495 42072495	L=90 M=16 x 1,5 RH	190-26H > 330-36H - EHRENREICH
0607191 	41210795 41210795	L=100 M=16 x 1,5 RH	E. TRAKKER CURSOR: - 190E35 > 410E35 - EUROSTAR CURSOR: - 260E43 - EUROTECH CURSOR: - 440E39 > 440E43

KIT PERNO FUSO - KING PIN SET

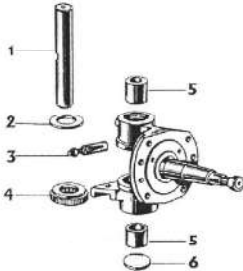
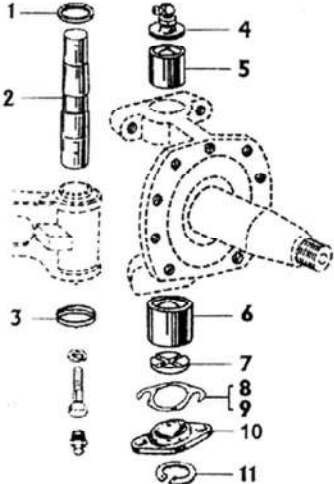
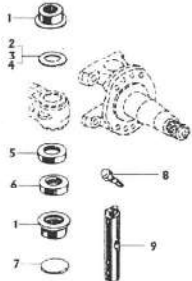
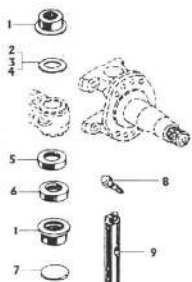
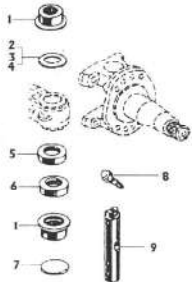
RIF. OCAP OCAP REF.	RIF. ORIG O.E. NUMBER	NOTE REMARKS	MODELLO / DESCRIZIONE MODEL / DESCRIPTION
0927364 	-	L=187 D=28,8	(KIT COMPLETO PER Nr. 2 RUOTE) - (KIT SUITABLE FOR Nr. 2 WHEELS) - - 50-60-65-70-75 NC - OM 50-55-65-70-75
0927365 	-	L=173 D=27/34	(KIT COMPLETO PER Nr. 2 RUOTE) - (KIT SUITABLE FOR Nr. 2 WHEELS) - - 50/55.8/F8.9/F9.10/F10 - 60.8/F8 - 60/65/70.10/F10 - 75/79.10/F10 - 79/80/90.13/F13 - 60.11 TURBO Z - 50/65.9Z - 65.12 TURBO Z
0927378 	-	L=220 D=40	(KIT COMPLETO PER Nr. 2 RUOTE) - (KIT SUITABLE FOR Nr. 2 WHEELS) - - 682-690-691-180
0927379 	-	L=220 D=40,1	(KIT COMPLETO PER Nr. 2 RUOTE) - (KIT SUITABLE FOR Nr. 2 WHEELS) - - 682-690-691-180
0927380 	-	L=220 D=40,3	(KIT COMPLETO PER Nr. 2 RUOTE) - (KIT SUITABLE FOR Nr. 2 WHEELS) - - 682-690-691-180



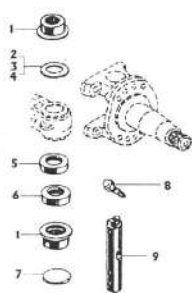
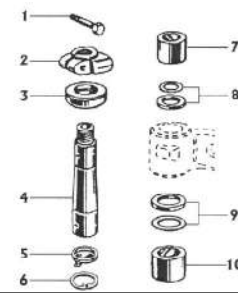
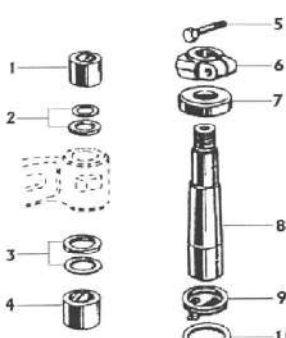
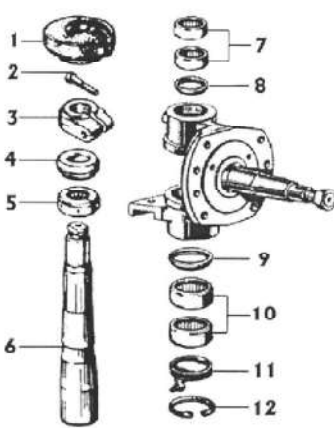



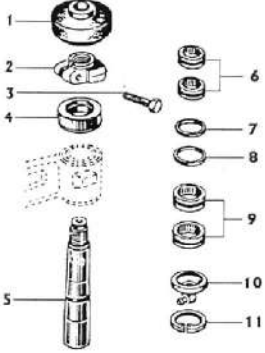
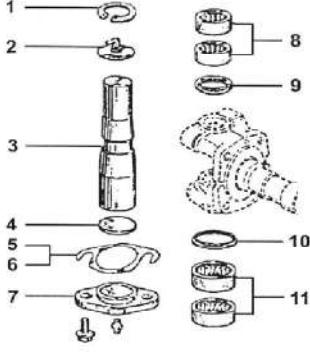
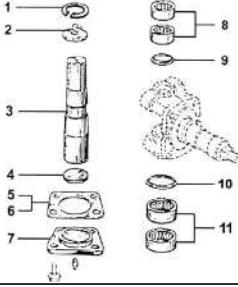
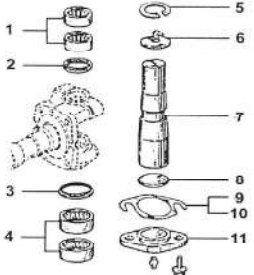

KIT PERNO FUSO - KING PIN SET

RIF. OCAP OCAP REF.	RIF. ORIG O.E. NUMBER	NOTE REMARKS	MODELLO / DESCRIZIONE MODEL / DESCRIPTION
0927381 	-	L=220 D=40,5	(KIT COMPLETO PER Nr. 2 RUOTE) - (KIT SUITABLE FOR Nr. 2 WHEELS) - - 682-690-691-180
0927382 	-	L=262 D=41/49,6	(KIT COMPLETO PER Nr. 2 RUOTE) - (KIT SUITABLE FOR Nr. 2 WHEELS) - - 160NC - 619N - 683N - 684N/NP - 693 N1
0927383 	-	L=266,5 D=41,2/50,8	(KIT COMPLETO PER Nr. 2 RUOTE) - (KIT SUITABLE FOR Nr. 2 WHEELS) - - 693N1 U.T. - 619N1/N1P - 697N/NP - 300PC/PT
0927387 	-	L=277,5 D=41,2/50,8	(KIT COMPLETO PER Nr. 2 RUOTE) - (KIT SUITABLE FOR Nr. 2 WHEELS) - - 180.24/.24T/.26 - 190i26/i26T/i35/i35T - 190.30/.30P/.30T/.30PT/.38/.38P/.38T/.38PT - 190.33/.36/.42/.48 TURBOSTAR - 220.38T/.38PT - 220F35T - 220.36PT - 240.30/.30P - 240.38/.38P - 240.36P - 159/175.17 - 165/175.24R/.24T





KIT PERNO FUSO - KING PIN SET

RIF. OCAP OCAP REF.	RIF. ORIG O.E. NUMBER	NOTE REMARKS	MODELLO / DESCRIZIONE MODEL / DESCRIPTION
0927388 	-	L=277,5 D=41,2/50,8	(KIT COMPLETO PER Nr. 2 RUOTE) - (KIT SUITABLE FOR Nr. 2 WHEELS) - - 330.26H/.26HT/.26N - 330.30H/.30HT - 330.35H/.35HT
0927391 	-	L=178 D=28/35	(KIT COMPLETO PER Nr. 2 RUOTE) - (KIT SUITABLE FOR Nr. 2 WHEELS) - - EUROCARGO: - 60/65E10/E12/E14 - 75E12/E14/E15 - 95E18 - 80/100E15/E18/E21 - 180E21
0927392 	-	L=227 D=43/53	(KIT COMPLETO PER Nr. 2 RUOTE) - (KIT SUITABLE FOR Nr. 2 WHEELS) - - EUROCARGO: - 150E15H/E18H - 170E15/E18/E23/E27 - 260E23KE/E27KE - EUROTECH - EUROSTAR - EUROTRAKKER
0927393 	-	L=199 D=35/43	(KIT COMPLETO PER Nr. 2 RUOTE) - (KIT SUITABLE FOR Nr. 2 WHEELS) - - EUROCARGO: - 120/130E15/E18/E23 - 150E15/E18/E23/E27 - 260E23 - 280E23 - 320E27



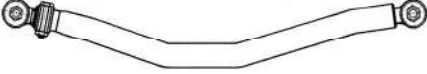
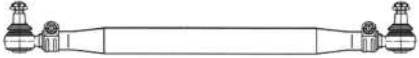

BARRE ACCOPPIAMENTO - TIE RODS

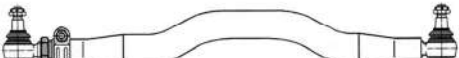
RIF. OCAP OCAP REF.	RIF. ORIG O.E. NUMBER	NOTE REMARKS	MODELLO / DESCRIZIONE MODEL / DESCRIPTION
0507819  0186424 M=30x1,5 RHT	81467106435 81467106435 81467106434	L=904	M 90
0507845  0186424 M=30x1,5 RHT	81467106438 81467106438 81467106439	L=1000	M 90: - 17.192-17.232-17.272-18.192 - 18.222-18.232-18.262-18.272
0507846  0186598 M=30x1,5 RHT	81467106442 81467106442 81467106443 81467106460	L=1005	M 90: - 17.192-17.232-17.272-18.192 - 18.222-18.232-18.262-18.272 - 24.192-24.222-24.232-24.262 - 24.272
0507816  0186613 M=28x1,5 RHT 0196613 M=28x1,5 LHT	81467106409 81467106409 81467106238 81467106410 81467106240 81467106242 81467106411	L=1430	G 90 - L 2000
0507405  0186424 M=30x1,5 RHT	81467116743 81467106926 81467116743 81467116744 81467116810 81467116884 81467116885	L=1450 T=50	L 2000-M 2000 L-M 2000 M-M 90-TGM
0507832  0186613 M=28x1,5 RHT	81467106325 81467106325 81467106086 81467107001	L=1525	520 H
0507848  0186598 M=30x1,5 RHT 0196598 M=30x1,5 LHT	81466106579 81466106579 81466106580 81466106583 81466106624 81466106640 81467116720	L=1530	F 90-F 2000 - M 2000 - TGA - TGS - TGX
0507534  0186424 M=30x1,5 RHT 0196424 M=30x1,5 LHT	81467106316 81467106316 81467106314 81467106315	L=1545 T=38	M 90 - M 2000 L

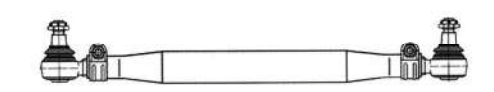

BARRE ACCOPPIAMENTO - TIE RODS

RIF. OCAP OCAP REF.	RIF. ORIG O.E. NUMBER	NOTE REMARKS	MODELLO / DESCRIZIONE MODEL / DESCRIPTION
<p>0507833</p>  <p>0186599 M=38x1,5 RHT</p>	<p>81467106937 81467106937 81467106118 81467106162 81467106164 81467106189 81467106368 81467106369 81467106394 81467106833 82467106016</p>	L=1585	F 90: - 35.302-35.322
<p>0507847</p>  <p>0186424 M=30x1,5 RHT 0196424 M=30x1,5 LHT</p>	<p>81467106393 81467106393 81467106388 81467106390 81467106189 81467106164 81467106394 81467106369 81467106368 814671406367 81467106118</p>	L=1585	M 90: - 17.192-17.232-17.272-18.192 - 18.222-18.232-18.262-18.272 - 24.192-24.222-24.232-24.262 - 24.272
<p>0507817</p>  <p>0186598 M=30x1,5 RHT</p>	<p>81467106912 81467106912 81467106122 81467106194 81467106195 81467106836 81467106378 81467106379 81467106380 81467106830</p>	L=1588	F 7-F 8 - F 90-F 2000 - M 90- M 2000 - TGA - TGM - TGS
<p>0507840</p>  <p>0186613 M=28x1,5 RHT 0196613 M=28x1,5 LHT</p>	<p>81467106852 81467106852 81467106851 81467106395 81467116719</p>	L=1620	L 2000-M 2000
<p>0509978</p>  <p>0187894 M=30x1,5 RHT</p>	<p>81467106966 81467106966</p>	L=1625	F 2000
<p>0507808</p>  <p>0186598 M=30x1,5 RHT</p>	<p>81467106904 81467106904 81467106816 81467106359 81467106360 81467106362 81467106265 81467106396 81467106397 81467106266 81467116724 81467106131</p>	L=1628	F 90 - UNTERFLUR - F 2000 - M 2000 - E 2000 - M 90 - UL -

















BARRE ACCOPPIAMENTO - TIE RODS

RIF. OCAP OCAP REF.	RIF. ORIG O.E. NUMBER	NOTE REMARKS	MODELLO / DESCRIZIONE MODEL / DESCRIPTION
0507814  0186613 M=28x1,5 RHT 0196613 M=28x1,5 LHT	81467116894 81467116803 81467116893 81467116894 81467116896	L=1632 T=36	L 2000 - M 2000 - TGL - TGM
0507841  0186595 M=24x1,5 RHT 0196595 M=24x1,5 LHT	81467106866 81467106866 81467106865 81467116717 81467116728	L=1645	L 2000: - 8.103-8.113-8.153-8.163 - 8.223-8.224-9.153-9.163 - 9.223-9.224 - TGA
0507843  0187843 M=30x1,5	81467116711 81467116711 81467106934 81467106933	L=1650	M 2000: - 14.163-14.224-14.264-14.284 - 15.163-15.224-15.264-25.284
0507807  0186598 M=30x1,5 RHT 0196598 M=30x1,5 LHT	81467106353 81467106353 81467106112 81467106354 81467106165 81467106163 81467106167 81467106198 81467106361 81467116725 81467106849 81467116820 81767106879	L=1652	F7/F8 - F 90 - F 2000 - M 90 - M 2000 - TGA - UNTERFLUR - TGS - TGX
0507581  0186598 M=30x1,5 RHT	81467116726 81467116726 81467106994	L=1664 T=50	E 2000 - F 2000
0507915  0187894 M=30x1,5 RHT	81467116773 81467116773 81467116858 81467116859 81467116860 81467116861 81467116863 81467116883 81467116921 81467116862 81467116920 81467116848 81467116888 81467116930 81467116882	L=1679	TGA - TGX









BARRE ACCOPPIAMENTO - TIE RODS

RIF. OCAP OCAP REF.	RIF. ORIG O.E. NUMBER	NOTE REMARKS	MODELLO / DESCRIZIONE MODEL / DESCRIPTION
<p>0507835</p>  <p>0186598 M=30x1,5 RHT 0196598 M=30x1,5 LHT</p>	<p>81467106355 81467106355 81467106356 81467106373 81467106236 81467106267 81467106268 81467116723</p>	<p>L=1692</p>	<p>22.190</p>
<p>0509417</p>  <p>0186598 M=30x1,5 RHT 0196598 M=30x1,5 LHT</p>	<p>81467116933 81467116933 81467116966</p>	<p>L=1680 T=42</p>	<p>TGA - TGS - TGX</p>

















TIRANTI LONGITUDINALI - DRAG LINKS

RIF. OCAP OCAP REF.	RIF. ORIG O.E. NUMBER	NOTE REMARKS	MODELLO / DESCRIZIONE MODEL / DESCRIPTION
0507958   0186598 M=30x1,5 RHT  0196598 M=30x1,5 LHT	81466116064 81466106159 81466106200 81466106275 81466106317 81466116064 81467106319 81467106280 81467106313	L=710 T=40	F 2000 - F 90
0507823   0186598 M=30x1,5 RHT  0196598 M=30x1,5 LHT	81466106798 81466106798 81466106578 81466106598 81466106876	L=755	F 90 - F 2000
0507818   0186613 M=28x1,5 RHT	81466106305 81466106305 81466106301 81466106328	L=785	G 90
0506436   0186595 M=24X1,5 RHT	81466106304 81466106304 81466106327 81466106329 81466106281 81466106300 81466106303	L=785 T=30	G 90
0507217   0186424 M=30x1,5 RHT	85461106141 85461106141 85466106105 85466106141 85466106205 85466106231 85466106005	L=795 T=38	M 2000 L - TGL
0506445   0186598 M=30X1,5 RHT	81466106288 81466106288 81466106088	L=800	423-532
0507844   0186598 M=30x1,5 RHT	81466106167 81466106167	L=805	16.28HA-16321HA (4x4) - 1928HA-1932HA (4x4)







TIRANTI LONGITUDINALI - DRAG LINKS

RIF. OCAP OCAP REF.	RIF. ORIG O.E. NUMBER	NOTE REMARKS	MODELLO / DESCRIZIONE MODEL / DESCRIPTION
<p>0506444</p>  <p>0186598 M=30x1,5 RHT</p>	<p>81466106280 81466106280</p>	L=815	16.280-19.240-19.280 - 20.281-22.280-26.280 - 32.280
<p>0509968</p>  <p>0186613 M=28x1,5 RHT</p>	85466106162	L=820	
<p>0507839</p>  <p>0186613 M=28x1,5 RHT</p>	<p>81466106754 81466106754 81466106753 85466106104 81466106006 81466106004 85466106031 85466106230</p>	L=825	L 2000: - 8.103-8.113-8.153 - 8.163-8.223-8.224 - 9.183-9.163-9.223 - 9.224
<p>0506446</p>  <p>0186595 M=24x1,5 RHT</p>	<p>81466106725 81466106725 85466106201 85466106030 81466106001 81466106724 85466106102</p>	L=826	L 2000
<p>0507842</p>  <p>0186424 M=30x1,5 RHT</p>	<p>85466106012 85466106012 85466106142 85466106212 85466106112</p>	L=840	M 2000: - 14.163-14.224-14.264-14.284 - 15.163-15.224-15.264-25.284
<p>0507533</p>  <p>0186613 M=28x1,5 RHT</p>	<p>85466106140 85466106140 85466106021 85466106121</p>	L=840 T=38	L 200 - M 2000 L - TGL
<p>0507821</p>  <p>0186598 M=30x1,5 RHT</p>	<p>81466106160 81466106160</p>	L=848	33.320 (6x4)
<p>0507813</p>  <p>0186613 M=28x1,5 RHT</p>	<p>85466106247 85466106247</p>	L=853 T=38	TGL 8T

















TIRANTI LONGITUDINALI - DRAG LINKS

RIF. OCAP OCAP REF.	RIF. ORIG O.E. NUMBER	NOTE REMARKS	MODELLO / DESCRIZIONE MODEL / DESCRIPTION
0507559  0186598  M=30x1,5 RHT	85466106143 85466106143 85466106107 85466106007	L=860 T=42	M 2000 L
0507812  0186613  M=28x1,5 RHT	85466106246 85466106246 85466106160	L=864 T=38	TGL
0509969  0186424  M=30x1,5 RHT	85466106052 85466106052	L=875 T=38	2000 L - TGM
0509970  0186598  M=30x1,5 RHT	85466106156 85466106156	L=882 T=38	M 2000 L - L 2000 - CLA
0509971  0186598  M=30x1,5 RHT	85466106163 85466106163		TGM
0507537  0186598  M=30x1,5 RHT	85466106144 85466106144 85466106108 85466106208	L=896 T=38	M 2000 L
0509973  0186598  M=30x1,5 RHT	81466106767	L=900	F 2000
0507215  0186424  M=30x1,5 RHT	85466106219 85466106019 85466106119 85466106150 85466106219	L=910 T=40	M 2000 M







TIRANTI LONGITUDINALI - DRAG LINKS

RIF. OCAP OCAP REF.	RIF. ORIG O.E. NUMBER	NOTE REMARKS	MODELLO / DESCRIZIONE MODEL / DESCRIPTION
<p>0507214</p>  <p>0186424 M=30x1,5 RHT</p>	<p>81466106241 81466106241 81466106414</p>	<p>L=940 T=40</p>	<p>14.170/192</p>
<p>0507216</p>  <p>0186424 M=30x1,5 RHT</p>	<p>81467106437 81467106436 81467106437 81467106455</p>	<p>L=955 T=40</p>	<p>M 90</p>
<p>0507815</p>  <p>0186424 M=30x1,5 RHT</p>	<p>85466106151 81466106692 81466106693 81466106695 85466106020 85466106151</p>	<p>L=960 T=42</p>	<p>M 2000 M - M 90</p>
<p>0507408</p>  <p>0186598 M=30x1,5 RHT</p>	<p>81466116199 81466106809 81466106810 81466106823 81466106838 81466106839 81466116104 81466116105 81466116107 81466116134 81466116135 81466116137 81466116199 81466116200 81466116206</p>	<p>L=967 T=52</p>	<p>TGA-TGS-TGX</p>
<p>0507956</p>  <p>0186598 M=30x1,5 RHT</p>	<p>85466106152 85466106018 85466106118 85466106152 85466106218 85466106235</p>	<p>L=980 T=42</p>	<p>M 2000 M</p>
<p>0507917</p>  <p>0186758 M=30x1,5 RHT</p>	<p>81466106836 81466106836 81466116133 81466116197 81466116198 81466116132 81466116097 81466116096 81466106808 81466106807 81466116099 81466116136 81466116205</p>	<p>L=993</p>	<p>TGA - TGS - TGX</p>









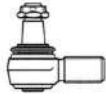

TIRANTI LONGITUDINALI - DRAG LINKS

RIF. OCAP OCAP REF.	RIF. ORIG O.E. NUMBER	NOTE REMARKS	MODELLO / DESCRIZIONE MODEL / DESCRIPTION
0507953  0186598  M=30x1,5 RHT	85466106153 85466106153 85466106126 85466106226 85466106026	L=1000 T=42	M 2000 M
0507951  0186598  M=30x1,5 RHT 0186758  M30x1,5 RHT	81466116201 81466106840 81466116201 81466116202 81466116138 81466116139 81998051662 81466116145 81466116203 81466106811 81466106812	L=1021 T=52	TGA - TGS
0509975  0186424  M=30x1,5 RHT	81466106661 81466106661	L=1030 T=42	F90 UNTERFLUR
0506443  0186442  M=30x1,5 RHT	81466106721 81466106721 81466106333 81466106334 81466106354 81466106355 81466106360 81466106361 81466106722 81466106723	L=1040	F 7/8 - F 90 - UNTERFLUR - F2000
0507955  0186598  M=30x1,5 RHT 0196598  M30x1,5 LHT	81466116201 81466106374 81466116019 82466106080 82466106189 82466106190	L=1050 T=42	E 2000 - F 2000
0509976  0186598  M=30x1,5 RHT	81466106691 81466106691	L=1060 T=52	
0507822  0186442  M=30x1,5 RHT	81466106779 81466106779 81466106780 81466106782	L=1060	F 2000





TIRANTI LONGITUDINALI - DRAG LINKS

RIF. OCAP OCAP REF.	RIF. ORIG O.E. NUMBER	NOTE REMARKS	MODELLO / DESCRIZIONE MODEL / DESCRIPTION
<p>0507409</p>  <p>0186598 M=30x1,5 RHT</p>	<p>81466116004 81466116004 81466116003 81466116005</p>	<p>L=1063 T=42</p>	<p>F 2000 - E 2000</p>
<p>0507406</p>  <p>0186598 M=30x1,5 RHT</p>	<p>81466106656 81466116006 81466106669 81466106659 81466106656</p>	<p>L=1070 T=48</p>	<p>F 2000 - F 90</p>
<p>0507810</p>  <p>0186598 M=30x1,5 RHT</p>	<p>81466106603 81466106603</p>	<p>L=1735 T=50</p>	<p>F 90</p>
<p>0507820</p> 	<p>81466106790 81466106790 81466106791 8246610691 82466106191</p>	<p>L=1749</p>	<p>F 2000</p>
<p>0509981</p> 	<p>81467106418 81467106418</p>	<p>L=1795 T=50</p>	<p>F 90</p>
<p>0509982</p> 	<p>81466116161 81466116161</p>	<p>L=1800 T=62</p>	<p>TGA - TGS</p>
<p>0509415</p>  <p>0186598 M=30x1,5 RHT</p>	<p>81466106813 81466106813 81466116204 81466116146 81466116147 81466116148</p>	<p>L=960 T=50</p>	<p>TGA - TGS</p>









TESTE STERZO - TIE RODS END

RIF. OCAP OCAP REF.	RIF. ORIG O.E. NUMBER	NOTE REMARKS	MODELLO / DESCRIZIONE MODEL / DESCRIPTION
0187838 	81953016096 81953016096	L=75 M=26x1,5 RHT	
0287361 	81953016280 81953016280 82953010010	L=75 M=26x1,5 RHT	F 2000 - TGA
0289962 	81953010040 81953010040	L=80 M=22x1,5 RHT	F90
0287906 	42533102 42533102 81953016219 81953016225 81953016226 81953016267 81953016291	L=80 M=26x1,5 RHT	F 90 - F 2000 - E 2000
0287360 	82953016016 82953016016 81953016337 81953016281	L=90 M=26x1,5 RHT	F 2000
0289923 	81953016268 1271126 42538048 82953016019 81953016268 82953016018 3099128 3090291	L=90 M=36x1,5 RHT	E 2000 - TGA - TGS - TGX
0186595 	81953016142 81953016142 81953016134 81953016303 81953010077	L=95 M=24X1,5 RHT	G 90: 6.100-8.100 - L 2000: - 8.103-8.113-8.153-8.163 - 8.223-8.224-9.153-9.163 9.223-9.224 - TGL - TGA
0196595 	81953016141 81953016141 81953016304 81953010078	L=95 M=24X1,5 LHT	G 90: 6.100-8.100 - L 2000: - 8.103-8.113-8.153-8.163 - 8.223-8.224-9.153-9.163 9.223-9.224 - TGL
0287684 	81953016106 81953016106 81953016095 81953016071	L=95 M=26x1,5 RHT	15T GL - 27 T - 30T
0186613 	81953016060 81953016060 81953016135 81953016140 81953016249	L=105 M=28x1,5 RHT	G 90 - L 2000 - M 2000 - TGL - TGM





TESTE STERZO - TIE RODS END

RIF. OCAP OCAP REF.	RIF. ORIG O.E. NUMBER	NOTE REMARKS	MODELLO / DESCRIZIONE MODEL / DESCRIPTION
0196613 	81953010079 81953010079 81953016139 81953016222	L=105 M=28x1,5 LHT	G 90 - L 2000 - M 2000 - TGL - TGM
0186424 	81953016239 81953016239 81953016250 81953010064 81953016162 81953010014 81953010067 81953016067 90804153111 81953016246	L=115 M=30x1,5 RHT	F7-F8 - F 90 - F 2000 - G 90 - M 90 - TGM - TGL - L 2000-M 2000-F 2000
0196424 	81953010074 81953010074 81953010013 81953016163 81953016068 90804153107 90804153113 81953010082	L=115 M=30x1,5 LHT	F7-F8 - F 90 - F 2000 - G 90 - M 90 - TGM - TGL
0186598 	81953016278 81953016234 81953016278 81953016242 81953016108 81953016112 81953010016 81953016048 81953016049 81953016053 81953016126 81953016090 81953016143 81953016149 81953016154 81953016156 81953016194 81953016274 81953016178 81953016224 81953010084	L=120 M=30x1,5 RH	F90-M90-L90 - F2000-M2000-L2000 - TGA-TGS-TGX - F8-F9







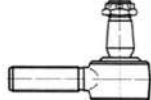

TESTE STERZO - TIE RODS END

RIF. OCAP OCAP REF.	RIF. ORIG O.E. NUMBER	NOTE REMARKS	MODELLO / DESCRIZIONE MODEL / DESCRIPTION
0196598 	81953016279 81953016237 81953016279 81953010015 81953010087 81953016030 81953016043 81953016050 81953016054 81953016087 81953016125 81953016091 81953016107 81953016120 81953016152 81953016155 81953016157 81953016168 81953016179 81953016275 81953016223	L=120 M=30x1,5 LH	F90-M90-L90 - F2000-M2000-L2000 - TGA-TGS-TGX - F8-F9
0187146 	90804154117 90804154117 81953010025	L=120 M=30x1,5 RHT	F 7-F 8
0197146 	81953016261 81953016261 81953016070	L=120 M=30x1,5 LHT	
0186599 	81953016184 81953016184 81953016276	L=120 M=38x1,5 RHT	F 90: - 35.302-35.322
0187463 	81953010091 81953010091	L=135 M= 38x1,5 RHT	
0186758 	81953010022 81953010022 0696226 0609643 0586714 0609634 0607073 1337367	L=135 M=30x1,5 RHT	F 90 - F 2000 - UNTERFLUR
0188994 	81953016286 81953016286	L=140 M=30x1,5 RHT	
0187783 	81953016236 81953016236	L=140 M=30x1,5 RHT	









TESTE STERZO - TIE RODS END

RIF. OCAP OCAP REF.	RIF. ORIG O.E. NUMBER	NOTE REMARKS	MODELLO / DESCRIZIONE MODEL / DESCRIPTION
0187843 	81953016270 81953016270	L=141 M=30x1,5 RHT	M 2000 - 14.163-14.224-14.264-14.284 - 15.163-15.224-15.264 - TGM
0187894 	81953016271 81953016271 81953016325	L=145 M=30x1,5 RHT	TGA - TGX
0187723 	81953016288 81.95301.6288 81953016288	L=150 M=30x1,5 RHT	M 2000 - TGA - TGS - TGX
0186442 	81953016263 81953016263	L=155 M=30x1,5 RH	F 90 - F 2000 - M 90 - UNTERFLUR
0187349 	81953016092 81953016092	L=160 M=38x1,5 RHT	
0197523 	81953016093 81953016093	L=160 M=38x1,5 LHT	





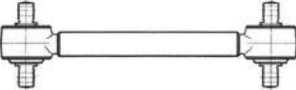

BARRE DI REAZIONE - TORQUE RODS

RIF. OCAP OCAP REF.	RIF. ORIG O.E. NUMBER	NOTE REMARKS	MODELLO / DESCRIZIONE MODEL / DESCRIPTION
0807820 	81432206247 81432206247 81432206341 81432206342	L=414 T=50 l=130 d=23	TGA - TGS - TGX
0907820 	81432206322 81432206322	l=130 p=30 D=72 d=23	
0807216 	81432306037 81432306037 81432309037	L=500 d=19	F7 - F8 - F 90 - F 2000
0907216 	81432306043 81432306043	l=130 p=30 D=65 d=19	
0807821 	81432206161 81432206161 81432206190	L=531 T=50 l=130 d=19	TGA - TGS - TGX
0907259 	81432206055 81432206055 81432206073 81432206107 81432206104	l=130 p=30 D=70 d=19	
0807848 	81432206216 81432206216	L=540	
0907405 	81432206202 81432206202	l=100 D=67 d=17	L 2000 - M 2000 L
0807214 	81432206052 81432206052 81432206010 81432206012 81432206013 81432206020 81432206035 81432206040 81432206041 81432206056 81432306018 81432306028	L=565 d=19	F7 - F8 - F90

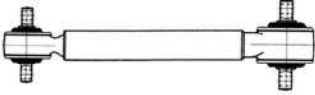



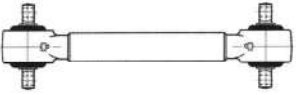

BARRE DI REAZIONE - TORQUE RODS

RIF. OCAP OCAP REF.	RIF. ORIG O.E. NUMBER	NOTE REMARKS	MODELLO / DESCRIZIONE MODEL / DESCRIPTION
0907259 A 	81432206055 81432206055 81432206073 81432206107 81432206104	l=130 p=30 D=70 d=19	
0807559 A  A	81432206129 81432206129 81432206097 81432206098 81432209129 81432306014 81432306030 81432206096 81432206137	L=571 d=19	M 90 - M 2000 - F 90
0907258 A 	81432206108 81432206108 81432206132	l=130 p=30 D=65 d=19	
0907757 A 	- -	D=65	senza perno (without pin)
0807407 A  A	81432206304 81432206382 81432206272 81432206305 81432209267 81432206267 81432206401 81432206236 81432209236 81432206304 81432209272	L=572 T=48 l=130 d=19	H - TGA - TGS - TGX
0907407 A 	85432206002 85.43220.6002 85432206002	l=130 D=74,9 d=19	
0807894 A  A	81432206268 81432206268	L=572 T=52	TGA - TGS - TGX
0907407 A 	85432206002 85.43220.6002 85432206002	l=130 D=74,9 d=19	
0807811 A  A	81432206067 81432206067 81432206068 81432206090 81432206092 81432209092	L=590 d=19	F 90 - F 2000 - TGA

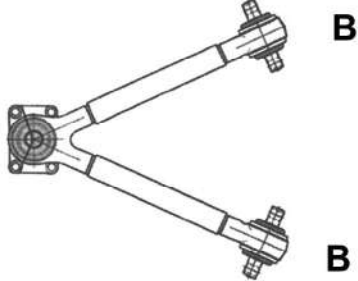

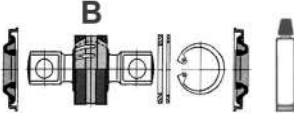
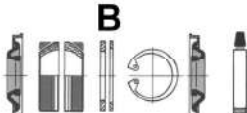



BARRE DI REAZIONE - TORQUE RODS

RIF. OCAP OCAP REF.	RIF. ORIG O.E. NUMBER	NOTE REMARKS	MODELLO / DESCRIZIONE MODEL / DESCRIPTION
0907259  A	81432206055 81432206055 81432206073 81432206107 81432206104	l=130 p=30 D=70 d=19	
0807824  A	81432206140 81432206140 81432209140	L=596 d2=18,5 d1=19	M 90: - 12.152-12.192-12.222-12.232 - 12.262-12.272-14.152- 14.162 - 14.192-14.222-14.232-14.262 - 14.272 - M 2000: - 14.163- 14.224-14.264-14.284 - 15.163-15.224-15.264-15.284
0907258  A	81432206108 81432206108 81432206132	l=130 p=30 D=65 d=19	
0907757  A	- -	D=65	senza perno (without pin)
0807906  A A	81432206196 81432206196 81432206232	L=596 d=19	TGA - TGS - TGX - F 2000
0907906  A	81432206250 81432206250	l=130 d=19	
0807809  A A	81432306031 81432306031		
0907216  A	81432306043 81432306043	l=130 p=30 D=65 d=19	
0807833  A A	81432206093 81432206070 81432206071 81432206072 81432206091 81432206093	L=620 T=58 l=130 d=19	F 90 - F 2000 - TGA - TGS - TGX







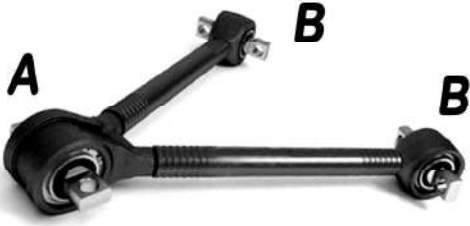

BARRE DI REAZIONE - TORQUE RODS

RIF. OCAP OCAP REF.	RIF. ORIG O.E. NUMBER	NOTE REMARKS	MODELLO / DESCRIZIONE MODEL / DESCRIPTION
0907919 	81432706119 81432706119 81432206241	D=75	
0807533 	81432706078 81432706078 81432706030 81432706034 81432706054 81432706055 81432706057 81432706074 81432706076 81432709054 81432709078	L=621 d=23	F 7 - F 8 - F 90 - F 2000 - M 90 - M 2000 - Unterflur
0907533 	81953016132 81953016132	L=61 IK=46 D=80	
0907534 	81953016133 81953016133	l=152 p=35 D=80 d=23	
0907722 	-	D=80	senza perno (without pin)
0809988 	81432706145	L=622	
0807907 	81432706117 81432706117	L=627 d=19	TGA - TGX
0907533 	81953016132 81953016132	L=61 IK=46 D=80	









BARRE DI REAZIONE - TORQUE RODS

RIF. OCAP OCAP REF.	RIF. ORIG O.E. NUMBER	NOTE REMARKS	MODELLO / DESCRIZIONE MODEL / DESCRIPTION
0907907 	81432706105 81432706105	l=130 p=24,3 d=25	
0807839 	81432706087 81432706087 81432706094 81432706088 81432706095	L=627 T=48	F 2000 - TGA - TGS - TGX
0907774 	81432706110 81432706110 0003502405 41272706 Z	l=152 p=24 D=80 d=25	
0907907 	81432706105 81432706105	l=130 p=24,3 d=25	
0807840 	81432706069 81432206221 81432706096 81432706114 81432706121	L=627 T=48	TGA - TGS - TGX
0907533 	81953016132 81953016132	L=61 IK=46 D=80	
0907840 	81432706126 81432706126 81432706123 81432706118	l=130 p=30 D=85 d=23	
0807841 	81432706137 81432706137 81432706116 81432706150 81432706151	L=627 T=48	F 2000 - TGA - TGS - TGX









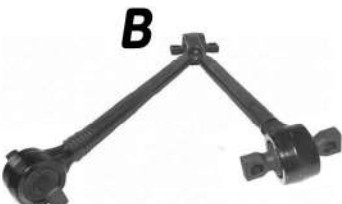

BARRE DI REAZIONE - TORQUE RODS

RIF. OCAP OCAP REF.	RIF. ORIG O.E. NUMBER	NOTE REMARKS	MODELLO / DESCRIZIONE MODEL / DESCRIPTION
0907774 A 	81432706110 81432706110 0003502405 41272706 Z	l=152 p=24 D=80 d=25	
0907907 B 	81432706105 81432706105	l=130 p=24,3 d=25	
0809989 A  B	85432706001 85432706001	L=627 T=48	
0907634 A 	1515191600 1515191600	l=152 p=24 D=70 d=25	
0907932 B 	81432706100 81432706100		
0807842 	81432706097 81432706097 81432706113 81432706135 81432706160 81432706161	L=627 T=46	F 2000 - TGA - TGS - TGX
0807807 A 	81432206174 81432206174	L=644 T=50	M 2000 L - M 2000 M
0907258 A 	81432206108 81432206108 81432206132	l=130 p=30 D=65 d=19	





BARRE DI REAZIONE - TORQUE RODS

RIF. OCAP OCAP REF.	RIF. ORIG O.E. NUMBER	NOTE REMARKS	MODELLO / DESCRIZIONE MODEL / DESCRIPTION
0807847 	81432706077 81432706055 81432706056 81432706075 81432706077 81432709056 81432706067 81432706068 81432706081	L=627 T=58	F 2000 - F 90
0907533 	81953016132 81953016132	L=61 IK=46 D=80	
0907686 	81432706079 81432706079 276192	l=152 p=24 D=80 d=23	
0807801 	81432206213 81432206213	L=660 T=38	M 2000 L - M 2000 M
0907339 	81432206213 81432206213	l=100 p=24 D=67 d=15	
0807846 	81432706053 81432706053 81432709053	L=693 T=46	M 2000 M - M 90
0907406 	81432706065 81.43270.6065 81432706065	D=65	
0907846 	81432706091 81432706091 1498132	l=115 p=24 D=75 d=19	









BARRE DI REAZIONE - TORQUE RODS

RIF. OCAP OCAP REF.	RIF. ORIG O.E. NUMBER	NOTE REMARKS	MODELLO / DESCRIZIONE MODEL / DESCRIPTION
0807951 	81432706102 81432706102		
0907907 	81432706105 81432706105	l=130 p=24,3 d=25	
0807810 	81432306039 81432306039 81432306038 81432309039 81991648156	L=755 d=19	
0907216 	81432306043 81432306043	l=130 p=30 D=65 d=19	
0807818 	81432206106 81432206082 81432206083 81432206084 81432206106 81432206147 81432306049	L=777 T=60 l=115 d=17	F 2000 - F 90 - M 2000 L - M 2000 M - M 90
0907528 	81432306051 81432306051 81432306068	l=115 p=24 D=62 d=17	
0807917 	81432506007 81432506007	L=840	
0907917 	81432506009 81432506009		
0807817 	81432206260 81432206222 81432206260 81432206283 81432206284	L=941 T=48 l=115 d=17	TGA - TGS - TGX
0907528 	81432306051 81432306051 81432306068	l=115 p=24 D=62 d=17	







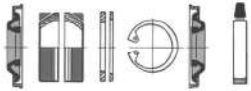

BARRE DI REAZIONE - TORQUE RODS

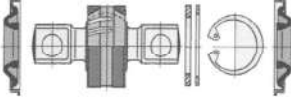
RIF. OCAP OCAP REF.	RIF. ORIG O.E. NUMBER	NOTE REMARKS	MODELLO / DESCRIZIONE MODEL / DESCRIPTION
0809420 	81432206327 81432206327 81432206271 81432206282 81432206314	L=572	TGA - TGS - TGX
0909992 	81432206285 81432206285	l=130 p=24 D=85 d=25	
0809446 	81432206270 81432206270	L=572 l=130 d=19	TGA - TGS - TGX
0907407 	85432206002 85.43220.6002 85432206002	l=130 D=74,9 d=19	









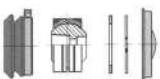

KIT DI SOSPENSIONE - SUSPENSION KITS

RIF. OCAP OCAP REF.	RIF. ORIG O.E. NUMBER	NOTE REMARKS	MODELLO / DESCRIZIONE MODEL / DESCRIPTION
0907230 	81432706089 81432706089	l=115	
0907919 	81432706119 81432706119 81432206241	D=75	E 2000 - F 2000 - F90 - TGA - TGS - TGX
0909990 	81432710027 81432710027		
0907757 	- -	D=65	M 90 - M 2000 - F 90
0907906 	81432206250 81432206250	l=130 d=19	TGA - TGS - TGX - F 2000
0907258 	81432206108 81432206108 81432206132	l=130 p=30 D=65 d=19	F 90 - M 90 - M 2000 L - M 2000 M
0907216 	81432306043 81432306043	l=130 p=30 D=65 d=19	F 7-F 8 - F 90-M 90-TGA-TGS-TGX
0907533 	81953016132 81953016132	L=61 IK=46 D=80	TGA - TGS - TGX - F 2000 - F 90
0907259 	81432206055 81432206055 81432206073 81432206107 81432206104	l=130 p=30 D=70 d=19	F7 - F8 - F90 - TGA - TGX
0907722 	-	D=80	F 7 - F 8 - F 90 - F 2000 - M 90 - M 2000 - senza perno (without pin)







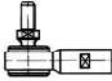

KIT DI SOSPENSIONE - SUSPENSION KITS

RIF. OCAP OCAP REF.	RIF. ORIG O.E. NUMBER	NOTE REMARKS	MODELLO / DESCRIZIONE MODEL / DESCRIPTION
0907330 	81432706045 81432706045 81432706040	l=152 p=24 D=80 d=21	Bus
0907534 	81953016133 81953016133	l=152 p=35 D=80 d=23	F 7 - F 8 - F 90 - F 2000 - M 90 - M 2000 - Unterflur
0907339 	81432206213 81432206213	l=100 p=24 D=67 d=15	M 2000L - M 2000 L
0907405 	81432206202 81432206202	l=100 D=67 d=17	L 2000 - M 2000 L
0907406 	81432706065 81.43270.6065 81432706065	D=65	F 90 - M 2000 L - M 2000 M
0907407 	85432206002 85.43220.6002 85432206002	l=130 D=74,9 d=19	TGA-TGS-TGX
0907907 	81432706105 81432706105	l=130 p=24,3 d=25	F 2000 - TGA - TGS - TGX
0907770 	81432506009 81432506009	L=60 D=40 d=20	G 90 - L 2000 - TGL
0907528 	81432306051 81432306051 81432306068	l=115 p=24 D=62 d=17	F 90-F 2000 - M 90-M 2000
0907846 	81432706091 81432706091 1498132	l=115 p=24 D=75 d=19	F 90 - M 2000 M - M 2000 F - M 90





KIT DI SOSPENSIONE - SUSPENSION KITS

RIF. OCAP OCAP REF.	RIF. ORIG O.E. NUMBER	NOTE REMARKS	MODELLO / DESCRIZIONE MODEL / DESCRIPTION
0907686 	81432706079 81432706079 276192	l=152 p=24 D=80 d=23	F90 - F2000 - TGA
0907683 	81432706080 81432706080	D=80 lK=46	F90 - F2000 - TGA
0907820 	81432206322 81432206322	l=130 p=30 D=72 d=23	TGA - TGS - TGX
0907774 	81432706110 81432706110 0003502405 41272706 Z	l=152 p=24 D=80 d=25	F 2000 - TGA - TGS - TGX
0907840 	81432706126 81432706126 81432706123 81432706118	l=130 p=30 D=85 d=23	TGA - TGS - TGX
0907932 	81432706100 81432706100		
0907917 	81432506009 81432506009		
0907634 	1515191600 1515191600	l=152 p=24 D=70 d=25	
0909993 	81964010152 81964010152		
0909994 	81432206241 81432206241		
0909992 	81432206285 81432206285	l=130 p=24 D=85 d=25	TGA - TGS - TGX





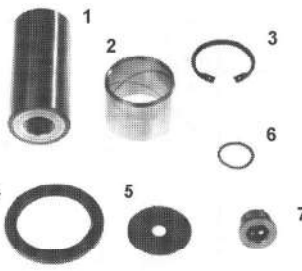

TESTE COMANDO CAMBIO - GEAR BOX CONTROL BALL JOINTS

RIF. OCAP OCAP REF.	RIF. ORIG O.E. NUMBER	NOTE REMARKS	MODELLO / DESCRIZIONE MODEL / DESCRIPTION
0287294 	90804105207 90804105207	L=35 M=10x1	TGS - TGX
0287229 	81953016173 81953016064 81953016130 81953016170 81953016173	L=55 M=12x1,75 RH	F 90 - F 2000 - G 90 - L 2000 - M 90 - M 2000 - TGA
0297229 	81953016174 81953016063 81953016131 81953016171 81953016174	L=55 M=12x1,75 LH	F 90 - F 2000 - G 90 - L 2000 - M 90 - M 2000 - TGA
0187228 	81953016266 81953010038 81953010045 81953016016 81953016169 81953016172 81953016176 81953016266 81953016235 81953016302	L=85 M=14 x 1,5 RH	F 90 - M 90 - M 2000 - Unterflur
0189963 	81953016127 81953016127	L=85 M=14 x 1,5 RHT	G 90
0189964 	81953016248 81953016248	L=85 M=14 x 1,5 LHT	
0189965 	81953016200 81953016200	L=115 M=14 x 1,5 RHT	F90-F2000-L2000-M90-M2000 L/M-FL6
0407247 	81953020043 81953020043		F90-L2000-M90



KIT PERNO FUSO - KING PIN SET

RIF. OCAP OCAP REF.	RIF. ORIG O.E. NUMBER	NOTE REMARKS	MODELLO / DESCRIZIONE MODEL / DESCRIPTION
<p>0927742</p> 	<p>81.44205.6016 81.44205.6016</p>	<p>L=174 D=34,5/35</p>	<p>G90</p>
<p>0927406</p> 	<p>81.44205.6009 81.44205.6009</p>	<p>L=213 D=44,5/45</p>	<p>M90</p>
<p>0927408</p> 	<p>81.44205.6013 81.44205.6013</p>	<p>L=223 D=49,5/50</p>	<p>F 2000 - F 90 - F 90 UNTERFLUR - M 2000 - M 90</p>
<p>0927409</p> 	<p>- -</p>	<p>L=109 D=50</p>	<p>F 90 - F 2000 - L 2000 - M 2000 - TGA - E 2000</p>
<p>0927410</p> 	<p>- -</p>	<p>L=119 D=50/64</p>	<p>F 2000 - F 90 - ASSE/AXLE: - V7 - 90L - VA7 - VAD7 - VA9 - E 2000 - L2000 - M2000 - TGA</p>









COMPONENTI - COMPONENTS

RIF. OCAP OCAP REF.	RIF. ORIG O.E. NUMBER	NOTE REMARKS	MODELLO / DESCRIZIONE MODEL / DESCRIPTION
1216318 	81960200286 81960200286		
1216302 	81437220062 81437220062		
1216303 	81437040074 81437040074		
1216304 	81962100450 81962100450		
1216305 	81437220063 81437220063		
1216306 	81437040077 81437040077		
1216319 	81437220059 81437220059		
1216329 	81437040057 81437040057		
1216330 	81437220019 81437220019		
1216331 	81432710046 81432710046		
1216333 	81437040061 81437040061		
1216334 	81432710081 81432710081		







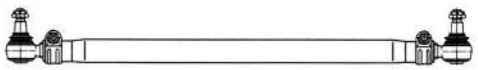

COMPONENTI - COMPONENTS

RIF. OCAP OCAP REF.	RIF. ORIG O.E. NUMBER	NOTE REMARKS	MODELLO / DESCRIZIONE MODEL / DESCRIPTION
1214293 	81962100278 81962100278		
1214294 	81437040029 81437040029		
1214295 	81437040025 81437040025		







BARRE ACCOPPIAMENTO - TIE RODS

RIF. OCAP OCAP REF.	RIF. ORIG O.E. NUMBER	NOTE REMARKS	MODELLO / DESCRIZIONE MODEL / DESCRIPTION
0507618  0186424 M=30x1,5 RHT	4243300303 4243300303 4243300503	L=1170 T=46	UNIMOG: U 1000-U 1200-U 1250-U 1400 - U 1450-U 1550
0507610  0186424 M=30x1,5 RHT 0196424 M=30x1,5 LHT	3913301003 3913300603 3913300803 3913301003 3913301203	L=1190 T=40	NG - SK - MK
0507636  0186424 M=30x1,5 RHT	4373300403 4253300003 4373300003 4373300403	L=1315 T=50	UNIMOG: U 1300-U 1500-U 1700-U 1750 - U 1800-U 1850-U 2100-U 2150 - U 2400-U 2450-U5000
0508964  0186598 M=30x1,5 RHT	3463304003	L=1438 T=58	ACTROS - ATEGO - AXOR - AXOR 2 - ACTROS MP2/MP3 - SK
0507786  0186595 M=24x1,5 RHT 0196595 M=24x1,5 LHT	3163300603 3163300603 3163300203 3163300503 3163300703	L=1454	LP LP: 608-709-809-811-813-913 - LPL: 608-709-809-813-913 - LP LPK: 608-709-808-809-813-913 - LP LPKF: 608-709-808 - LP LPS: 608-709-811-813-913 - LPLS: 608-709-813
0507651  0186551 M=30x1,5 RHT 0196961 M=30x1,5 LHT	9453300503 9453300503 9453300203 9453300303	L=1465	ACTROS - ACTROS MP2 - MP3 - ATEGO - ATEGO II - AXOR - AXOR 2 - ECONIC
0507792  0186424 M=30x1,5 RHT 0196424 M=30x1,5 LHT	6763300803 6763300803 6763301003 6763300503 6763300303	L=1546	LK/LN2: - 814F/L/S-817F/L/S/S-914/K/KO-917/K/KO - 1114/KL/S- 1117/KLS/S-1120/F/L/S/S - 1124/F-1317/KLS
0507647  0186598 M=30x1,5 RHT 0196598 M=30x1,5 LHT	3433300303 3433300303 3433300403 3433300103	L=1550	ATEGO I/II 2628 - ECONIC 2628 - L/LK/LK: 1621-1924 - LK/LS: 2624 (6x4)-LA: 2624 (6x6) - L/LK: 2628 (6x4) - MK: 1824 - 1827 - NG: 1626-1632-1622-1628-1719-1919 - 1926-1932-2026-2032- 2226-2232-2626 - 2632





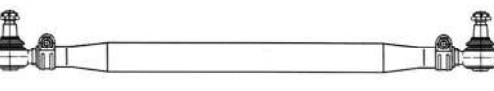

BARRE ACCOPPIAMENTO - TIE RODS

RIF. OCAP OCAP REF.	RIF. ORIG O.E. NUMBER	NOTE REMARKS	MODELLO / DESCRIZIONE MODEL / DESCRIPTION
<p>0507790</p>  <p>0186613 M=28x1,5 RHT 0196613 M=28x1,5 LHT</p>	<p>6763300703 6763300703 6763300203 6763300403 6763300603 6763300903</p>	L=1550	ATEGO I: 817 - LK/LN2: - 709/K-711-809/K-811/K-814/F/K/L/S - 817/F/K/L/L/S/S-914/K/KO-917/K - 1117/L-1317/K
<p>0507788</p>  <p>0186424 M=30x1,5 RHT</p>	<p>6763301103 6763301103 6763300103 6763301203</p>	L=1555	709/K-809/K-814/F/L/K/S - 817F/L/S-914AK/K-917AF - 1114-1117A-1120
<p>0506586</p>  <p>0186424 M=30x1,5 RHT 0196424 M=30x1,5 LHT</p>	<p>6773300303 6773300303 6773300403</p>	L=1562	LK/LN2: 817/L/LO-1114/K - 1117/L/LO/K/S-1120/F - 1124/F-1314/K/KO-1317/K/KO/LS - 1320/L-1324/L-1514/K
<p>0508967</p>  <p>0186551 M=30x1,5 RHT 0196961 M=30x1,5 LHT</p>	<p>6253302003 6253302003</p>	L=1565 T=50	
<p>0507910</p>  <p>0187467 M=38x1,5 RHT</p>	<p>6253301203 6253301203 6253300903 9443300203</p>	L=1588 T=60	ACTROS 1996 > - ACTROS MP2 / MP3-MP3 - AXOR 2 - NG - SK
<p>0507969</p>  <p>0186599 M=30x1,5 RHT</p>	<p>9443300503 9443300503 9443301303</p>	L=1588 T=60	ACTROS - ACTROS MP2/MP3 - ATEGO - AXOR 2 - SK
<p>0507669</p>  <p>0186599 M=30x1,5 RHT</p>	<p>3463304903 3463303903 3463304903 6253303203 9443301703</p>	L=1588 T=58	ACTROS - ACTROS MP2/MP3 - ATEGO - AXOR 2 - NG - SK
<p>0507437</p>  <p>0186598 M=30x1,5 RHT</p>	<p>6253303203 6253303203 9443301703 3463303903 3463304903</p>	L=1588 T=58	ACTROS - ACTROS MP2 / MP3 - ATEGO - AXOR 2

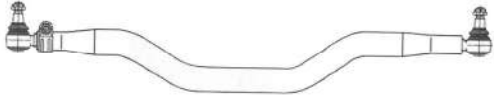



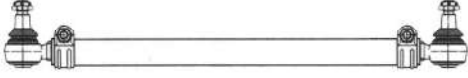

BARRE ACCOPPIAMENTO - TIE RODS

RIF. OCAP OCAP REF.	RIF. ORIG O.E. NUMBER	NOTE REMARKS	MODELLO / DESCRIZIONE MODEL / DESCRIPTION
0507653  0186612 M=24x1,5 RHT 0196612 M=24x1,5 LHT	6703300203 6703300203 6703300303 6703300103 6703300003 6703300403 6703300503	L=1594	T2/LN1 (507 D > 510) - VARIO: 512 D > 818 D (667 - 668 - 670)
0507436  0186551 M=30x1,5 RHT 0196961 M=30x1,5 LHT	9493301703 9493301003 9493301103 9493301703	L=1596 T=50	ACTROS - ACTROS MP2 / MP3 - AXOR
0501499  0180727 M=20x1,5 RHT 0190727 M=20x1,5 LHT	6673300603 6673300603	L=1600	T2/LN1 (507 D > 510) - VARIO: 512 D > 818 D (667 - 668 - 670)
0507975  0186598 M=30x1,5 RHT 0196598 M=30x1,5 LHT	9753302503 9753300203 9753300303 9753300803 9753301703 9753302503	L=1607 T=40	ATEGO - ATEGO 2
0507657  0186424 M=30x1,5 RHT 0196424 M=30x1,5 LHT	3853301403 3853301403 3853300503 3853301503 3853301103 3853300603	L=1611	380-381 - 383/385 - 617/651 - MK - NG
0507795  0186598 M=30x1,5 RHT 0196598 M=30x1,5 LHT	6173300203 6173300203 6173300303	L=1611	LK/LN2:1520/L-1524/L - MK:1417/K-1420/L/LS-1422/F/LS/S - 1424L-1426LS/S-1717K/L-1720/L/S - 1722/K/L/S-1820/L-2433/L-2534/L - NG:1414/K-1417/C/CK-1419/C/CL - 1420/L/LS-1422/L/LS/S-1425/LS/S - 1614K-1617/C/CK/CL/CS-1619/C/CC - 1622/K/L/S
0507591  0186551 M=30x1,5 RHT 0196961 M=30x1,5 LHT	6253302403 6253302403 6253302503 6253301503 6253301603 9493300903 9493300203 9423300803 9493300303	L=1615	ACTROS:3231B-3235B-3240B-3243B - ACTROS MP2 - MP3 - ATEGO II - AXOR II - MK - NG - SK
0507658  0186598 M=30x1,5 RHT 0196598 M=30x1,5 LHT	3933300303 3933300303 3933300003 3933300403 3933300203 3503307203	L=1620	371/385-387/389 - 393/397-398/616 - 617/619-620/621 - 623/624-645-659 - 1922 - 2044 - MK - NG: 1626-1632-1935 - SK: 1935 - LK - LN2 - SK - ACTROS - UNIMOG U52

BARRE ACCOPPIAMENTO - TIE RODS

RIF. OCAP OCAP REF.	RIF. ORIG O.E. NUMBER	NOTE REMARKS	MODELLO / DESCRIZIONE MODEL / DESCRIPTION
<p>0507655</p>  <p>0186613 M=28x1,5 RHT</p>	<p>3523302303 3523302303 3523301903 3523302003 3523302403 3523301603</p>	L=1626	352/353-358/360 - 387/389-395-621/624 - 649/655-656/659 - SK: 2629-3553
<p>0507793</p>  <p>0186424 M=30x1,5 RHT</p>	<p>3853301603 3853301603 3853300803 3853301803 3853300203</p>	L=1635	LK/LN2: 917/AK - MK:1222/AF-1224/AF - NG:1013/A/AF-1017/A/AF/AK/AK/AS - 1019AF-1213A/AK/AKO/AS-1217A/AK/AS - 1219/A/AF/AK-1222/A/AF-1225/AF - 1413/A/AK/AKO-1417/A/AKO/CA/CAK - 1419/AK/AS-1617AK/CAK-1619/AK - 1622/AK-1625/AK-1628/L
<p>0507218</p>  <p>0186598 M=30x1,5 RHT</p>	<p>3853302103 3853301303 3853302103 3853302203 3853302403</p>	L=1635 T=60	NG - LK/LN2 - MK
<p>0507605</p>  <p>0186613 M=28x1,5 RHT 0196613 M=28x1,5 LHT</p>	<p>3813300603 3813300503 3813300603 3813300303 3813300703 3583300103 3583300503</p>	L=1638 T=46	LK/LN2 - LP - NG
<p>0509391</p>  <p>0186424 M=30x1,5 RHT 0196424 M=30x1,5 LHT</p>	<p>9703300003 9703300003</p>	L=1640	ATEGO - ATEGO 2
<p>0507620</p>  <p>0186612 M=24x1,5 RHT 0196612 M=24x1,5 LHT</p>	<p>3583300703 3583300703 3273300103 3273300303 3273300403 3273300803</p>	L=1648	L/LS: 1113-1116 - LK/LP/LPK/LPS: 321 - LP: 911 - LPO: 344/1113
<p>0507979</p>  <p>0186551 M=30x1,5 RHT 0196961 M=30x1,5 LHT</p>	<p>9423302403 9423300403 9423301603 9423302403</p>	L=1664 T=50	ACTROS - ACTROS MP2/MP3 - ATEGO - AXOR 2







BARRE ACCOPPIAMENTO - TIE RODS

RIF. OCAP OCAP REF.	RIF. ORIG O.E. NUMBER	NOTE REMARKS	MODELLO / DESCRIZIONE MODEL / DESCRIPTION
0507886  0186551 M=30x1,5 RHT 0196961 M=30x1,5 LHT	9423300303 9423300303 9423300403 9423301603	L=1664 T=50	ACTROS - ACTROS MP2/MP3 - ATEGO - AXOR 2
0507593  0186598 M=30x1,5 RHT 0196598 M=30x1,5 LHT	6203300503 6203300503 6203300603 6203300003	L=1665	MK:1422F-1717L-1720/L-1722/L - 1726/L-1733L-1820/L-1827/L- 1831/L - 1834/L-2024L-2420-2422/L-2433/L - 2527L-2531L-2534/L - NG:1422/L-1617C/CL-1619C/CL-1620/L - 1622L-1625L-1628/L- 1633/L-1635/L - 1636L-1644-1928L-2219C/CL-2220/L - 2222L- 2228L-2233/L-2235L-2244/L - SK:1729/K/L-1735/5L-1748/8L/LS/ S - 1831/LS/S-1834L/LS-1838L/LS/S-1840/LS
0507603  0186551 M=30x1,5 RHT	9493300603 9493300603 9493300703 9493301503 9493301603 9493302003 9493302403	L=1687 T=52	ACTROS - ACTROS MP2 / MP3 - ATEGO - AXOR 2
0507604  0186551 M=30x1,5 RHT	9493300803 9493300403 9493300503 9493300803 9493301403 9493301903 9493302303	L=1700 T=52	ACTROS - ACTROS MP2 / MP3 - ATEGO - AXOR 2
0507643  0186551 M=30x1,5 RHT 0196961 M=30x1,5 LHT	9413300503 9413300103 9413300203 9413300303 9413300503	L=1735 T=50	ACTROS - ACTROS MP2/MP3 - ATEGO - AXOR - AXOR 2
0507916  0187916 M30x1,5 RHT	9453300003 9453300003 9453300103 9453300403 9453300603	L=1735 T=62	ACTROS - ACTROS MP2 - MP3
0507633  0186551 M=30x1,5 RHT	9423300203 9423300203 0014600005 0014600105 9423300003 9423300103 9423300703 9423302303 9423301103 9423301803 9423302003	L=1735	ACTROS - ACTROS MP2 - MP3 - ATEGO - AXOR I - AXOR II - ECONIC: 1823-2628-1828 - SK

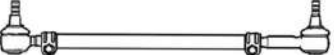







BARRE ACCOPPIAMENTO - TIE RODS

RIF. OCAP OCAP REF.	RIF. ORIG O.E. NUMBER	NOTE REMARKS	MODELLO / DESCRIZIONE MODEL / DESCRIPTION
<p>0509442</p> 	<p>9603300403 9603300403</p>	<p>L=1685 T=52</p>	<p>ACTROS MP4-MP5 ECONIC</p>

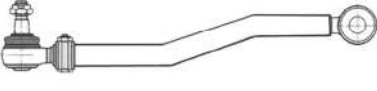













TIRANTI LONGITUDINALI - DRAG LINKS

RIF. OCAP OCAP REF.	RIF. ORIG O.E. NUMBER	NOTE REMARKS	MODELLO / DESCRIZIONE MODEL / DESCRIPTION
0508939 	9574600405 9574600405	L=387	
0502257  0180730 M=22x1,5 RHT 0190731 M=22x1,5 LHT	6014601505 6014601505 6014600505 6014600605 6014600705 6014600805 6014600905 6014601005 6014601105 6014601205 6014601305	L=450	T1: - 207D-208-209D-210 - 307D-308-309D-310 - 601-602 - T1/ TN: - 408-409-410
0500730  0180730 M=22x1,5 RHT	3094603105 6014600305 3094600305 3094602905 3094603005 3094603105 3094603205 6014600005 6014600105 6014600205	L=486	T1: 207-210-307 - T2/L: - 207-208-210-307-310 - 406-407-408- 409-410 - 508-608
0507659  0186613 M=28x1,5 RHT	6704602605 6704602605 6704602705	L=495	T2/LN1
0507624  0186613 M=28x1,5 RHT	6704602905 6704602805 6704602905	L=495 T=32	T2/LN1: 709-711-714-809-811-814
0507826  0187560 M=24x1,5 RHT	6684602405 6684602305 6684602405	L=495 T=28	T2/LN1 - VARIO
0507960  0187560 M=24x1,5 RHT	6684602105 6684602105 6684602205	L=495 T=28	T2/LN1 - VARIO









TIRANTI LONGITUDINALI - DRAG LINKS

RIF. OCAP OCAP REF.	RIF. ORIG O.E. NUMBER	NOTE REMARKS	MODELLO / DESCRIZIONE MODEL / DESCRIPTION
<p>0507608</p>  <p>0186613 M=28x1,5 RHT</p>	<p>6674601805 6674601605 6674601805</p>	<p>L=504 T=34</p>	<p>VARIO</p>
<p>0507660</p>  <p>0187560 M=24x1,5 RHT</p>	<p>6684601105 6684600905 6684600505 6684600705 6684601105</p>	<p>L=505</p>	<p>T2/LN1: 609/611/711/709</p>
<p>0507656</p>  <p>0187560 M=24x1,5 RHT</p>	<p>6684601705 6684601705 6684601905</p>	<p>L=505</p>	<p>T2/LN1 - MOD.: 609-611-668-669 - 709-711-714 - VARIO - MOD.: 512 D</p>
<p>0507898</p>  <p>0186613 M=28x1,5 RHT</p>	<p>6704602205 6704602205 6704601805 6704600905</p>	<p>L=505 T=32</p>	<p>T2/LN1: - 507 D - 507 DK - 508 D - 510 - 709 D - 709 DK - 711 D - 714 D - 809 D - 809DK - 811 D - 811 DK - 814 D</p>
<p>0507625</p>  <p>0186547 M=30x1,5 RHT</p>	<p>3164600805 3164600805 3164600605 3164600705 3164600905 3164800806</p>	<p>L=530</p>	<p>LK/LN2: 709-809-811 - LP LP:811-813 - LP LPK:813 - LP LPS 811-813 - LPLS: 813 - LPL:813 - NG: 1013</p>
<p>0507621</p> 	<p>3524606705 3524606705 3524602305 3524602405 3524606805</p>	<p>L=610</p>	<p>LA/LAS/LAK: - 1313-1314-1317</p>
<p>0508941</p> 	<p>0004604005 0004604005</p>	<p>L=650</p>	<p>MK-NG-SK</p>
<p>0507607</p> 	<p>3524607105 3524607105 3524603705 3524606605</p>	<p>L=655 T=36</p>	<p>-</p>
<p>0507662</p> 	<p>3524605505 3524605505 3524602905 3524604605 3524602105</p>	<p>L=668</p>	<p>352-353 - 358-360</p>







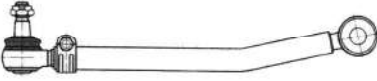

TIRANTI LONGITUDINALI - DRAG LINKS

RIF. OCAP OCAP REF.	RIF. ORIG O.E. NUMBER	NOTE REMARKS	MODELLO / DESCRIZIONE MODEL / DESCRIPTION
0507663 	3524605805 3524605805 3524603005 3524604705	L=668	352-353 - 358-360
0508943 	0004604305 0004604305	L=680 T=42	MK - NG - SK
0507971   0187971 M=30x1,5 RHT  0197971 M=30x1,5 LHT	0004606305 0004606005 0004606305	L=685 T=40	MK - NG - SK
0507661   0186424 M=30x1,5 RHT	3734600905 3734600905 3024600505 3024600605 3024603905 3024604005 3734600605	L=687	373 - O 302
0507440 	0024600605 0014605305 0024600605	L=708 T=40	ACTROS - ACTROS MP2 / MP3
0508944   0187146 M=30x1,5 RHT	6754601305 6754601305	L=709 T=40	
0507961 	0034603105 0014601105 0024600405 0034603105	L=711 T=42	ACTROS - ACTROS MP2/MP3 - ATEGO - AXOR - AXOR 2 - ECONIC
0506583   0186547 M=30x1,5 RHT	6734600605 6734600605 6734600205 6734600405 6734600805	L=725	LK/LN2:709-709K-711 - 809-809K-811-811K - 814/F/L/LO/O/S - 817/F/K/L/LO/LS/O/S - 914/K/O-917/K-1317K/S
0507828   0186547 M=30x1,5 RHT	6734600705 6734600305 6734600505 6734600705 6734600905	L=725 T=36	LK/LN2



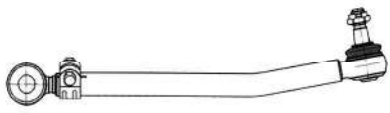





TIRANTI LONGITUDINALI - DRAG LINKS

RIF. OCAP OCAP REF.	RIF. ORIG O.E. NUMBER	NOTE REMARKS	MODELLO / DESCRIZIONE MODEL / DESCRIPTION
<p>0506581</p>  <p>0187146 M=30x1,5 RHT</p>	<p>6754602405 6754602405 6754601205 6754601805 6754603005 6754603305</p>	<p>L=727</p>	<p>914 - ATEGO I: 917 - 1217 - LK/LN2:817LO/S-917KO - 1114L/K/LO/O/S - 1117/L/LO/LS/K/O - 1120/L/LO/LS/O/S-1217KO - NG: 1217</p>
	<p>3914600605 3914600605</p>	<p>L=730</p>	
<p>0507587</p>  <p>0186551 M=30x1,5 RHT 0196961 M=30x1,5 LHT</p>	<p>0034603305 0014601505 0014607305 0034603305 3754601605</p>	<p>L=733 T=36</p>	<p>ACTROS - ACTROS MP2/MP3 - AXOR 2</p>
<p>0507617</p>  <p>0187959 M=30x1,5 RHT</p>	<p>4054600305 4054600005 4054600305 4054600605</p>	<p>L=753 T=42</p>	<p>UNIMOG U 300 - U 400</p>
<p>0507664</p>  <p>0186598 M=30x1,5 RHT</p>	<p>3434601405 3434601405 3434601205 3434601505 3434601005 3434600405 3434600805</p>	<p>L=760</p>	<p>MK: 2422/2522/2524/2527/L - ATEGO I: 2628 - ATEGO II: 2628 - ECONIC: 1624-1928-2628</p>
<p>0507698</p>  <p>0186598 M=30x1,5 RHT 0196598 M=30x1,5 LHT</p>	<p>6224600905 6224600905 6224601005 6224600205 6224600305</p>	<p>L=770</p>	<p>MK - NG</p>
<p>0507665</p>  <p>0187146 M=30x1,5 RHT</p>	<p>3464600005 3464600005 3464600105 3464605005 3354600005</p>	<p>L=770</p>	<p>LK/LN2 - NG</p>
<p>0507966</p>  <p>0186551 M=30x1,5 RHT 0196961 M=30x1,5 LHT</p>	<p>0034603505 0034603505 0014605705</p>	<p>L=773 T=36</p>	<p>ACTROS - ACTROS MP2/MP3</p>

















TIRANTI LONGITUDINALI - DRAG LINKS

RIF. OCAP OCAP REF.	RIF. ORIG O.E. NUMBER	NOTE REMARKS	MODELLO / DESCRIZIONE MODEL / DESCRIPTION
0507787  0187146 M=30x1,5 RHT	6754602605 6754602605 6754601405 6754602005 6754603205	L=777	LK/LN2: - 914-917-1114-1117-1120-1124
0508947  0187146 M=30x1,5 RHT	6744600405 6744600405	L=780	
0506576  0187146 M=30x1,5 RHT	6754602205 6754602205 6754601005 6754601605 6754602805	L=780	ATEGO: 1317 - 1514 - LK/LN2: - 914-1114-1114K-1117K/L/LO/LS/S - 1120-1120F/L/LS/S-1124F-1314-1314K - 1317-1317L/LS/S-1320-1320L/LS/S
0506577  0187146 M=30x1,5 RHT	6764601105 6764601105 6764600105 6764600605 6764601505	L=780	LK/LN2: - 1114K/L/S - 1117-1117K/L - 1120-1120F-1124F - 1314-1314K/KO - 1317-1317K/L/LS/S - 1320-1320K/L/LS/S/ UT - 1324-1324L/LS/S-1620
0507701  0187146 M=30x1,5 RHT	6764601205 6764601205 6764600205 6764600705 6764601605	L=780	LK/LN2: - 1120/F-1124/F - 1314/K/KO-1317/K/L/LS/S - 1320/L/LS/S-1324/L/LS/S
0507639  0187146 M=30x1,5 RHT	6764601905 6764601905 6764602105	L=783	LK/LN2: - 1314KO-1514/K/L - 1517/K/L-1520/L-1524/L
0507794  0186424 M=30x1,5 RHT	6764603105 6764603105	L=783	LK/LN2: - 1117-1314K/KO-1317K/KO/L/LS/S - 1320L/LS/S-1324L/LS/S-1514K/L - 1517K/L-1520/L-1524/L
0508948  0186598 M=30x1,5 RHT 0196598 M=30x1,5 LHT	6224600405 6224600405	L=820 T=50	







TIRANTI LONGITUDINALI - DRAG LINKS

RIF. OCAP OCAP REF.	RIF. ORIG O.E. NUMBER	NOTE REMARKS	MODELLO / DESCRIZIONE MODEL / DESCRIPTION
<p>0507970</p>  <p>0186598 M=30x1,5 RHT</p>	<p>0004601105 0004601005 0004601105</p>	<p>L=825 T=50</p>	<p>MK</p>
<p>0507978</p>  <p>0186551 M=30x1,5 RHT 0196961 M=30x1,5 LHT</p>	<p>0034603805 0034603805 0014606505</p>	<p>L=827 T=36</p>	<p>ACTROS - ACTROS MP2/MP3</p>
<p>0507439</p>  <p>0186424 M=30x1,5 RHT</p>	<p>9724601405 9724601405 9724601605</p>	<p>L=837 T=40</p>	<p>ATEGO - ATEGO 2</p>
<p>0507594</p>  <p>0186551 M=30x1,5 RHT</p>	<p>0014600305 0014600305 0014600405</p>	<p>L=840</p>	<p>MK: - 1424/L/LS/S-1427F-1720/L - 1733/L/LS/S-1820/L-1824/K/L - 1827/L/LS/S-1831/L/LS/S-1834/L/LS/S - 2433/L-2524/L-2531/L- 2534/L - SK:1722/1734/1735/1834/L</p>
<p>0506582</p>  <p>0186551 M=30x1,5 RHT</p>	<p>0014602905 0014602905 0014603005</p>	<p>L=840</p>	<p>MK - SK</p>
<p>0507613</p>  <p>0186424 M=30x1,5 RHT</p>	<p>9704600905 9704600905 9704600705</p>	<p>L=846 T=42</p>	<p>ATEGO - ATEGO 2</p>
<p>0508949</p>  <p>0186424 M=30x1,5 RHT</p>	<p>9704600805 9704600805</p>	<p>L=846 T=42</p>	<p>ATEGO - ATEGO 2</p>
<p>0507614</p>  <p>0187959 M=30x1,5 RHT</p>	<p>0034605705 0034605705 0024609605 0024609705</p>	<p>L=858 T=40</p>	<p>ACTROS - ACTROS MP2 / MP3 - AXOR 2</p>







TIRANTI LONGITUDINALI - DRAG LINKS

RIF. OCAP OCAP REF.	RIF. ORIG O.E. NUMBER	NOTE REMARKS	MODELLO / DESCRIZIONE MODEL / DESCRIPTION
0507695   0186551 M=30x1,5 RHT	0014602105 0014602105 0004602705 0014602205	L=860	MK: - 2433-2534
0507972   0186551 M=30x1,5 RHT	9574600705 9574600505 9574600705	L=860 T=50	ECONIC
0506578   0186598 M=30x1,5 RHT	6194605205 6194605205 6194602505 6194602905	L=860	ACTROS: 1831 - 1520-1625-1625S-1625L/LS-1628L - 2219C/ CL(6x2)-1826-2220C-2220L - 2222(6x2)6x4)-2225-2425-2828- 3025 - 3025K-3028-3228-1831
0507804   0186598 M=30x1,5 RHT	6194605305 6194605305 6194602705 6194603105 0014609705 6194601205	L=860	MK: 1424L/LS/S-1417F-1717K/L/S - 1720L-1722K/L/S-1726K/L/ LS/S - 1733L/LS-1820K/L-1824K/L-1827LS/L/S - 1831L/LS/S- 1834LS/S-2420L-2422B/K/L - 2426B-2433K/L-2524K/L-2527B/K/L - 2531L-2534K/L - NG:1614K-1617C/CK/CL/CS-1619C/CL - 1620L-1622K/L/S-1625K/L/LS/S-1628L - 2219C/CL-2220L-2222K/ L-2225B-2228L
0508950   0186551 M=30x1,5 RHT	0014602505 0014602505	L=860	MK
0507592   0186598 M=30x1,5 RHT	6174603405 6174603405 6174602405 6174602005	L=863	MK: - 1222A/AF/AK-1226AF-1227A - 1234AF-1417A/AK-1717/AK - 1722AK-1726AK-1820AK - 1824AK-2433-2433L - 2524-224L- 2531L-2534-2534L - NG:1222A-1222AF-1417CA/CAK - 1617CAK- 1622AK-1625AK
0508951   0186598 M=30x1,5 RHT	6204600505 6204600505	L=865	
0506580   0187146 M=30x1,5 RHT	3874604405 3874604405 3874600605 3874604505	L=865	NG: - 1626/LS/S-1632/LS/S-1719/S - 1919S-1926S-1932S- 2026(6x2) (6x4) - 2032(6x2)(6x4)-2226L/S(6x2)-2232LS(6x4) - 2626S/K(6x4)2632/S(6x4)-3332







TIRANTI LONGITUDINALI - DRAG LINKS

RIF. OCAP OCAP REF.	RIF. ORIG O.E. NUMBER	NOTE REMARKS	MODELLO / DESCRIZIONE MODEL / DESCRIPTION
<p>0506962</p>  <p>0186598 M=30x1,5 RHT</p>	<p>647460005 647460005 3874600705 6474600105 3874603305 3874601405 3874603205</p>	L=865	ACTROS
<p>0507671</p>  <p>0186598 M=30x1,5 RHT</p>	<p>3874603605 3874601505 3874603505 3874603605 6474600205 6474600305</p>	L=865 T=42	MK - NG - SK
<p>0508952</p>  <p>0186424 M=30x1,5 RHT</p>	<p>3854600805 3854600805</p>	L=865	NG
<p>0507590</p>  <p>0186598 M=30x1,5 RHT</p>	<p>6204602905 6204602905 6204603005</p>	L=865	ACTROS - ATEGO I/II - ECONIC - MK - NG - AK - AS
<p>0507632</p>  <p>0186598 M=30x1,5 RHT</p>	<p>0024606405 0024606405 0014609805 0014609905</p>	L=866	ACTROS - ACTROS MP2 - MP3 - ATEGO - AXOR - ECONIC: 2628
<p>0508953</p>  <p>0186551 M=30x1,5 RHT</p>	<p>0014600505 0014600505</p>	L=870 T=42	SK
<p>0507825</p>  <p>0187146 M=30x1,5 RHT</p>	<p>6174602905 6174600105 6174600305 6174602905</p>	L=870 T=42	NG







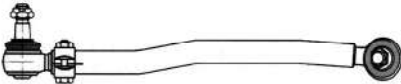





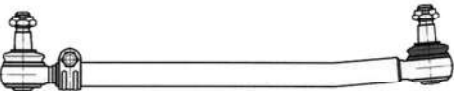

TIRANTI LONGITUDINALI - DRAG LINKS

RIF. OCAP OCAP REF.	RIF. ORIG O.E. NUMBER	NOTE REMARKS	MODELLO / DESCRIZIONE MODEL / DESCRIPTION
0507626  0187146 M=30x1,5 RHT	6174602805 6174602805 6174600005 6174600205	L=870	16.12-16.17-16.19-16.20-16.22 - MK: 1417-1420-1422 - NG: 1222-1417-1419-1420-1422-1425 - 1612-1919-1922
0508954  0186551 M=30x1,5 RHT	0004604505 0004604505	L=870 T=48	MK-NG-SK
0507666  0186598 M=30x1,5 RHT	6174603605 6174603505 6174603605	L=870	MK: 1420/LS-1722/AK/K/L/S - NG:1614/K-1617/CK/CS-1622/AK/K - 1625/AK/K/L/S/S
0507640  0186598 M=30x1,5 RHT	6254602505 6254602505	L=870	NG: - 1622/L-2222/L-2235/L-26287A-2635/A - 2636/AK-2644/S-3028/B/K-3336/AK/K - 3328/B/K-3535AK/K - SK: - 1729/K/L/LS-1735/K/L/LS-1748/L/LS/S - 1831/K/L/LS/S-1834/L/LS-1838/AK/K/L/LS - 1840/LS-1844/L/LS-1850/L/LS/S - 1853/AK/L/LS-1922/K/S-1929/A/AS/K/L/S - 1935/K/S-1948-2024/K-2031/K/S-2038/S - 2044/S-2050/S-2429/K/L/LS/S
0507629  0186598 M=30x1,5 RHT	0004609305 0004609305 0004609205 0014606905	L=873	ACTROS - ACTROS MP2 - MP3 - ATEGO - AXOR I/II:2535-2540-2543 - ECONIC: 1823-2628-1828 - MK-NG-SK
0508955  0186424 M=30x1,5 RHT	9724601005 9724601005	L=873 T=40	ATEGO - ATEGO 2
0508956  0186598 M=30x1,5 RHT	6174603205	L=875 T=42	AXOR - AXOR2 - NG



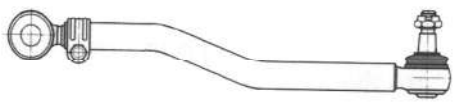

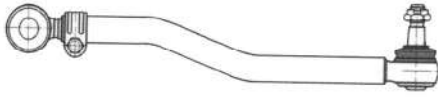



TIRANTI LONGITUDINALI - DRAG LINKS

RIF. OCAP OCAP REF.	RIF. ORIG O.E. NUMBER	NOTE REMARKS	MODELLO / DESCRIZIONE MODEL / DESCRIPTION
<p>0507631</p>  <p>0180730 M=22x1,5 RHT</p>	<p>0024604805 0024604805 0024604705 0034604905</p>	<p>L=876</p>	<p>ACTROS - MP2 - MP3 - ATEGO - AXOR: 2535-2540-2543 - AXOR 2 - ECONIC: 2628 - MK-N-G-SK</p>
<p>0507611</p>  <p>0186424 M=30x1,5 RHT</p>	<p>4274600005 4244600305 4274600005 4274600105 4274600305 4274600405</p>	<p>L=877 T=38</p>	<p>UNIMOG U 1000-U 1200-U 1250-U 1400 - U 1450-U 1550-U 1600- U 1650</p>
<p>0506585</p>  <p>0186598 M=30x1,5 RHT</p>	<p>0004607105 0004607105 0004607205 0014606705 0074607205</p>	<p>L=879</p>	<p>ACTROS - MP2 - MP3 - ATEGO I-II - AXOR I-II - ECONIC</p>
<p>0507630</p>  <p>0187789 M=28x1,5 RHT</p>	<p>0024604405 0024604405 0024604305 0034604805</p>	<p>L=879</p>	<p>ACTROS - ACTROS MP2 - MP3 - ATEGO - AXOR - AXOR II</p>
<p>0506579</p>  <p>0187146 M=30x1,5 RHT</p>	<p>3874604805 3874604805 3874600005 3874604905</p>	<p>L=880</p>	<p>NG:1626S-1632S-1719S-1919S-1926S - 1932S-2626S (6x4)- 1935-2226-2232 - 2626K (6x4)-2632-3332</p>
<p>0508957</p>  <p>0186551 M=30x1,5 RHT</p>	<p>0024608605</p>	<p>L=883 T=38</p>	<p>ACTROS - ACTROS MP2/MP3</p>
<p>0506575</p>  <p>0186598 M=30x1,5 RHT</p>	<p>6204602805 6204602805 6204600005 6204602005 6204603705 3933200632 3874600405 3874605005</p>	<p>L=885</p>	<p>ACTROS-ATEGO I-ATEGO II - ECONIC-NG-MK-SK</p>









TIRANTI LONGITUDINALI - DRAG LINKS

RIF. OCAP OCAP REF.	RIF. ORIG O.E. NUMBER	NOTE REMARKS	MODELLO / DESCRIZIONE MODEL / DESCRIPTION
0507912   0186551 M=30x1,5 RHT	0024605205 0024605205 0024605105 0034604005	L=885	ACTROS 1996 > - ACTROS MP2-MP3 - AXOR 2
0507805   0186598 M=30x1,5 RHT	6204603805 6204603805 6204600105 6204602105 6204603905	L=885	NG - SK - UNIMOG
0507973   0186598 M=30x1,5 RHT	0024607505 0024601705 0024607505 0024607605 0034604405 3754601705	L=886 T=38	ATEGO - AXOR 2
0507642   0187959 M=30x1,5 RHT	0034605805 0034601805 0034601905 0034605805	L=888 T=42	ACTROS MP2
0507968   0186598 M=30x1,5 RHT	0014600705 0014600705 0014600805 0014607005	L=888 T=38	ACTROS
0506963   0187146 M=30x1,5 RHT	3834604405 3834604405 3834601405 3834602305 3834600605	L=890	MK - ATEGO I - NG
0506584   0186547 M=30X1,5 RHT	3834604505 3834604505 3834601605 3834602405 3834600805	L=890	NG









TIRANTI LONGITUDINALI - DRAG LINKS

RIF. OCAP OCAP REF.	RIF. ORIG O.E. NUMBER	NOTE REMARKS	MODELLO / DESCRIZIONE MODEL / DESCRIPTION
<p>0507696</p>  <p>0187146 M=30x1,5 RHT</p>	<p>3834606605 3834606605 3834606705 3834602108 3834600705</p>	<p>L=890</p>	<p>NG: - 1625/K/L/LS/S</p>
<p>0507441</p>  <p>0186551 M=30x1,5 RHT</p>	<p>0014607405 0014604905 0014607405</p>	<p>L=893 T=42</p>	<p>ACTROS - ACTROS MP2 / MP3</p>
<p>0507887</p>  <p>0186598 M=30x1,5 RHT</p>	<p>0034604605 0034604605 3754600005 9744601005 9744601205</p>	<p>L=894 T=50</p>	<p>ATEGO - ATEGO 2</p>
<p>0507434</p>  <p>0186598 M=30x1,5 RHT</p>	<p>0034606005 0034606005 9724601905 9724602105</p>	<p>L=894 T=50</p>	<p>ATEGO - ATEGO 2</p>
<p>0507963</p>  <p>0186598 M=30x1,5 RHT</p>	<p>0034604705 0034604705 9744601105 9744601305 0034600705</p>	<p>L=894 T=50</p>	<p>ATEGO - ATEGO 2</p>
<p>0507615</p>  <p>0187959 M=30x1,5 RHT</p>	<p>0034605605 0024604905 0024605005 0034605605</p>	<p>L=895 T=40</p>	<p>ACTROS - ATEGO - AXOR - AXOR 2</p>
<p>0507827</p>  <p>0186598 M=30x1,5 RHT</p>	<p>9724602005 0034605905 9724601805 9724602005</p>	<p>L=895 T=50</p>	<p>ATEGO - ATEGO 2</p>
<p>0507789</p>  <p>0187789 M=28x1,5 RHT</p>	<p>0024604505 0024604505 0024604605 3754600405 0034605005</p>	<p>L=895</p>	<p>ACTROS-ACTROS MP2 - MP3 - ATEGO - AXOR - AXOR II</p>







TIRANTI LONGITUDINALI - DRAG LINKS

RIF. OCAP OCAP REF.	RIF. ORIG O.E. NUMBER	NOTE REMARKS	MODELLO / DESCRIZIONE MODEL / DESCRIPTION
0507627  0186598 M=30x1,5 RHT	0004609805 0004609805 0004609905	L=900	SK: - 1735/L-1748/L-1844/L-1850/L - 1853/L-1929/L-1948-2024-2031/S-2038/S - 2044/S-2050/S-2429/K/S-2435/S-2448/L/S - 2538/K/L/S/S-2544/L/S/S-2550/L/S - 2553/L/S-2629/B/K/S-2631/B/S-2635/K/S - 2638/K-2644/S-2628/K-2650/K
0507670  0186598 M=30x1,5 RHT	6204604105 6204602405 6204602605 6204604005 6204604105	L=900 T=48	NG - SK
0507967  0186551 M=30x1,5 RHT	0014607105 0004609505 0014607105	L=904 T=52	ACTROS - ACTROS MP2/MP3
0507829  0186551 M=30x1,5 RHT	0014604205 0014604205	L=905 T=48	SK
0507584  0186551 M=30x1,5 RHT	0024605405 0024605305 0024605405	L=905 T=38	ATEGO - AXOR 2
0508958  0187959 M=30x1,5 RHT	3754600605 3754600605	L=905 T=42	
0508959  0186598 M=30x1,5 RHT	0014605105 0014605105	L=905 T=42	
0507637  0187789 M=28x1,5 RHT	0034605105 0034605105 0024607705 0024607805	L=916 T=36	ATEGO - AXOR







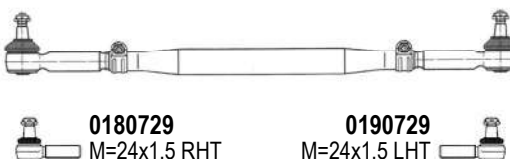

TIRANTI LONGITUDINALI - DRAG LINKS

RIF. OCAP OCAP REF.	RIF. ORIG O.E. NUMBER	NOTE REMARKS	MODELLO / DESCRIZIONE MODEL / DESCRIPTION
<p>0507965</p>  <p>0186551 M=30x1,5 RHT</p>	<p>0034604105 0024605905 0024606005 0034604105</p>	<p>L=935 T=38</p>	<p>ACTROS - ACTROS MP2/MP3</p>
<p>0507974</p>  <p>0186551 M=30x1,5 RHT</p>	<p>0034604505 0034604505 0024609305 0024609205</p>	<p>L=953 T=42</p>	<p>ACTROS - ACTROS MP2/MP3</p>
<p>0508960</p> 	<p>0014608605 0014608605</p>	<p>L=954 T=42</p>	
<p>0507962</p>  <p>0186551 M=30x1,5 RHT</p>	<p>0034604205 0024606105 0024606205 0034604205</p>	<p>L=958 T=38</p>	<p>ACTROS - ACTROS MP2/MP3 - ATEGO - AXOR 2</p>
<p>0508961</p> 	<p>3964603005 3964603005</p>	<p>L=975 T=42</p>	
<p>0507612</p>  <p>0186424 M=30x1,5 RHT</p>	<p>4274600005 4254600105 4254600205 4254600305 4254600405 4374600005 4374600105</p>	<p>L=995 T=38</p>	<p>UNIMOG U 1300-U 1350-U 1500-U 1550 - U 1700-U 1750-U 1800- U 1850 - U 2100-U 2150-U 2400-U 2450</p>
<p>0509479</p> 	<p>0034608005 0034608005 9604630815 A9604630815 A0034608005</p>	<p>L=999 T=42</p>	<p>AROCS 01.2013 -</p>
<p>0507976</p>  <p>0187342 M=24x1,5 RHT</p>	<p>4064600105 4064600105</p>	<p>L=1015 T=36</p>	<p>UNIMOG</p>
<p>0507964</p> 	<p>0034603405 0014605505 0034603405 0035603405</p>	<p>L=1057 T=40</p>	<p>ACTROS - ACTROS MP2/MP3</p>









TIRANTI LONGITUDINALI - DRAG LINKS

RIF. OCAP OCAP REF.	RIF. ORIG O.E. NUMBER	NOTE REMARKS	MODELLO / DESCRIZIONE MODEL / DESCRIPTION
0507911 	0014601305 0014601305 3754601505 0024600505 0014601405 0034603205	L=1095	ACTROS 1996 > - ACTROS MP2-MP3 - AXOR 2 - ATEGO
0507628 	0004604405 0004604405 6254605005	L=1115	MK: - 1717/L-1733/L-1834/L-2433/L-2531/L-2534/L - NG: - 2628/A- 2635-2636/K-2644/S-3028/K-3228/K - 3336/K-3535/AK - SK: - 1729K/LS/S-1735/K/LS/S-1748/L/LS/S - 1831/K/L/LS/S-1834/ L/LS/S-1834/L/LS/S - 1838/AK/K/L/LS/S-1840/LS-1844/L/LS/S - 1850/L/LS/S-1853/AK/L/LS/S-1922/K/S - 1929/A/AS/K/L/S-1935/ K/S-1948-2024/K
0507641 	0004606605 0004606605	L=1130	MK: - 1420/LS-1422/F/L-1424/LS/S-1717/L - 1720/L-1722/L-1726/ L/S-1733/L-1820/L - 1824/L-1824/L-1827/L-1831/L-1834/L - 2433/ L-2527/L-2531/L-2534/L - NG: - 1622/L-2222/L-2235/L-2635-2644/ S - SK: - 1729/K/L/LS/S-1735/L/LS/S-1748/L/LS/S - 1831/K/L/LS/ S-1834/L/LS/S - 1838/AK/K/L/LS/S-1840/LS-1844/L/LS/S - 1850/L/ LS/S-1853/AK/L/LS-1922/K
0508962 	0004604905 0004604905	L=1190 T=40	
0507694   0186551 M=30x1,5 RHT	0004604105 0004604105 0004605505 6254604205 6254607805 6994602405	L=1242	MK:1726/L-A831/L - NG: 3035B/K (8x4)- 3228B/K (8x4) - SK: 3229B/K (8x4)- 3233B/K (8x4) - 3234B/K (8x4)- 3534/K (8x4)
0508963 	0014608905 0014608905	L=1255 T=42	





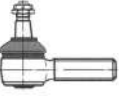



TIRANTI LONGITUDINALI - DRAG LINKS

RIF. OCAP OCAP REF.	RIF. ORIG O.E. NUMBER	NOTE REMARKS	MODELLO / DESCRIZIONE MODEL / DESCRIPTION
<p>0507652</p>  <p>0180729 M=24x1,5 RHT 0190729 M=24x1,5 LHT</p>	<p>3093301903 3093301903 3093301203 3093301403 3093301603 3093301703 3093301803 3093302003 3093302103 309331303</p>	<p>L=1476</p>	<p>T2/L: - 406DG-407D-408D/DG/G - 409G-410-508DG-608D</p>
<p>0508966</p> 	<p>0014609005 0014609005</p>	<p>L=1558 T=52</p>	
<p>0507697</p> 	<p>3914601705 3914601705 3914600905 3914601805</p>	<p>L=1826</p>	<p>MK: - 1733/LS/S-1834/LS/S-2433/LS/S - 2534/LS/S - NG: - 1325/ L-1628/L/LS/S-1633/LS/S-1635/LS/S - 2028/LS--2033/LS-2035/ LS-2036/LS-2225 - 2228/L - SK: - 1748/LS/S-1838/K/L-1844/LS/S- 1850/LS/S - 1853LS/S-1929A/AL/S-2429/LS/S-2435LS/S - 2448/ LS-2538/LS/S-2544/LS/S</p>
<p>0508971</p> 	<p>0014606105 0014606105</p>	<p>L=1863 T=42</p>	
<p>0507700</p> 	<p>6254601405 6254601405 6254604005 6254609605 6254609805 6994603705 6994603905 6994604005</p>	<p>L=1955</p>	<p>NG: - 1622/L-2225/B-2228/A - 3025/B/K-3228/B/K-3535/AK</p>
<p>0507977</p> 	<p>0034602905 4608505 24601005 34602905 0004608505 0024601005 0034602905</p>	<p>L=2069 T=42</p>	<p>ACTROS - ACTROS MP2/MP3</p>
<p>0509461</p>  <p>0186961 M=30x1,5 RHT</p>	<p>0024608805 0024608805 0024608905</p>	<p>L=761 T=38</p>	<p>ACTROS - ACTROS MP2 - MP3 AXOR 2</p>
<p>0509470</p>  <p>0187686 M=30x1,5 RHT</p>	<p>0034608605 0034608605</p>	<p>L=776 T=46</p>	<p>ACTROS MP4-MP5</p>







TESTE STERZO - TIE RODS END

RIF. OCAP OCAP REF.	RIF. ORIG O.E. NUMBER	NOTE REMARKS	MODELLO / DESCRIZIONE MODEL / DESCRIPTION
0287361 	0004634429 0004634429 0009964845 0014607048 A0004634429 A0009964845	L=75 M=26x1,5 RHT	NG - SK
0288930 	0014601648 0014601648	L=75 M=26x1,5 RHT	LP-LPL-LPK-LPO-LPS-LPLS
0287313 	6244600348 6244600348	L=85 M=26x1,5 RHT	NG - SK
0180727 	6013300435 6013305335 6013300635	L=95 M=20x1,5 RHT	T2/LN1 (507 D > 510) - VARIO: 512 D > 818 D (667 - 668 - 670)
0190727 	6013305235 6013300535 6013300735 6013305235	L=95 M=20x1,5 LHT	T2/LN1 (507 D > 510) - VARIO: 512 D > 818 D (667 - 668 - 670)
0186595 	0003308535 0003308535 0003300335 0003300635 0003302410 0004633229 0003308735 0003306735	L=95 M=24x1,5 RHT	608-709-709K-711-808-809-811-813 - 911B-913-914-917-1013-1114-1117 - 1120 Unimog U -NG: 1013-1017 - LK/LN2: 814-817-914-917 - ATEGO I: 815-817-823-917-923-925 - 1017-1023
0196595 	0003308635 0003308635 0003300235 0003300735 0003308835 0003306835	L=95 M=24x1,5 LHT	608-709-709K-711-808-809-811-813 - 911B-913-914-917-1013-1114-1117 - 1120 Unimog U -NG: 1013-1017 - LK/LN2: 814-817-914-917 - ATEGO I: 815-817-823-917-923-925 - 1017-1023
0187560 	0013301435 0013301435 0003301035 0003381610 0013301235 0003301135 0003301635	L=95 M=24x1,5 RHT	
0180730 	0004608548 3103301335 0004608548 0004604148 0003305035 0004604348 0004602148 0004604542	L=95 M=22x1,5 RHT	NG - SK - T1 - T2/L - 601 - 602 - TN1 - TN - T2/L - LK









TESTE STERZO - TIE RODS END

RIF. OCAP OCAP REF.	RIF. ORIG O.E. NUMBER	NOTE REMARKS	MODELLO / DESCRIZIONE MODEL / DESCRIPTION
0182260 	0013304835 4603301235 0004607248 0013304835	L=95 M= 20x1,5 RHT	100 (Furgonato) - G-Class (Fuoristrada aperto/open off-road) - G-Class W 460-W 461-W463 (Fuoristrada chiuso/close off-road)
0287684 	0004604948 0004604948 0004634629 0024600948	L=95 M=26x1,5 RHT	ATEGO - ACTROS MP2 - AXOR - SK
0198931 	0003301135 0003301135	L=96 M=24x1,5 LHT	
0188932 	0003384923 0003384923	L=100 M=24x1,5 RHT	
0186612 	0003309735 0003309735 0003309935 0003301235 0003307535 0003383429 0003383529	L=105 M=24x1,5 RHT	T2 - 507D/DK-508D-510-609D/DK - 611D-709D/DK-711D-714D-809D/DT/DK - 811 D/DT/DK-814D - NG: 1013 - VARIO: 512D-612D-613D-615D - 812D-813D-814D-815D-816D-815DA-816DA
0196612 	0003309835 0003309835 0003301335 0003307635 0013300035 0023301435	L=105 M=24x1,5 LHT	T2: - 507D/DK-508D-510-609D/DK - 611D-709D/DK-711D-714D-809D/DT/DK - 811 D/DT/DK-814D
0186613 	0003309335 0003309335 0003301435 0003301535 0003307135 0003309535 0003382129	L=105 M=28x1,5 RHT	ATEGO I - PS - LK - NG - T2
0196613 	0003309435 0003309435 0003303335 0003307235 0003309635	L=105 M=28x1,5 LHT	ATEGO I - PS - LK - NG - T2
0187342 	0004604348 0004604348 0003381810 0003305635 0004605648 3103300635 3103301035 3103301235	L=105 M=24x1,5 RHT	T2/L: - 508/DG-608/D-613/D - Unimog U









TESTE STERZO - TIE RODS END

RIF. OCAP OCAP REF.	RIF. ORIG O.E. NUMBER	NOTE REMARKS	MODELLO / DESCRIZIONE MODEL / DESCRIPTION
0186424 	0014603448 0014603448 0013300235 0013300135 0004633529 0004633429 0004608348 0003383410 0003307335 0003305835 0003303235 0003300248 3503307035 0014632229 3024633429 0014609748	L=115 M=30x1,5 RHT	ATEGO I - ACTROS - ACTROS MP2 - MP3 - AXOR - LK - MK - NG
0196424 	0013308835 0013308835 0003300148 3023300035 3023300135 3023300235 3023300335 0003300035 3503307135 0024600248	L=115 M=30x1,5 LHT	ATEGO I - ACTROS - ACTROS MP2 - MP3 - AXOR - LK - MK - NG
0188933 	0014608248 0014608248	L=115 M=28x1,5 RHT	ACTROS-ACTROS MP3/MP3-ATEGO-AXOR
0186547 	0013300335 0013300335 0013300435 0003303135 0003308135	L=115 M=30x1,5 RHT	LK - LP - LPK - LPS - NG
0187959 	0014609948 0014603848 0014604848 0014605148 0014608648 0014609948	L=115 M=30x1,5 RHT	ACTROS - ANTOS - AXOR
0187146 	0004602648 0004602648 0004600148 0004602748	L=120 M=30x1,5 RHT	LK/LN2 - NG
0186598 	0004602248 0004602848 0004602248 0004602948 0014600248 0004600348 0014600848 0014601248 0004608948 0014600948 0014602248 0014607748 0024600148	L=120 M=30x1,5 RHT	ACTROS - MP2 - MP3 - ATEGO - ATEGO 2 - AXOR II - LK - LN2 - MK - NG - SK

TESTE STERZO - TIE RODS END

RIF. OCAP OCAP REF.	RIF. ORIG O.E. NUMBER	NOTE REMARKS	MODELLO / DESCRIZIONE MODEL / DESCRIPTION
0196598 	0004603448 0004603448 0004600648 0004603548 0004601248 0014601448 0014600348 0014602348 0014603748 0024600348	L=120 M=30x1,5 LHT	ACTROS - MP2 - MP3 - ATEGO - AXOR II - LK - LN2 - MK - NG - SK
0186551 	0004606848 0004606848 0004605748 0004606048 0004607048 0014601148 0014607648 0014600448 0014601748 0014609648	L=120 M=30x1,5 RHT	ACTROS - ACTROS MP2 - MP3 - ATEGO - AXOR I - AXOR II - ECONIC - MK-NG-SK
0196961 	0004606948 0004606948 0004605848 0004606148 0004607148 0014600548 0014601348 0014607948 0014602548	L=120 M=30x1,5 LHT	ACTROS - ACTROS MP2 - MP3 - ATEGO - AXOR I - AXOR II - ECONIC - MK-NG-SK
0186599 	0013301835 0013301835	L=120 M=38x1,5 RHT	ACTROS - ACTROS MP2 - MP3 - ATEGO - AXOR II - NG - 2628A/ AK/AS-2635A-2636A - 3250-3336AK-3535-3850
0187467 	0004601748 0004601748	L=135 M=38x1,5 RHT	ACTROS/ACTROS MP2 - MP3 - ATEGO II - NG - SK - AXOR II
0197467 	6.851.490.000 6.851.490.000 1203.223.00	L=135 M=38x1,5 LHT	ACTROS/ACTROS MP2 - MP3 - ATEGO II - NG - SK - AXOR II
0287136 	0013302135 0013302135 0013302635 0003304035 0003307735 0003384929 0003302835	L=140 M=35x1,5 RHT	O 303 - O 305 - 0307 - O 340 - O 405 - O 407 - O 408 - SK
0297136 	0013302235 0013302235 0013302735 0003304135 0003307835 0003385029 0003302935	L=140 M=35x1,5 LHT	O 303 - O 305 - 0307 - O 340 - O 405 - O 407 - O 408 - SK







TESTE STERZO - TIE RODS END

RIF. OCAP OCAP REF.	RIF. ORIG O.E. NUMBER	NOTE REMARKS	MODELLO / DESCRIZIONE MODEL / DESCRIPTION
0187916 	0014602948 0014602948	L=146 M30x1,5 RHT	ACTROS MP2 - MP3
0186442 	6994601648 6994601648	L=154 M=30x1,5 RHT	
0187789 	0014604148 0014604148 0014605048 0014604248 0014608548 0024600548 0014608448 0014608948	L=141 M=28X1,5 RHT	ACTROS - ATEGO - AXOR
0187971 	0014600648 0004604848 0014600648	L=155 M=30x1,5 RHT	MK - NG - SK
0197971 	0014600748 0004608448 0014600748	L=155 M=30x1,5 LHT	MK - NG - SK
0180729 	0013300735 0013300735 0003307035 0013301035 0003302735 0013300935 0003300835 0003302635	L=160 M=24x1,5 RHT	309/310-313-406-407-408 - 409-410-508-608-613
0190729 	0013300835 0013300835 0003302635 0003306935	L=160 M=24x1,5 LHT	309/310-313-406-407 - 408-409-410-508-608-613
0190731 	0004608648 0004602248 0004608648 0004604648 0004604248 0004608748	L=250 M=22x1,5 LHT	T1: 601-602 (furgonato/van) - T1/TN: 407-408-409-410
0196547 	- -	L=115 M=30x1,5 LHT	LK - LN

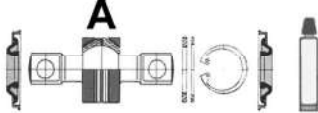
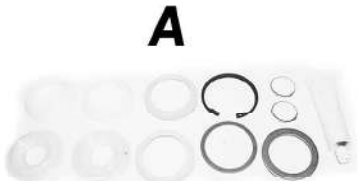





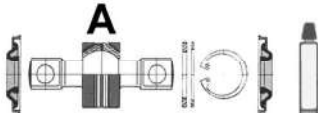

TESTE STERZO - TIE RODS END

RIF. OCAP OCAP REF.	RIF. ORIG O.E. NUMBER	NOTE REMARKS	MODELLO / DESCRIZIONE MODEL / DESCRIPTION
0186961 	0004606848	L=120	ACTROS - ACTROS MP2 - MP3
	0004606848	M=30x1,5 RHT	ATEGO 2
	0014607648		AXOR
	0014601748		
	0004605748		
	0004607548		
	0014600448		
	0014601148		
	0014602448		
0004607048			



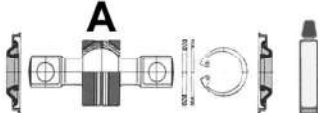

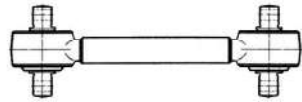

BARRE DI REAZIONE - TORQUE RODS

RIF. OCAP OCAP REF.	RIF. ORIG O.E. NUMBER	NOTE REMARKS	MODELLO / DESCRIZIONE MODEL / DESCRIPTION
0807642 	6533500006 6533500006 3853500006	L=500 d=21	MK - NG - 240.35
0907556 	0003500213 0003500213 0005861433 0003500305 0003500505	l=152 p=24 D=65 d=21	
0907586 	0005861533 0005861533	D=65	senza perno (without pin)
0808972 	6533500606 6533500606	L=510 d=21	MK - NG
0907304 	0003500613 0003500613 0005861135 0003501805	l=152 p=24 d=21	MK - NG
0807585 	6523500306 6523500306 3813500606 6533500106	L=522 d=21	MK - NG - SK
0907304 	0003500613 0003500613 0005861135 0003501805	l=152 p=24 D=70 d=21	
0807825 	3933200332 3933200332	L=553 d=21	1632-2632
0907556 	0003500213 0003500213 0005861433 0003500305 0003500505	l=152 p=24 D=65 d=21	

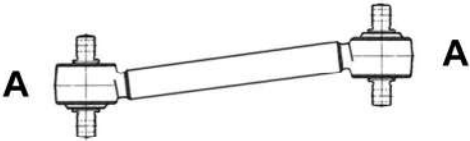

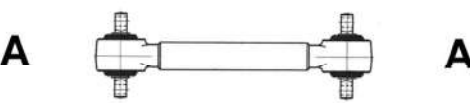
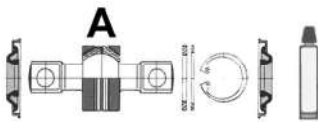
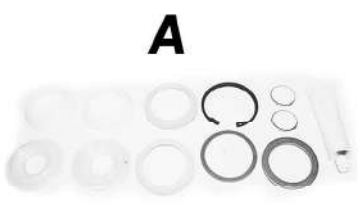
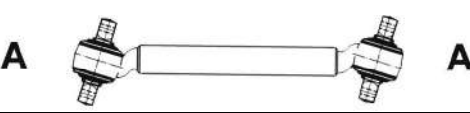

BARRE DI REAZIONE - TORQUE RODS

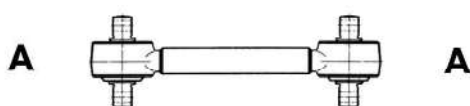
RIF. OCAP OCAP REF.	RIF. ORIG O.E. NUMBER	NOTE REMARKS	MODELLO / DESCRIZIONE MODEL / DESCRIPTION
0907586 A 	0005861533 0005861533	D=65	senza perno (without pin)
0807669 A  A	9483501205 9483501205 9483500605 9483501305 9483500805 9473500005 9483502005 9483502405	L=565 T=52 d=21	ACTROS - MP2 - MP3 - ATEGO - AXOR - AXOR II
0907547 A 	0003502705 0003502705	l=152 D=70 d=21	
0807606 A  A	3953200132 3953200132	L=568 d=21	LPL 2232-L/LB/LK/LS 2624(6x4) - LA/LAB/LAK/LAS:2624 (6x4) - NG:2226/2232:/S/LS - 2626/A/B/AB/AS/AK/K/S - 2632/A/AK/AS/K/S
0907556 A 	0003500213 0003500213 0005861433 0003500305 0003500505	l=152 p=24 D=65 d=21	
0907586 A 	0005861533 0005861533	D=65	senza perno (without pin)
0807611 A  A	6593501106 6593501106 3953500006 6243500006 6593503406	L=579 d=21	ACTROS - ATEGO I/II - ECONIC - NG
0907330 A 	0003500413 0003500413 0005861235	l=152 p=24 D=80 d=21	



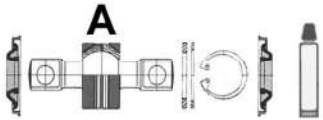
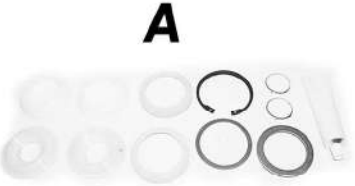

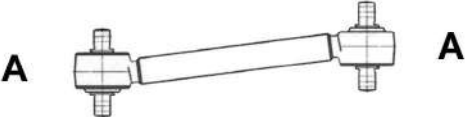

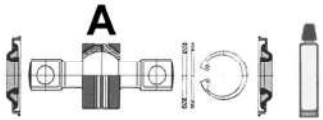
BARRE DI REAZIONE - TORQUE RODS

RIF. OCAP OCAP REF.	RIF. ORIG O.E. NUMBER	NOTE REMARKS	MODELLO / DESCRIZIONE MODEL / DESCRIPTION
0807616 	6593501206 6593501206 6243500106 6593503506 653503506	L=579	NG - SK
0907304 	0003500613 0003500613 0005861135 0003501805	l=152 p=24 D=70 d=21	
0807826 	3893200732 3893200732	L=582 d=21	1626-1628-1632-1926-1928-1932 - 2226-2228-2232-2235-2244
0907556 	0003500213 0003500213 0005861433 0003500305 0003500505	l=152 p=24 D=65 d=21	
0907586 	0005861533 0005861533	D=65	senza perno (without pin)
0807615 	6593500427 6593500427	L=585	LPL 2232-L/LB/LK/LS 2624 (6x4) - LA/LAB/LAK/LAS 2624 (6x6) - 2626/B/K/S/AK-2628-2632
0907304 	0003500613 0003500613 0005861135 0003501805	l=152 p=24 D=70 d=21	
0807605 	6593500124 6593500124	L=585	2422-2426-2426B - 2429/K/LS/S-2433/K-2435/L/LS/S - 2448/LS/S-2472/B--2531-2534K - 2535L-2538/K-2544/K/LS/S-2550 - 3235L-3248-3255
0907304 	0003500613 0003500613 0005861135 0003501805	l=152 p=24 D=70 d=21	
0807612 	3953200206 3953200206	L=585	LPL 2232-L/LB/LK/LS 2624 (6x4) - LA/LAB/LAK/LAS 2624 (6x6) - 2632/K/S-2636/K

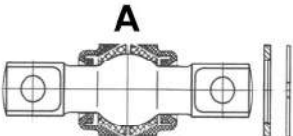
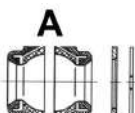
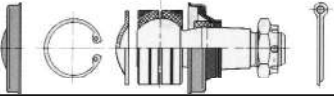
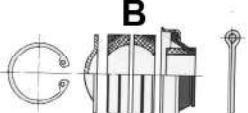

BARRE DI REAZIONE - TORQUE RODS

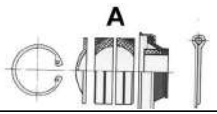
RIF. OCAP OCAP REF.	RIF. ORIG O.E. NUMBER	NOTE REMARKS	MODELLO / DESCRIZIONE MODEL / DESCRIPTION
0907556 	0003500213 0003500213 0005861433 0003500305 0003500505	l=152 p=24 D=65 d=21	
0907586 	0005861533 0005861533	D=65	senza perno (without pin)
0807643 	6593500106 6593500106 3953500206 6593502406	L=585 d=21	MK - NG - SK
0907304 	0003500613 0003500613 0005861135 0003501805	l=152 p=24 D=70 d=21	
0807617 	6593500406 6593500406 3953500706 6593502706	L=585 d=21	NG - SK
0907304 	0003500613 0003500613 0005861135 0003501805	l=152 p=24 D=70 d=21	
0807586 	6553500006 6553500006 6583500206 3933200132 6583500006 653500006	L=585 d=21	NG - SK
0907556 	0003500213 0003500213 0005861433 0003500305 0003500505	l=152 p=24 D=65 d=21	





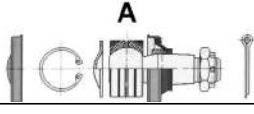
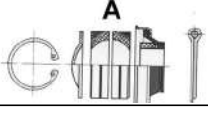
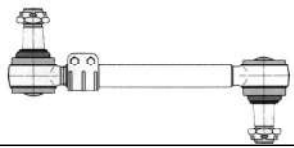
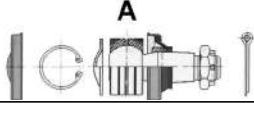
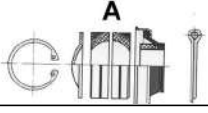
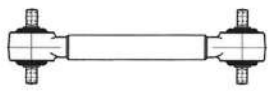
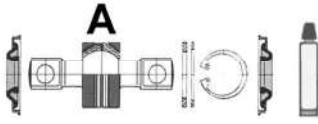
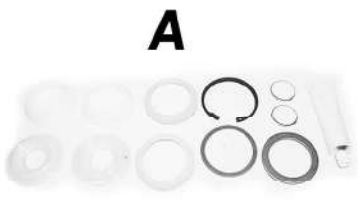

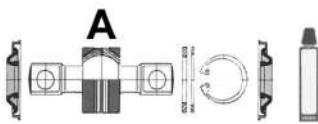

BARRE DI REAZIONE - TORQUE RODS

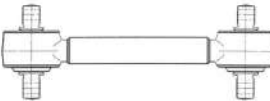
RIF. OCAP OCAP REF.	RIF. ORIG O.E. NUMBER	NOTE REMARKS	MODELLO / DESCRIZIONE MODEL / DESCRIPTION
0907586 A 	0005861533 0005861533	D=65	senza perno (without pin)
0807638 A  B	3523500306 3523500306	L=587 d=19	LP 2219 (6x2)
0907638 A 	0005860132 0005860132	l=152 p=24 D=65 d=19	
0907836 A 	0005860732 0005860732	D=65	senza perno (without pin)
0907601 B 	3435860032 3435860032 0005861633	L=160 K=45 D=65	
0907602 B 	0005860632 0005860632 0005861733	D=65	senza perno (without pin)
0807601 A  A	3433201632 3433201632 3433201832 3433201732	L=595	2220-2620-2623-2624
0907601 A 	3435860032 3435860032 0005861633	L=160 K=45 D=65	
0907602 A 	0005860632 0005860632 0005861733	D=65	senza perno (without pin)
0807602 A  A	3433201732 3433201732 3433201032 3433201632 3433201832	L=595	1813-1817-1819 - 2219-2220-2620-2622-2623 - 2624-2626A/AS/ AB/AK - 2632A/AK/AS

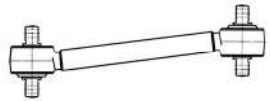



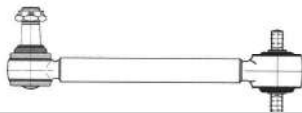

BARRE DI REAZIONE - TORQUE RODS

RIF. OCAP OCAP REF.	RIF. ORIG O.E. NUMBER	NOTE REMARKS	MODELLO / DESCRIZIONE MODEL / DESCRIPTION
0907601 	3435860032 3435860032 0005861633	L=160 K=45 D=65	
0907602 	0005860632 0005860632 0005861733	D=65	senza perno (without pin)
0807637 	3433201832 3433201832 3433201632 3433201732	L=595	26.24
0907601 	3435860032 3435860032 0005861633	L=160 K=45 D=65	
0907602 	0005860632 0005860632 0005861733	D=65	senza perno (without pin)
0807556 	3813500206 3813500206 3833500006	L=595 d=21	L/LB/LK/LS:2624 - LA/LAB/LAK/LAS:2624 - LPL:2232 - NG: 2226/ S/LS-2232/S/LS - 2626/B/K/S-2632/K/S
0907556 	0003500213 0003500213 0005861433 0003500305 0003500505	l=152 p=24 D=65 d=21	
0907586 	0005861533 0005861533	D=65	senza perno (without pin)
0807587 	6553500306 6553500306 6203500106 620350006	L=595 d=21	NG - LS/S - SK - MK
0907556 	0003500213 0003500213 0005861433 0003500305 0003500505	l=152 p=24 D=65 d=21	

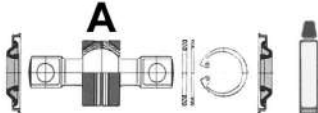





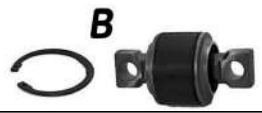
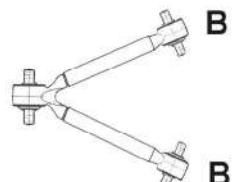

BARRE DI REAZIONE - TORQUE RODS

RIF. OCAP OCAP REF.	RIF. ORIG O.E. NUMBER	NOTE REMARKS	MODELLO / DESCRIZIONE MODEL / DESCRIPTION
0907586 A 	0005861533 0005861533	D=65	senza perno (without pin)
0807614 A  A	3953500606 3953500606	L=595 d=21	LPL 2232-L/LB/LK/LS 2624 (6x4) - LA/LAB/LAB/LAS 2624 (6x6) - 2626/B/K/S-2632
0907330 A 	0003500413 0003500413 0005861235	l=152 p=24 D=80 d=21	
0807600 A  A	3953500806 3953500806	L=595 d=21	1628-1633-1636-1638-1644-1928 - 1933-1935-1936-1938-1944-2028-2033 - 2035-2036-2244-2428-2429-2435-2438
0907304 A 	0003500613 0003500613 0005861135 0003501805	l=152 p=24 D=70 d=21	
0807608 A  A	3953200332 3953200332 3853500106	L=610 d=21	LP/LPL/LPS/LPLS 608/709/813 - LP/LPL 809/913 - LPL 2232 - L/LB/LK/LS 2624 (6x4) - LA/LAB/LAK/LAS 2624 (6x6) - NG:2219/K/KO-2224/B/K/S-2632/K/S
0907304 A 	0003500613 0003500613 0005861135 0003501805	l=152 p=24 D=70 d=21	
0807603 A  B	3853500206 3853500206 3813500306	L=612 d=21	NG: 2219/C/CL/L/K/KO - 2224/B/K/S
0907531 A 	0003501013 0003501013	D=70 K=45	
0907304 B 	0003500613 0003500613 0005861135 0003501805	l=152 p=24 D=70 d=21	





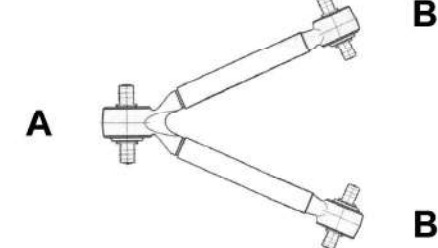

BARRE DI REAZIONE - TORQUE RODS

RIF. OCAP OCAP REF.	RIF. ORIG O.E. NUMBER	NOTE REMARKS	MODELLO / DESCRIZIONE MODEL / DESCRIPTION
0807827  A A	3893200832 3893200832	L=614 d=21	1813-1817-1819
0907556  A	0003500213 0003500213 0005861433 0003500305 0003500505	l=152 p=24 D=65 d=21	
0907586  A	0005861533 0005861533	D=65	senza perno (without pin)
0808975  A A	9453500105 9453500105	L=615	ACTROS - AXOR - ZETROS
0907547  A	0003502705 0003502705	l=152 D=70 d=21	
0807908  A B B	9483502205 9483502205 9483502305	L=621,5	ACTROS 1996 > - ACTROS MP2-MP3 - AXOR 2
0907908  A	0003503605 0003503605	l=152 p=30 d=25	
0907909  B	0003503705 0003503705	l=130 p=30 d=23	
0807599  B B	9423500505 9423500505 9423501205 9423500805 3753500505	L=622	ACTROS Serie U: - (1996) 1831/S-1835/S-1840/S - 1843/S-1848/ S-1853/S-1857/LS - AXOR: - 2535/LS-2540/LS-2543/LS - AXOR 2 - ATEGO - MP2 - MP3



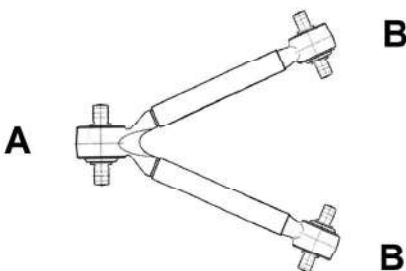

BARRE DI REAZIONE - TORQUE RODS

RIF. OCAP OCAP REF.	RIF. ORIG O.E. NUMBER	NOTE REMARKS	MODELLO / DESCRIZIONE MODEL / DESCRIPTION
0907599  B	0003502505 0003502505	l=152 p=24 D=62 d=25	
0808980  A B B	9443500405 9443500405	L=622 T=46	
0907634  A	0003502305 0003502305 0003504405	l=152 p=24 D=70 d=25	
0907599  B	0003502505 0003502505	l=152 p=24 D=62 d=25	
0808981  B B	9423500905 9423500905	L=622 T=46	
0907840  B	0003504805 0003504805	l=130 p=30 D=85 d=23	
0807634  A B B	9443500005 9423501005 9473500105 9423501505 9443500005 9473501005	L=622 d=25	ACTROS - ACTROS MP2 - MP3 - ATEGO - AXOR - AXOR 2 - ECONIC: 1823-1828-2628
0907634  A	0003502305 0003502305 0003504405	l=152 p=24 D=70 d=25	



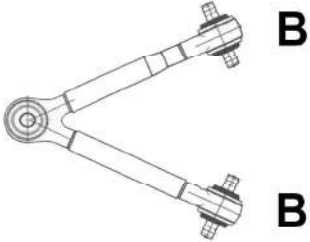

BARRE DI REAZIONE - TORQUE RODS

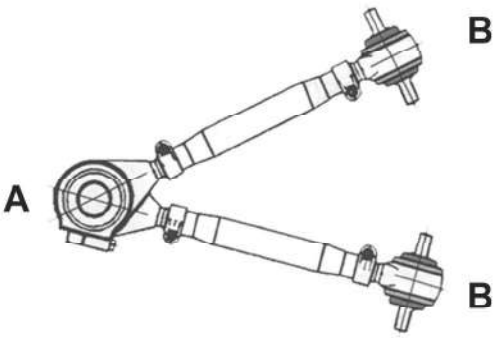
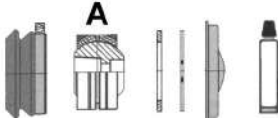
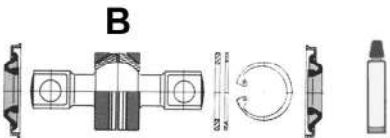
RIF. OCAP OCAP REF.	RIF. ORIG O.E. NUMBER	NOTE REMARKS	MODELLO / DESCRIZIONE MODEL / DESCRIPTION
0907599 	0003502505 0003502505	l=152 p=24 D=62 d=25	
0808982 	9483502905 9483502905	L=622 T=46	
0907774 	0003502405 0003502405	l=152 p=24 D=80 d=25	
0907599 	0003502505 0003502505	l=152 p=24 D=62 d=25	
0807984 	9423501105 3753500105 9423500105 9423500705 9423501105 9423501605	L=622 T=46	ACTROS - ACTROS MP2/MP3 - ATEGO - AXOR - AXOR 2 - ECONIC
0907622 	0003502105 0003502105 0003504605	l=152 D=75 d=25	
0907984 	0003502005 0003502005 0003504705	l=130 p=23 D=67 d=23	
0807774 	9483500405 9483500405 9483503005 9483501105 3753500205 9443500305 9443500505 9473500905 9473500705	L=622 d=25	ACTROS: 3331-3335-3340-3343 - 3346-3348-3353-3357-4140-4143 - 4148 - ACTROS MP2 - MP3 - ATEGO - AXOR - AXOR 2



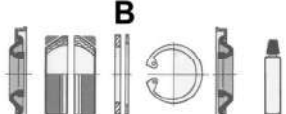
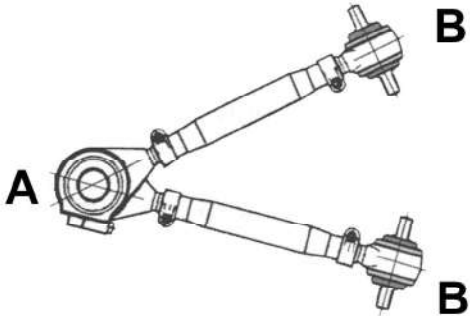
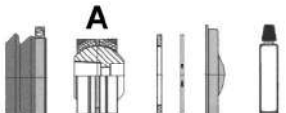
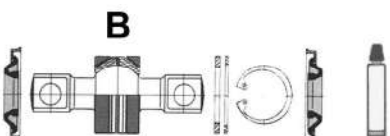
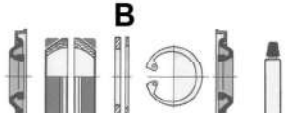





BARRE DI REAZIONE - TORQUE RODS

RIF. OCAP OCAP REF.	RIF. ORIG O.E. NUMBER	NOTE REMARKS	MODELLO / DESCRIZIONE MODEL / DESCRIPTION
0907774 	0003502405 0003502405	l=152 p=24 D=80 d=25	
0907599 	0003502505 0003502505	l=152 p=24 D=62 d=25	
0807619 	6583500105 6583500105 6583500205 6563500005 6533500205	L=622 d=25	SK
0907925 	0003501705		
0907304 	0003500613 0003500613 0005861135 0003501805	l=152 p=24 D=70 d=21	
0807218 	6553500305 6553500305 3933505405 3933505505 6533500105 6583500005 6533500005 3833500105 3933505205 3933505305	L=623 d=21	NG - SK
0907584 	0003500105 0003500405 0003500105 0005861833 0005860135 0005861933	L=62 IK=40 D=80	
0907556 	0003500213 0003500213 0005861433 0003500305 0003500505	l=152 p=24 D=65 d=21	

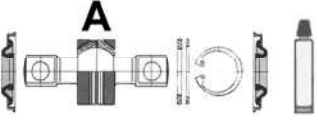

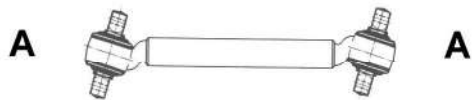
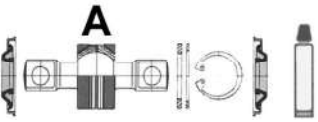

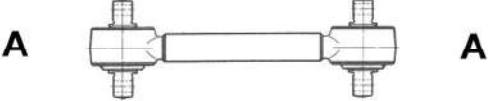

BARRE DI REAZIONE - TORQUE RODS

RIF. OCAP OCAP REF.	RIF. ORIG O.E. NUMBER	NOTE REMARKS	MODELLO / DESCRIZIONE MODEL / DESCRIPTION
0907586 	0005861533 0005861533	D=65	senza perno (without pin)
0807867 	6543500105 6543500105 6543500005 6543500305	L=623 d=21	MK: 1420/L/LS - 1422/L/LS/S-1424/L/LS/S - 1426/LS/S-1717/L-1720/L - 1722/L-1726/LS/S-1733/LS/S - 1820/L-1824/L-1827/LS/L/S - 1831/L-1834/L/LS/S-2420/L - 2422/L-2426/L-2433/LS/S - 2524/L-2527/L-2531/L - 2534/L/LS/S
0907584 	0003500105 0003500405 0003500105 0005861833 0005860135 0005861933	L=62 IK=40 D=80	
0907556 	0003500213 0003500213 0005861433 0003500305 0003500505	l=152 p=24 D=65 d=21	
0907586 	0005861533 0005861533	D=65	senza perno (without pin)
0808983 	6533500305 6533500305	L=623	
0908983 	0003501405 0003501405		
0808984 	6533500405 6533500405	L=623	

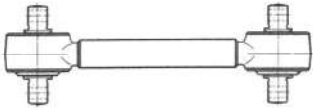
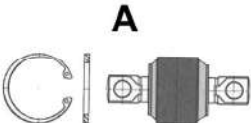
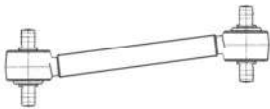

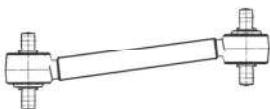

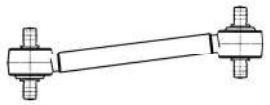

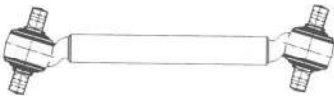
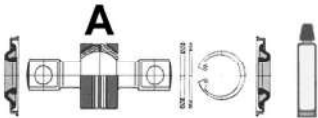

BARRE DI REAZIONE - TORQUE RODS

RIF. OCAP OCAP REF.	RIF. ORIG O.E. NUMBER	NOTE REMARKS	MODELLO / DESCRIZIONE MODEL / DESCRIPTION
0908983 	0003501405 0003501405		
0807828 	3933200232 3933200232	L=627 d=21	NG:1632-2626-2632
0907556 	0003500213 0003500213 0005861433 0003500305 0003500505	l=152 p=24 D=65 d=21	
0907586 	0005861533 0005861533	D=65	senza perno (without pin)
0807607 	3953201532 3953201532	L=628 d=21	LPL 2232 - L/LB/LK/LS:2624(6x4) - LA/LAB/LAK/LAS 2624(6x6) - NG:2226/2232:/S/LS - 2626/B/K/S-2632/K/S - 2636AK/K-3332
0907556 	0003500213 0003500213 0005861433 0003500305 0003500505	l=152 p=24 D=65 d=21	
0907586 	0005861533 0005861533	D=65	senza perno (without pin)
0807829 	6593501306 6593501306 3953501006 6243500206 6593503606	L=629 d=21	NG: - 2626-2628-2632-2633-2635 - 2636-3333-3336-3528-3535 - SK: - 2629-2631-2635-2638-2644 - 3538
0907330 	0003500413 0003500413 0005861235	l=152 p=24 D=80 d=21	



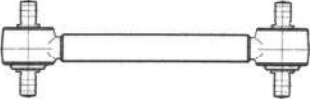
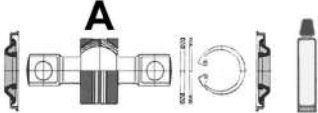





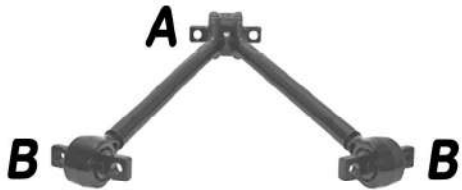

BARRE DI REAZIONE - TORQUE RODS

RIF. OCAP OCAP REF.	RIF. ORIG O.E. NUMBER	NOTE REMARKS	MODELLO / DESCRIZIONE MODEL / DESCRIPTION
0807618 A  A	6593501606 6593501606 3953501306 6243500506 6593501006 6593503306 6593503906	L=629 d=21	MK - NG: 2632-3250A/AF-3850A - SK:4050
0907541  A	0003500113 0003500113	l=152 p=24 D=90 d=21	
0807613 A  A	6593501406 6593501406 6243500306 6593503706	L=629 d=21	LPL 2232-L/LB/LK/LS (6x4) - LA/LAB/LAK/LAS (6x6)-2626/B/K/S - 2626 K(6x4)-2626AK(6x6)-2628AK - 2628 AS(6x6)-2636/K - 2636/AS/AK (6x6)
0907304 A  A	0003500613 0003500613 0005861135 0003501805	l=152 p=24 D=70 d=21	
0807830 A  A	6593501506 6593501506 6243500406 6593503806	L=629 d=21	NG: 2626-2628-2632-2633-2635 - 2636-2644-3250-3333-3336-3528 - 3535-3850 - SK: 2629-2631-2635-2638-2644 - 2648-2650-3534-3535-3538 - 3550-3553
0907330 A  A	0003500413 0003500413 0005861235	l=152 p=24 D=80 d=21	
0807831 A  A	3953501206 3953501206 3953501106 6593500906 6593503206	L=635 d=21	NG: - 2626-2628-2632-2633-2635-2636 - 3250-3333-3336-3535-3850 - SK: - 2629-2631-2635-2638-2644-3538
0907330 A  A	0003500413 0003500413 0005861235	l=152 p=24 D=80 d=21	
0807610 A  A	3953201432 3953201432	L=638 d=21	LPL 2232- L/LB/LK/LS 2624 (6x4) - LA/LAB/LAK/LAS 2624 (6x6) - NG: 2226K-2626/B/K/S-2632/K/S
0907556  A	0003500213 0003500213 0005861433 0003500305 0003500505	l=152 p=24 D=65 d=21	



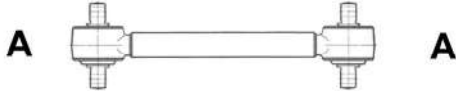



BARRE DI REAZIONE - TORQUE RODS

RIF. OCAP OCAP REF.	RIF. ORIG O.E. NUMBER	NOTE REMARKS	MODELLO / DESCRIZIONE MODEL / DESCRIPTION
0907586 A 	0005861533 0005861533	D=65	senza perno (without pin)
0808976 A  B	6543500406 6543500406	L=652	MK
0907623 A 	0003501905 0003501905 639340 082751027		MK
0907304 B 	0003500613 0003500613 0005861135 0003501805	l=152 p=24 D=70 d=21	MK
0807604 A  A	6593502206 6593502206 6193500206 6593504506	L=660 d=21	2225-3025 K-3229
0907556 A 	0003500213 0003500213 0005861433 0003500305 0003500505	l=152 p=24 D=65 d=21	
0907586 A 	0005861533 0005861533	D=65	senza perno (without pin)
0808985 A  B	9483502805 9483502805	L=667	
0907908 A 	0003503605 0003503605	l=152 p=30 d=25	
0907909 B 	0003503705 0003503705	l=130 p=30 d=23	







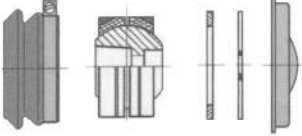

BARRE DI REAZIONE - TORQUE RODS

RIF. OCAP OCAP REF.	RIF. ORIG O.E. NUMBER	NOTE REMARKS	MODELLO / DESCRIZIONE MODEL / DESCRIPTION
0808986 	9483500905 9483500905	L=667	
0907908 	0003503605 0003503605	l=152 p=30 d=25	
0907909 	0003503705 0003503705	l=130 p=30 d=23	
0807671 	9413300011 9413300011 000360098524	L=754 d=17	ACTROS - ACTROS MP2 - MP3 - ATEGO - AXOR 2 - ECONIC: 1823-1828-2628
0907671 	0003310017 0003310017		ACTROS - ACTROS MP2 - MP3 - ATEGO - AXOR 2 - ECONIC: 1823-1828-2628
0907635 	0003301411 0003301411	l=100 p=20 D=55 d=17	ACTROS - ACTROS MP2 - MP3 - ATEGO - AXOR 2 - ECONIC: 1823-1828-2628
0807670 	9453300011 9453300011	L=755 d=17	ACTROS - ACTROS MP2 - MP3 - ATEGO: 2523-2528
0907635 	0003301411 0003301411	l=100 p=20 D=55 d=17	
0808987 	9743500005 9743500005	L=761,70	
0907622 	0003502105 0003502105 0003504605	l=152 D=75 d=25	







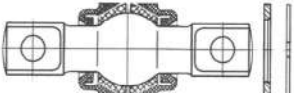

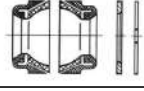

BARRE DI REAZIONE - TORQUE RODS

RIF. OCAP OCAP REF.	RIF. ORIG O.E. NUMBER	NOTE REMARKS	MODELLO / DESCRIZIONE MODEL / DESCRIPTION
0907984 B 	0003502005 0003502005 0003504705	l=130 p=23 D=67 d=23	
0807636 A  A	9413300007 9413300007	L=845 d=17	ACTROS - MP2 - MP3 - ATEGO - ATEGO 2 - AXOR 2 - ECONIC
0907635 A 	0003301411 0003301411	l=100 p=20 D=55 d=17	
0807635 A  A	9453300007 9453300007	L=850 d=17	ACTROS - ACTROS MP2 - MP3 - ATEGO - ATEGO 2 - ECONIC - AXOR 2
0907635 A 	0003301411 0003301411	l=100 p=20 D=55 d=17	
0809444 	9603500906 9603500906	L=532 T=46 l=130 d=21	ACTROS MP4 - MP5











KIT DI SOSPENSIONE - SUSPENSION KITS

RIF. OCAP OCAP REF.	RIF. ORIG O.E. NUMBER	NOTE REMARKS	MODELLO / DESCRIZIONE MODEL / DESCRIPTION
0907584 	0003500105 0003500405 0003500105 0005861833 0005860135 0005861933	L=62 IK=40 D=80	NG - MK - SK - ACTROS - ATEGO
0907601 	3435860032 3435860032 0005861633	L=160 K=45 D=65	
0907635 	0003301411 0003301411	l=100 p=20 D=55 d=17	ACTROS - ACTROS MP2 - MP3 - ATEGO - ATEGO 2 - ECONIC - AXOR 2
0907201 	0003501505 0003501505		MK - SK
0907620 	0003500205 0003500205		MK - NG
0907621 	0005861035 0005861035		NG
0907609 	0003502205 0003502205 0003504505	l=130 p=24 D=62 d=25	ACTROS
0907599 	0003502505 0003502505	l=152 p=24 D=62 d=25	ACTROS Serie U: - (1996) 1831/S-1835/S-1840/S - 1843/S-1848/S-1853/S-1857/LS - AXOR: - 2535/LS-2540/LS-2543/LS - AXOR 2 - ATEGO - MP2 - MP3
0907925 	0003501705		MK-SK
0907638 	0005860132 0005860132	l=152 p=24 D=65 d=19	LP

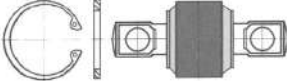
KIT DI SOSPENSIONE - SUSPENSION KITS

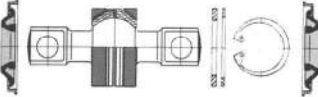
RIF. OCAP OCAP REF.	RIF. ORIG O.E. NUMBER	NOTE REMARKS	MODELLO / DESCRIZIONE MODEL / DESCRIPTION
0907602 	0005860632 0005860632 0005861733	D=65	2220-2620-2623-2624 - 1813-1817-1819-2219-2220-2620-2622-2623 - 2624-2626A/AS/AB/AK-2632A/AK/AS
0907836 	0005860732 0005860732	D=65	LP - senza perno (without pin)
0907586 	0005861533 0005861533	D=65	NG - MK - senza perno (without pin)
0907927 	0003300511 0003300511	p=24 D=67 d=19	CITARO - CONECTO - O 405
0907840 	0003504805 0003504805 0003503305	l=130 p=30 D=85 d=23	ACTROS - AXOR
0907909 	0003503705 0003503705	l=130 p=30 d=23	ACTROS 1996 > - ACTROS MP2-MP3 - AXOR 2
0907907 	0003502805 0003502805	l=130 p=24,3 d=25	
0907984 	0003502005 0003502005 0003504705	l=130 p=23 D=67 d=23	ACTROS - ACTROS MP2/MP3 - ATEGO - AXOR - AXOR 2 - ECONIC
0907531 	0003501013 0003501013	D=70 K=45	NG: 2219/C/CL/L/K/KO - 2224/B/K/S
0907634 	0003502305 0003502305 0003504405	l=152 p=24 D=70 d=25	ACTROS
0907547 	0003502705 0003502705	l=152 D=70 d=21	ACTROS - MP2 - MP3 - ATEGO - AXOR - AXOR II

KIT DI SOSPENSIONE - SUSPENSION KITS

RIF. OCAP OCAP REF.	RIF. ORIG O.E. NUMBER	NOTE REMARKS	MODELLO / DESCRIZIONE MODEL / DESCRIPTION
0907330 	0003500413 0003500413 0005861235	l=152 p=24 D=80 d=21	
0907908 	0003503605 0003503605	l=152 p=30 d=25	ACTROS 1996 > - ACTROS MP2-MP3 - AXOR 2
0907622 	0003502105 0003502105 0003504605	l=152 D=75 d=25	ACTROS-ATEGO-AXOR-ECONIC-MK
0907774 	0003502405 0003502405	l=152 p=24 D=80 d=25	ACTROS: 3331-3335-3340-3343 - 3346-3348-3353-3357-4140-4143 - 4148 - ACTROS MP2 - MP3 - ATEGO - AXOR - AXOR 2
0907541 	0003500113 0003500113	l=152 p=24 D=90 d=21	MK - NG: 2632-3250A/AF-3850A - SK:4050
0907623 	0003501905 0003501905 639340 082751027		MK - NG - SK
0907556 	0003500213 0003500213 0005861433 0003500305 0003500505	l=152 p=24 D=65 d=21	LK - LN2 - NG - SK - LP
0907304 	0003500613 0003500613 0005861135 0003501805	l=152 p=24 D=70 d=21	ACTROS - MP2 - MP3 - ECONIC
0908990 	0003502605 0003502605	l=152 p=24 D=75 d=21	
0908991 	0003503105 0003503105	l=152 p=24 D=85 d=25	
0907671 	0003310017 0003310017		ACTROS - ACTROS MP2 - MP3 - ATEGO - AXOR 2 - ECONIC: 1823-1828-2628











KIT DI SOSPENSIONE - SUSPENSION KITS

RIF. OCAP OCAP REF.	RIF. ORIG O.E. NUMBER	NOTE REMARKS	MODELLO / DESCRIZIONE MODEL / DESCRIPTION
<p>0908983</p> 	<p>0003501405 0003501405</p>		

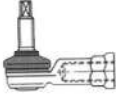

SNODI SOSPENSIONI - SUSPENSION JOINTS

RIF. OCAP OCAP REF.	RIF. ORIG O.E. NUMBER	NOTE REMARKS	MODELLO / DESCRIZIONE MODEL / DESCRIPTION
<p>0402159</p> 	<p>0003200028 6313200228 0003200028 0003200128 6083200028 6083200128 6313200028 6313200128</p>		<p>100 (Furgonato)</p>





TESTE COMANDO CAMBIO - GEAR BOX CONTROL BALL JOINTS

RIF. OCAP OCAP REF.	RIF. ORIG O.E. NUMBER	NOTE REMARKS	MODELLO / DESCRIZIONE MODEL / DESCRIPTION
0189995 	0009965245 0009965245	L=45	
0189996 	0009966845 0009966845	L=55	
0189997 	0002685989 0002685989	L=55	
0287229 	0002686289 0002686289 0002684689	L=55 M=12x1,75 RHT	1418-1424-1624-1626 - 2064-2219-2223-2224-2232 - BM335/336/ 354/355 - BM361/363/366 - LPS-NG:1219
0297229 	0002686189 0002686189 0002684789	L=55 M=12x1,75 LHT	1418-1424-1624-1626 - 2064-2219-2223-2224-2232 - BM335/336/ 354/355 - BM361/363/366 - LPS-NG:1219
0287646 	0002685589 0002685589 0002686389	L=55 M=12x1,75 RHT	BM 710- BM 717
0289998 	0009965045 0009965045	L=56 M=12x1,75 RHT	
0299998 	0009965145 0009965145	L=56 M=12x1,75 LHT	
0289999 	0009966645 0009966645	L=60 M=12x1,75 RHT	
0299999 	0009966745 0009966745	L=60 M=12x1,75 LHT	
0187228 	0002684889 0002684889 0002680189	L=85 M=14 x 1,5 RHT	BM: 335-336-354-355-361-363-366 - LP: 1624-1418-2219-1424- 2223-2224 - 1626-2064-2232-2223-2224



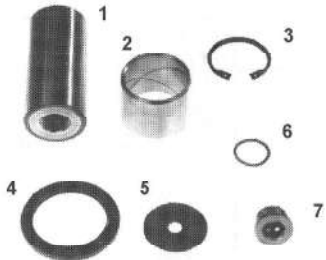

STABILIZZATORI - STABILIZERS

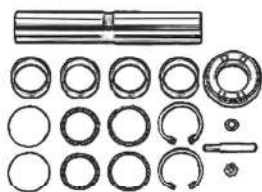
RIF. OCAP OCAP REF.	RIF. ORIG O.E. NUMBER	NOTE REMARKS	MODELLO / DESCRIZIONE MODEL / DESCRIPTION
0508968 	0003220323 0003220323	L=1815	
0508969 	0003220423 0003220423	L=1815	
0508970 	0003220223 0003220223	L=1815	

KIT PERNO FUSO - KING PIN SET

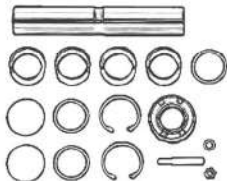
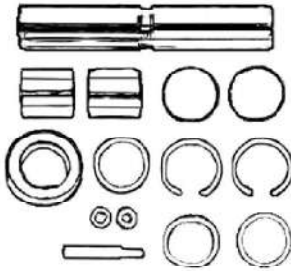
RIF. OCAP OCAP REF.	RIF. ORIG O.E. NUMBER	NOTE REMARKS	MODELLO / DESCRIZIONE MODEL / DESCRIPTION
0927409 	3463320106 3463320106	L=109 D=50	ACTROS - MP2 - MP3 - ATEGO - AXOR 2 - LK - LN2 - MK - NG - SK
0927410 	3465860133 3465860133	L=119 D=50/64	ACTROS - MP2 - MP3 - ATEGO - LK - LN2 - MK - NG - SK
0927411 	6113300019 6113300019	L=136 D=26	T1: 307D - 407D - 408D - 409D - 410D - 507D - 510 - ASSE / AXLE: - BM 730.405/407/447/448 - VARIO
0927412 	6013300019 6013300019 6015865033 6013325306	L=132 D=23	T1: 207D - 208D - 209D - 210D - 307D - 309D - ASSE / AXLE: - BM 730.403/404/445/446
0927416 	3103301219 3103301219 6683300019	L=154 D=27	406DG L/LK - 407D L/LK - 408DG L - 408G L/LF/LK/LKO - 409 L/ LK/LKO - 410 L/LK - 507D - 508DG L - 510 - 608D L - 609D - 611D O - 613D L - 613D O - 614D O - 709D - 709/K - 809D - 811D - VARIO
0927419 	6753300119 6753300119 6703300119	L=186 D=30	ACTROS-ATEGO - ECONIC:1823-1828 - LK/LN2-T2/LN1- UNIMOG U - VARIO

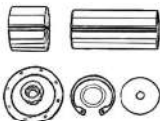
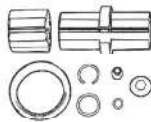
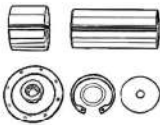

KIT PERNO FUSO - KING PIN SET

RIF. OCAP OCAP REF.	RIF. ORIG O.E. NUMBER	NOTE REMARKS	MODELLO / DESCRIZIONE MODEL / DESCRIPTION
0927420 	6753300019 6753300019 6703300219	L=186 D=30	ACTROS-ATEGO - ECONIC:1823/1828 LL - LK/LN2-T1/TN-T2/ LN1 - UNIMOG U - VARIO
0927432 	3553300319 3553300319 3555860033	L=219 D=45	1219 K - 1413 /K/KO - 1414 /K - 1417/K/KO/C/CK - 1419 /F/K/L/S/ C/CL - 1420/L/LS - 1422/F/L/LS/S - 1424/F/K/S - 1425/LS/S - 1428 F - 1613/K/KO/L - 1614/K - 1617/K/KO/L/S/C/CK/CL/CS - 1619 /K/ KO/L/S/C - 1620 /L - 1622 /K/L/S - 1624 /K/L/LS/S - 1625 /K/L/LS/ S - 1628 L - 1814 - 2219 6x2/L 6x2 - 2219 6x4 /K/KO - 2222 L - 2224 6x2/6x4 /B
0927436 	3913300019 3913300019 3915860033 3895860033	L=222,5 D=50/51	ASSE ANTERIORE/FRONT AXLE: - ACTROS - ATEGO - ATEGO 2 - ECONIC - MK - NG - SK
0927437 	3463300019 3463300019 3465860033	L=109 D=50	ASSE ANTERIORE/FRONT AXLE: - ACTROS - ACTROS MP2 - MP3 - ATEGO - ACTROS - ACTROS MP2- MP3 - ATEGO - AXOR II - LK/LN2 - MK - NG - SK
0927438 	3463300119 3463300119 3465860133	L=119 D=50/64	ASSE ANTERIORE/FRONT AXLE: - ACTROS - ACTROS MP2 - MP3 - ATEGO - AXOR II - LN/LN2 -SK
0927440 	6253300119 6253300119	L=109 D=55	ASSE ANTERIORE/FRONT AXLE: - BM 731.900/924 - ACTROS - MP2 - MP3 - ATEGO - AXOR II - MK - NG - SK - MP3
0927441 	6253300219 6253300219	L=126 D=55/60/76	ASSE ANTERIORE/FRONT AXLE: - NG - SK - ACTROS - ATEGO - AXOR II





COMPONENTI - COMPONENTS

RIF. OCAP OCAP REF.	RIF. ORIG O.E. NUMBER	NOTE REMARKS	MODELLO / DESCRIZIONE MODEL / DESCRIPTION
1216337 	9413230050 9413230050		ACTROS - ACTROS MP2/MP3 - ATEGO - AXOR 2 - ECONIC
1216338 	9423260050 9423260050		ACTROS - ACTROS MP2/MP3 - ATEGO - AXOR 2 - ECONIC
1216341 	9603232285 9603232285		ACTROS MP4 - ANTOS
1216342 	9603231085 9603231085		ACTROS MP4 - ANTOS
1216343 	9603233785 9603233785		ACTROS MP4 - ANTOS
1216344 	9603232085 9603232085		ACTROS MP4 - ANTOS - AROCS
1216345 	9603231285 9603231285		ACTROS MP4 - ANTOS
1216346 	9603172112 9603172112		ACTROS MP4 - AROCS - ATEGO
1216347 	9603172212 9603172212		ACTROS MP4 - AROCS



BARRE ACCOPPIAMENTO - TIE RODS

RIF. OCAP OCAP REF.	RIF. ORIG O.E. NUMBER	NOTE REMARKS	MODELLO / DESCRIZIONE MODEL / DESCRIPTION
<p>0506588</p>  <p>0186592 M=22x1,5 RHT </p> <p>0196592 M=22x1,5 LHT </p>	<p>11200265-0 11200265-0</p>	<p>L=1385</p>	<p>ECO T 100 35.08-35.09-35.095</p>









TIRANTI LONGITUDINALI - DRAG LINKS

RIF. OCAP OCAP REF.	RIF. ORIG O.E. NUMBER	NOTE REMARKS	MODELLO / DESCRIZIONE MODEL / DESCRIPTION
0506591 	11505036-0 11505036-0	L=755	TRADE: 2.8-3.0-100
0506590 	11200454-0 11200454-0	L=780	ECO T 100 35.08-35.09-35.095
0509411   0186592 M=22x1,5 RHT	48510-F3900 48510-F3900 48510-F3901 48510-LA21D 48510F3900 48510F3901 48510LA21D	L=640 T=36	CABSTAR

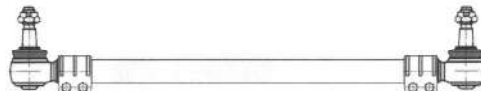



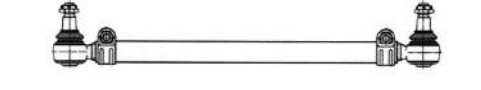

TESTE STERZO - TIE RODS END

RIF. OCAP OCAP REF.	RIF. ORIG O.E. NUMBER	NOTE REMARKS	MODELLO / DESCRIZIONE MODEL / DESCRIPTION
0186592 	11200360-0 11200360-0	L=95 m=14x1,5	L 35.08-L 35.09 - ECOT 100.35-ECOT 100.56 - TRADE-CABSTAR - ATLEON
0196592 	11200361-0 11200361-0	L=95 M=22x1,5 LHT	L 35.08-L 35.09 - ECOT 100.35-ECOT 100.56 - TRADE-CABSTAR - ATLEON



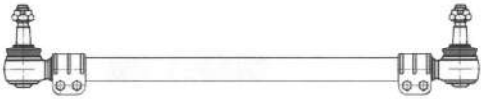



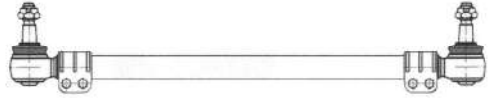

BARRE ACCOPPIAMENTO - TIE RODS

RIF. OCAP OCAP REF.	RIF. ORIG O.E. NUMBER	NOTE REMARKS	MODELLO / DESCRIZIONE MODEL / DESCRIPTION
0509912  0186424 M=30x1,5 RHT	1164684 1164684	L=825 T=42	-
0506904  0186613 M=28x1,5 RH 0196613 M=28x1,5 LH	5010097562 5010097562 5000350120 5000541224	L=1404	MIDLINER M/S
0506699  0186595 M=24x1,5 RHT 0196595 M=24x1,5 LHT	5000446681 5000446681 5010224899	L=1415	MIDLINER: M-S
0506595  0186595 M=24x1,5 RHT 0196595 M=24x1,5 LHT	5010224898 5000393080 5000393204 5000614223 5010224898	L=1420 T=30	MESSANGER
0508732 	5010566048 5010566048	L=1446	
0508733  0186424 M=30x1,5 RHT 0196424 M=30x1,5 LHT	5010308214 5010308214	L=1446	MIDLINER: M-S
0507864  0182345 M=30x1,5 RHT 0192345 M=30x1,5 LHT	5010566049 5010566049	L=1500	MIDLUM
0506697  0186424 M=30x1,5 RHT 0196424 M=30x1,5 LHT	5000613837 5000613837	L=1510	MIDLINER: M-S

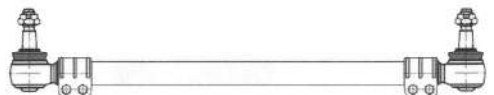

BARRE ACCOPPIAMENTO - TIE RODS

RIF. OCAP OCAP REF.	RIF. ORIG O.E. NUMBER	NOTE REMARKS	MODELLO / DESCRIZIONE MODEL / DESCRIPTION
<p>0508734</p>  <p>0186598 M=30x1,5 RHT 0196598 M=30x1,5 LHT</p>	<p>5010216608 5010216608</p>	<p>L=1516</p>	<p>PREMIUM - DITRIBUTION</p>
<p>0507865</p>  <p>0182346 M=30x1,5 RHT</p>	<p>5010439023 5010439023 5010291903 5010566062</p>	<p>L=1560</p>	<p>MIDLUM - MIDLINER: M-S</p>
<p>0508735</p>  <p>0186598 M=30x1,5 RHT 0196598 M=30x1,5 LHT</p>	<p>5010308083 5010308083</p>	<p>L=1570</p>	<p>PREMIUM - DITRIBUTION - ROUTE</p>
<p>0506754</p>  <p>0186598 M=30x1,5 RHT 0196598 M=30x1,5 LHT</p>	<p>5010308082 5010308082</p>	<p>L=1620</p>	<p>PREMIUM - KERAX</p>
<p>0507987</p>  <p>0186598 M=30x1,5 RHT 0196598 M=30x1,5 LHT</p>	<p>5010308215 5010308215 5010566058</p>	<p>L=1650 T=48</p>	<p>KERAX - MAGNUM - MIDLUM - PREMIUM 2</p>
<p>0508736</p>  <p>0187723 M=30x1,5 RHT</p>	<p>5001868363 5001868363</p>	<p>L=1655</p>	
<p>0509910</p> 	<p>7420713859 7420713859 20713859</p>	<p>L=1657 T=42</p>	<p>KERAX 370-380-410-450-460-500</p>
<p>0509911</p>  <p>0187723 M=30x1,5 RHT</p>	<p>7422163637 7422163637</p>	<p>L=1686 T=60</p>	<p>C SERIE 250P-280P-320P - PREMIUM 2 DISTRIBUTION - PREMIUM 2 ROUTE</p>









BARRE ACCOPPIAMENTO - TIE RODS

RIF. OCAP OCAP REF.	RIF. ORIG O.E. NUMBER	NOTE REMARKS	MODELLO / DESCRIZIONE MODEL / DESCRIPTION
0506695  0186598 M=30x1,5 RHT 0196598 M=30x1,5 LHT	5000786902 5000786902 5010145077 0023123224 0023123230 5001860359	L=1690	MIDLINER: M 140-M 200-M 230- M 250 - S 120-S 220 - MIDLUM
0507855  0187854 M=30x1,5 RHT 0197854 M= 30x1,5 LHT	5010566059 5010566059	L=1700	PREMIUM - KERAX
0507856  0187856 M=30x1,5 RHT	5010566064 5010566064 5010439022	L=1720	PREMIUM
0506939  0186598 M=30x1,5 RHT 0196598 M=30x1,5 LHT	5000613598 5000613598	L=1736	
0507849  0186598 M=30x1,5 RHT 0196598 M=30x1,5 LHT	5010439631 5010439631 5010098467 5010145584	L=1752	KERAX - MAJOR - MAXTER - PREMIUM
0507858  0187856 M=30x1,5 RHT	5010566063 5010566063 5010439021	L=1755	PREMIUM - DITRIBUTION - ROUTE - MAGNUM - MAGNUM AE - E. TECH - KERAX
0509435  0188994 M=30x1,5 RHT	5010630434 5010630434	L=1818 T=58	MAGNUM - PREMIUM 2
0509440  0187723 M=30x1,5 RHT	7422163636 7422163636	L=1766 T=60	MAGNUM







BARRE ACCOPPIAMENTO - TIE RODS

RIF. OCAP OCAP REF.	RIF. ORIG O.E. NUMBER	NOTE REMARKS	MODELLO / DESCRIZIONE MODEL / DESCRIPTION
0509468 	7422159764 7422159764	L=1671 T=60	SERIE T
0509473 	7422159755 7422159755 7421192770	L=1693 T=60	SERIE T

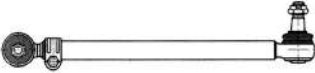

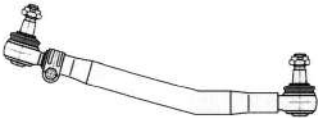



TIRANTI LONGITUDINALI - DRAG LINKS

RIF. OCAP OCAP REF.	RIF. ORIG O.E. NUMBER	NOTE REMARKS	MODELLO / DESCRIZIONE MODEL / DESCRIPTION
0508995  0186598 M=30x1,5 RHT 0196598 M=30x1,5 LHT	5010294320 5010294320	L=482	PREMIUM - DITRIBUTION - ROUTE
0507202  0186595 M=24x1,5 RHT 0196595 M=24x1,5 LHT	5000395435 5000395435 5000395296	L=495	B 70 - B 90 - MESSENGER B 110.45-120
0506689  0187891 M=38x1,5 RHT	0023123262 0023123262	L=505	BERLIET - GHB 230-260 - GLM 280-TLM 280
0507884  0187884 M=24x1,5 RH 0197884 M=24x1,5 LH	5010488464 5010488464	L=540	MASCOTT
0508997  0186598 M=30x1,5 RHT 0196598 M=30x1,5 LHT	5010130783 5010130783	L=550	MASCOTT - MANAGER - G 260
0508998 	5010630980 5010630980	L=552	KERAX - PREMIUM 2 LANDER
0508999 	5010383410 5010383410	L=570	MASCOTT
0507741  0186598 M=30x1,5 RH 0196598 M=30x1,5 LH	5430122944 5430122944 5430119888	L=603	Gamma: G - MAXTER - KERAX - (6x4) - (8x4)
0508720  0186598 M=30x1,5 RHT 0196598 M=30x1,5 LHT	5010488051 5010488051	L=625	KERAX - MAXTER





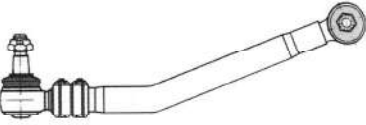

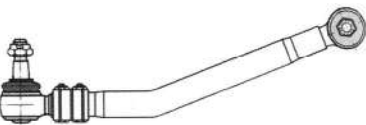

TIRANTI LONGITUDINALI - DRAG LINKS

RIF. OCAP OCAP REF.	RIF. ORIG O.E. NUMBER	NOTE REMARKS	MODELLO / DESCRIZIONE MODEL / DESCRIPTION
0508721 	5001868374 5001868374	L=700	MAGNUM
0506679  0186598 M=30x1,5 RHT	5010060764 5010060764 5010557243	L=720	Gamma: AE-EURO 2 - MAGNUM AE 420 - MAGNUM DXI - MAGNUM E.TECH
0507740  0186598 M=30x1,5 RH	5010130383 5010130383	L=725	CBH/CLM (6x6)
0508722  0186598 M=30x1,5 RHT	5010383203 5010383203	L=735	MAGNUM
0506688  0186598 M=30x1,5 RHT	5010130344 5010130344 5000932435 5010174787	L=737	AE - MAGNUM: AE - E. TECH
0507253  0186598 M=30x1,5 RHT	213123269 213123269 213123268	L=807	BERLIET: GLT 190 - CBH 200
0506681  0186598 M=30x1,5 RHT	5010294287 5010294287	L=810	PREMIUM DISTRIBUTION - PREMIUM ROUTE - PREMIUM 2 DISTRIBUTION - PREMIUM 2 ROUTE - Sospensioni anteriori meccaniche - (Mechanic suspension-front)
0508723  0187900 M=30x1,5 RHT	5010630822 5010630822	L=825	















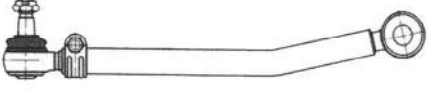

TIRANTI LONGITUDINALI - DRAG LINKS

RIF. OCAP OCAP REF.	RIF. ORIG O.E. NUMBER	NOTE REMARKS	MODELLO / DESCRIZIONE MODEL / DESCRIPTION
0506684  0186598 M=30x1,5 RHT	5010294288 5010294288	L=825	PREMIUM DISTRIBUTION - PREMIUM ROUTE - PREMIUM 2 DISTRIBUTION - PREMIUM 2 ROUTE - Sospensioni anteriori meccaniche - (Mechanic suspension-front)
0507854  0187854 M=30x1,5 RHT	5010294720 5010294720	L=840	PREMIUM ROUTE
0507755  0186598 M=30x1,5 RHT	5010064715 5010064715 5010130382 7485114932	L=830	C CBH - C CLM
0506680  0186598 M=30x1,5 RHT	5010130483 5000787472 5010130483	L=840	C 260-300-340
0506682  0186598 M=30x1,5 RHT	5010294502 5010294502	L=847	PREMIUM DISTRIBUTION - PREMIUM ROUTE
0507677  0186598 M=30x1,5 RHT	5001855163 5001855163 0023123269 0023123268	L=850	GLR 190-230 - GLC 190-230
0506685  0186598 M=30x1,5 RHT	5010294289 5010294289	L=861	PREMIUM DISTRIBUTION - PREMIUM ROUTE - PREMIUM 2 DISTRIBUTION - PREMIUM 2 ROUTE - Sospensioni anteriori pneumatiche - (Pneumatic suspension front)
0506751  0186598 M=30x1,5 RHT	5000785429 5000785429	L=870	BERLIET - GR-GC:231-291 - GF:231-291-GRH - PGC: 191-231 - GRH 235





TIRANTI LONGITUDINALI - DRAG LINKS

RIF. OCAP OCAP REF.	RIF. ORIG O.E. NUMBER	NOTE REMARKS	MODELLO / DESCRIZIONE MODEL / DESCRIPTION
<p>0506683</p>  <p>0186424 M=30x1,5 RHT</p>	<p>5010130393 5010130393</p>	L=872	MIDLINER M: 150-180-210-250 - MIDLINER S: 135-150-180-210 - C-G - KERAX - MAGNUM - PREMIUM DISTRIBUTION/ROUTE - MAXTER - MESSENGER - MASCOTT
<p>0508724</p>  <p>0186595 M=24x1,5 RHT</p>	<p>5010037411 5010037411</p>	L=877	MIDLINER
<p>0506690</p>  <p>0186424 M=30x1,5 RHT</p>	<p>5000541230 5000541230 5000352082 5000352083 5516017400 5516017831</p>	L=880	MIDLINER S: - 130-150-170
<p>0507862</p>  <p>0182344 M=28x1,5 RHT</p>	<p>5010488165 5010488165</p>	L=883	MIDLUM
<p>0507861</p>  <p>0182344 M=28x1,5 RHT</p>	<p>5010488164 5010488164</p>	L=886	MIDLUM
<p>0508725</p>  <p>0186613 M=28x1,5 RHT</p>	<p>5010557423 5010557423</p>	L=891	
<p>0508726</p> 	<p>7420761145 7420761145</p>	L=893	
<p>0507985</p>  <p>0186613 M=28x1,5 RHT</p>	<p>5010383097 5010383097 7485114938</p>	L=895 T=40	MIDLINER M: - 150-180-210-250 - MIDLINER S: - 135-140-150-160-180-210





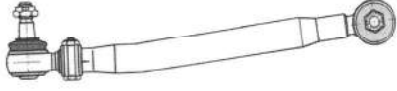

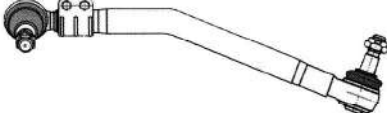
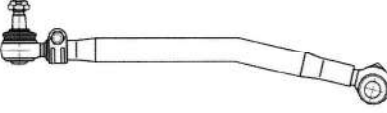









TIRANTI LONGITUDINALI - DRAG LINKS

RIF. OCAP OCAP REF.	RIF. ORIG O.E. NUMBER	NOTE REMARKS	MODELLO / DESCRIZIONE MODEL / DESCRIPTION
0508727  0186424  M=30x1,5 RHT	5010039426 5010039426	L=895	MIDLINER
0508728  0186598  M=30x1,5 RHT	5000453600 5000453600	L=902	MIDLINER
0506686  0186613  M=28x1,5 RHT	5010130456 5010130456 5010037602 5010037603 5010037418 5010130446 5010130447 5010163162 5010163163 5010163161	L=902	MIDLINER M: - 150-180-210-250 - MIDLINER S: - 120-135-140-150-160-180-210
0508730  0186598  M=30x1,5 RHT	5010229243 5010229243	L=934	KERAX - MAXTER G
0506687  0186598  M=30x1,5 RHT	5010229242 5010229242 5010488052	L=934	KERAX - MAXTER G
0507220  0186424  M=30x1,5 RHT	5010488146 5010488146	L=940 T=42	MIDLUM
0507988  0186424  M=30x1,5 RHT	5010488097 5010488097 5010383529	L=944 T=52	KERAX: 340-370-385-400-420 - MAXTER: G 300-340
0507863  0182345  M=30x1,5 RHT	5010488167 5010488167 5010305367	L=946	MIDLUM





TIRANTI LONGITUDINALI - DRAG LINKS

RIF. OCAP OCAP REF.	RIF. ORIG O.E. NUMBER	NOTE REMARKS	MODELLO / DESCRIZIONE MODEL / DESCRIPTION
<p>0506676</p>  <p>0186598 M=30x1,5 RHT</p>	<p>5010144552 5010144552 5000725267 5000787304 5010144549 5000787305 5000787306</p>	L=975	MANAGER G: 270-280-300-330-340 - MAXTER G: 230-260-280-300-340
<p>0507674</p>  <p>0186598 M=30x1,5 RHT</p>	<p>5010144554 5010144554 5000725268</p>	L=975	G G 200/210/230 TI/260/290 - G MANAGER (4x2) - G MANAGER (6x2) (6x4)
<p>0506677</p>  <p>0186598 M=30x1,5 RHT</p>	<p>5010144556 5010144556 5000745719 5000791330 5010144551 5010092170 5010092191 5010144557</p>	L=975	MANAGER G - MAXTER G
<p>0506693</p>  <p>0186424 M=30x1,5 RHT</p>	<p>5000932435 5000932435 5010174787</p>	L=985	MAGNUM AE - MAGNUM E-TECH
<p>0506642</p>  <p>0186598 M=30x1,5 RHT</p>	<p>5010130453 5010130453 0023123247 5000748868 5000874577 5000748784 5010138446 5010138060 0000712758 0000721608 5010138691 5000783889 5000874578 50101030452</p>	L=1012	R 340 - Modello unico fino a 05/93 - Dopo vedi: - 0506678-0506691 RIF.OCAP - (Only model to 05/93. - After Check For OCAP REF.: 0506678-0506691) - MAJOR R
<p>0507673</p>  <p>0186598 M=30x1,5 RHT</p>	<p>5010130451 5010130451</p>	L=1012	GR/TR 280/305 - R 310 (4x2) > 8/84 - R 310 (6X4) JSQ 8/84 - R 310/330/340/365 1984 > - R 1993 > - MAJOR J









TIRANTI LONGITUDINALI - DRAG LINKS

RIF. OCAP OCAP REF.	RIF. ORIG O.E. NUMBER	NOTE REMARKS	MODELLO / DESCRIZIONE MODEL / DESCRIPTION
0506678   0186598 M=30x1,5 RHT	5010239340 5010239340 5010130739 5010239386	L=1018	R - MAJOR R
0507765   0186598 M=30X1,5 RHT	5010130710 5010130710	L=1040	R 93> - MAJOR R
0506691   0186598 M=30x1,5 RHT	5010239387 5010239387 5010130740	L=1040	R: 310-330-340-350-365 - 370-380-390-420 - MAJOR: 340-350-380-385-420
0508731   0186598 M=30x1,5 RHT	5010488096 5010488096	L=1125	KERAX - MAXTER G
0509412   0186598 M=30x1,5 RHT	5001868383 5001868383 7421560865 5010630821 5010630820 7422163226	L=830 T=62	PREMIUM 2 SERIE C
0509439   0186598 M=30x1,5 RHT	5010557341 5010557341 5010488759 5010488639 5010488084 20818854	L=900 T=50	MIDLUM
0509460   0186598 M=30x1,5 RHT	5001868385 5001868385 5010630812 5010630813 7421560892	L=833 T=62	SERIE C,D PREMIUM 2
0509462   0186598 M=30x1,5 RHT	7421698607 7422526504 7421698607	L=900 T=52	SERIE C,K,T



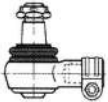

TIRANTI LONGITUDINALI - DRAG LINKS

RIF. OCAP OCAP REF.	RIF. ORIG O.E. NUMBER	NOTE REMARKS	MODELLO / DESCRIZIONE MODEL / DESCRIPTION
<p>0509463</p>  <p>0186424 M=30x1,5 RHT</p>	<p>5010630255 5010630255 5010305365</p>	<p>L=909 T=50</p>	<p>MIDLUM SERIE D</p>
<p>0509466</p>  <p>0188994 M=30x1,5 RHT</p>	<p>7422163231 7422163231</p>	<p>L=825 T=62</p>	<p>SERIE C PREMIUM 2</p>
<p>0509467</p> 	<p>7421560848 7421560848</p>	<p>L=696 T=52</p>	<p>MAGNUM</p>
<p>0509471</p> 	<p>7421560838 7421560838</p>	<p>L=697 T=50</p>	<p>MAGNUM</p>
<p>0509475</p> 	<p>7422380814 7422380814 7421698605</p>	<p>L=895 T=52</p>	<p>SERIE C - K - T</p>



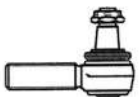
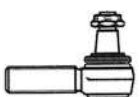



TESTE STERZO - TIE RODS END

RIF. OCAP OCAP REF.	RIF. ORIG O.E. NUMBER	NOTE REMARKS	MODELLO / DESCRIZIONE MODEL / DESCRIPTION
0287361 	5001849879 5001849879	L=75 M=26x1,5 RHT	PREMIUM DISTRIBUTION - PREMIUM ROUTE
0288930 	5001830480 5001830480	L=75 M=26x1,5 RHT	KERAX
0287360 	5001849880 5001849880	L=90 M=26x1,5 RHT	PREMIUM DISTRIBUTION - PREMIUM ROUTE
0186595 	5000814097 5000814097 5000807554 5001844136 5001860123 0003406252	L=95 M=24x1,5 RHT	B 70 - B 90 - MASCOTT - MESSENGER B - MIDLINER M - MIDLINER S
0180730 	5001836801 5001836801	L=95 M22x1,5 RHT	
0196595 	5000814096 5000814096 5000807553 5001847436 5001860769 5001858756	L=100 M=24x1,5 LHT	B 70 - B 90 - MASCOTT - MESSENGER B - MIDLINER M - MIDLINER S
0287291 	7485114029 7485114029		PREMIUM ROUTE - PREMIUM 2 DISTRIBUTION
0187884 	5001860770 5001860770	L=100 M=24x1,5 RHT	MASCOTT
0197884 	5001860769 5001860769	L=100 M=24x1,5 LHT	MASCOTT
0186613 	5000823987 5000823987 500559335 5001825687 0003406242	L=105 M=28x1,5 RHT	MIDLINER M - MIDLINER S - MESSENGER B - MIDLUM
0196613 	5000823997 5000823997 5000823947 500559336	L=105 M=28x1,5 LHT	MIDLINER M - MIDLINER S - MESSENGER B - MIDLUM

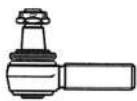
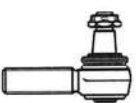
TESTE STERZO - TIE RODS END

RIF. OCAP OCAP REF.	RIF. ORIG O.E. NUMBER	NOTE REMARKS	MODELLO / DESCRIZIONE MODEL / DESCRIPTION
0182344 	- -	L=110 M=28x1,5 RHT	MIDLUM
0182345 	- -	L=115 M=30x1,5 RHT	MIDLUM
0192345 	- -	L=115 M=30x1,5 LHT	MIDLUM
0186424 	5000295214 5000295214 0003406212 0003406242 0003406253 5000242159 5000559335 5000812483 5001831473 7701016946 5001832582 5000823987	L=115 M=30x1,5 RHT	MIDLINER M: 140-210-230-250 - MIDLINER S: 120-150-170 - MIDLUM - MAGNUM
0196424 	5000295215 5000295215 0003406218 0003406213 5001850550 5001852263 5001834533	L=115 M=30x1,5 LHT	MIDLINER M: 140-210-230-250 - MIDLINER S: 120-150-170 - MIDLUM - MAGNUM
0288993 	7403193731 7403193731	L=120 M=26x1,5 RHT	PREMIUM 2 DISTRIBUTION - ROUTE
0186598 	5000288360 5000242479 5000288360 0003401169 0003406236 0003406251 0003406254 0003406260 0003406261 5000590236 5000804824 5001836298 7701011412 5010832582 5000275496 5000240688 5000242485 5000253852 5000819349 5001858773	L=120 M=30x1,5 RHT	SERIE C - SERIE R - MAGNUM AE / E. TECH - KERAX - MAJOR - MANAGER - MAXTER - MIDLINER - PREMIUM DISTRIBUTION - ROUTE

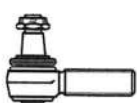
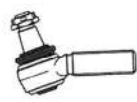

TESTE STERZO - TIE RODS END

RIF. OCAP OCAP REF.	RIF. ORIG O.E. NUMBER	NOTE REMARKS	MODELLO / DESCRIZIONE MODEL / DESCRIPTION
0196598 	5000288361 5000242478 5000288361 0003401170 5010832583 5001836297 5001832581 5001858774	L=120 M=30x1,5 LHT	SERIE C - SERIE R - MAGNUM AE / E. TECH - KERAX - MAJOR - MANAGER - MAXTER - MIDLINER - PREMIUM DISTRIBUTION - ROUTE
0187854 	- -	L=120 M=30x1,5 RHT	PREMIUM
0197854 	- -	L=120 M=30x1,5 LHT	PREMIUM
0186599 	0003401207 0003401207 5001831481 5001832580	L=120 M=38x1,5 RHT	MANAGER - MAXTER - MIDLINER
0196599 	0003401206 0003401206 5001832579	L=120 M=38x1,5 LHT	MANAGER - MAXTER - MIDLINER
0187903 	5001867774 5001867774 5001866165	L=120 M=32x1,5 RHT	KERAX - MAGNUM DXi - PREMIUM 2
0187146 	5000808458 5000808458 7701002911	L=120 M=30x1,5 RHT	
0187856 	- -	L=130 M=30x1,5 RHT	PREMIUM
0182346 	- -	L=130 M=30x1,5 RHT	MIDLUM
0287892 	5000288364 5000288364	L=130 M=48x1,5 RHT	R R 340.16/.17/.18/.22/.24/.26 - R R 350.17/.18/.24/.26 - MAJOR R - G G 260/290/320
0297892 	5000288365 5000816456 5000288365	L=130 M=48x1,5 LHT	R R 340.16/.17/.18/.22/.24/.26 - R R 350.17/.18/.24/.26 - MAJOR R - G G 260/290/320







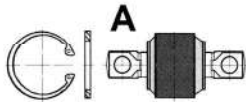
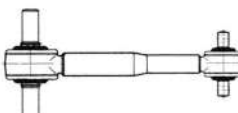
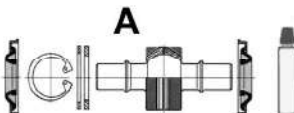

TESTE STERZO - TIE RODS END

RIF. OCAP OCAP REF.	RIF. ORIG O.E. NUMBER	NOTE REMARKS	MODELLO / DESCRIZIONE MODEL / DESCRIPTION
0187891 	0023123262 * 0023123262 *	L=130 M=38x1,5 RHT M=38x1,5 RHT	BERLIET - GHB 230-260 - GLM 280-TLM 280
0287752 	5000803464 5000803464 634300120 11100521	L=140 M=38x1,5 RHT	
0297752 	5000803465 5000803465 634300130 11100492	L=140 M=38x1,5 LHT	
0188994 	7420937674 7420937674	L=140 M=30x1,5 RHT	
0187723 	5001852452 5001852452 5001858763 50 01 852 452 50 01 858 763	L=150 M=30x1,5 RHT	C - MAGNUM - PREMIUM 2 - PREMIUM DISTRIBUTION - PREMIUM ROUTE
0287753 	5000297668 5000297668 0003401151 0003401203	L=155 M=38x1,5 RHT	
0297753 	5000297669 5000297669 0003401152 0003401202	L=155 M=38x1,5 RHT	
0197756 	5000297581 5000297581	L=157 M=30x1,5 LHT	
0187900 	5000297580 5000297580	L=157 M=30x1,5 RHT	PREMIUM 2
0287350 	5000803460 5000803460	L=167 M=52x1,5 RH	G 170/210/230/260/290 - GC 231/291 - GF 151D - TF 231D - PGC 191/231
0297350 	5000803459 5000803459	L=167 M=52x1,5 LH	G 170/210/230/260/290 - GC 231/291 - GF 151D - TF 231D - PGC 191/231
0286641 	5000288362 5000288362	L=170 M=52x1,5 RHT	R R 340.17/.18/.24/.26 - R R 350.17/.18/.24/.26 - MAJOR R

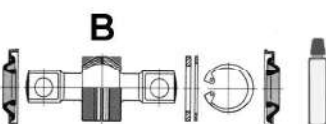

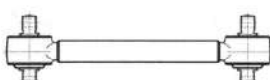



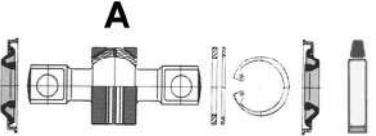
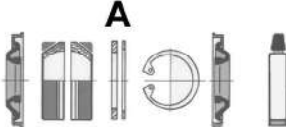

TESTE STERZO - TIE RODS END

RIF. OCAP OCAP REF.	RIF. ORIG O.E. NUMBER	NOTE REMARKS	MODELLO / DESCRIZIONE MODEL / DESCRIPTION
0296641 	5000288363 5000288363	L=170 M=52x1,5 LHT	R R 340.17/18/24/26 - R R 350.17/18/24/26 - MAJOR R
0289456 	7421431678 7421431678	L=120 M=26x1,5 RHT	SERIE C,D,T

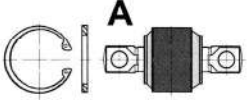

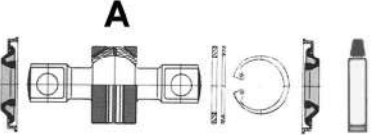

BARRE DI REAZIONE - TORQUE RODS

RIF. OCAP OCAP REF.	RIF. ORIG O.E. NUMBER	NOTE REMARKS	MODELLO / DESCRIZIONE MODEL / DESCRIPTION
0807752 	5010005937 5010005937	L=480 d=17	R312
0907749 	5000819365 5000819365 5010104365	l=122 p=24 D=62 d=17	
0807745 	0023123251 0023123251	L=490 d=19	GBH260/280...1979 - ME/ML/MD/MK 10 - MD/MK 05
0907745 	- -	L=268 P=45 D=80	-
0907746 	- -	D=80	senza perno (without pin)
0907747 	- -	l=145 p=30 D=65 d=19	
0907748 	- -	D=65	senza perno (without pin)
0807749 	5010207771 5010207771	L=490 d=17	TRACER
0907749 	5000819365 5000819365 5010104365	l=122 p=24 D=62 d=17	
0808738 	7421051052 7421051052	L=510	
0909994 	7420702095 7420702095	l=130	



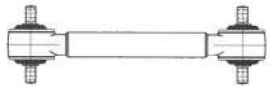
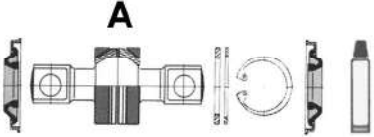
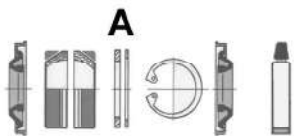

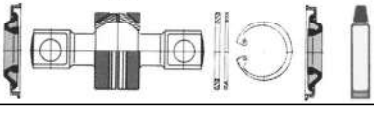
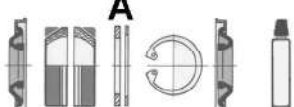

BARRE DI REAZIONE - TORQUE RODS

RIF. OCAP OCAP REF.	RIF. ORIG O.E. NUMBER	NOTE REMARKS	MODELLO / DESCRIZIONE MODEL / DESCRIPTION
0807675 	0023123275 0023123275	L=535 d=19	GRH/PRH/TRH
0907252 	5001014345 5010014345	l=145 D=65 d=19	
0907595 	5000819413 5000819413	l=145 p=30 d=19	senza perno (without pin)
0807753 	5010207726 5010207726 5000869572 5010013398	L=550 d=17	FR1.....1989
0907749 	5000819365 5000819365 5010104365	l=122 p=24 D=62 d=17	
0807674 	5010389262 5010389262	L=574 T=50	KERAX 260-270-300-320-340-370-385 - KERAX 400-410-420-450-460-500
0907219 	5001842337 5001842337	l=152 D=90 d=21	
0807551 	5000810038 5000810038 5000027957	L=565 d=19	-
0907259 	5001842823 5001842823	l=130 p=30 D=70 d=19	
0807678 	5010268035 5010268035	L=575 T=50	C CBH 320.24-320.26-320.34-385.24 - C CBH 385.26-385.34 - C CLM 320.25-385.22-385.25
0907678 	5000802123 5000802123 5001831526	l=145 p=30 D=85 d=19	





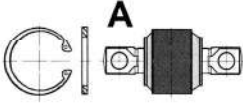
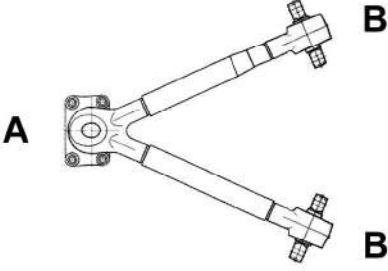
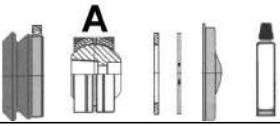
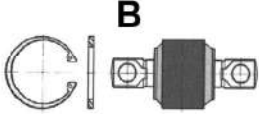

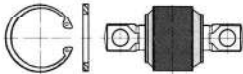
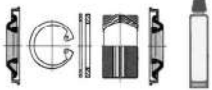

BARRE DI REAZIONE - TORQUE RODS

RIF. OCAP OCAP REF.	RIF. ORIG O.E. NUMBER	NOTE REMARKS	MODELLO / DESCRIZIONE MODEL / DESCRIPTION
0807252 	5010094941 0023123253 5010064641 5010094838 5010094941 5000783574 5000750976 5001850530 5000787496	L=575 d=19	C 300- CBH 320-385- CLM 320-385 - G 260-290 - KERAX 300-340-385-400 - MAGNUM AE - MAGNUM E.TECH - MAJOR R - MANAGER G - R: 310-330-340-350-365-370-380 - 390-420
0907252 	5001014345 5010014345	l=145 D=65 d=19	
0907595 	5000819413 5000819413	l=145 p=30 d=19	senza perno (without pin)
0807676 	5010094839 5010094839	L=575 d=21	MAXTER G 300 - G 340 - KERAX - PREMIUM
0907676 	5001823280 5001823280	l=152 d=21	
0907677 	5001823279 5001823279		Senza perno (without pin)
0807219 	5010094840 5010094840 5010467915	L=575 d=21	MAXTER G: 300-340 (6x4) (8x4) - KERAX: 300-340-385.33 (6x4) - 385.40 (8x4)-400
0907219 	5001842337 5001842337	l=152 D=90 d=21	
0907739 	5001842337 * 5001842337 *		senza perno (without pin)





BARRE DI REAZIONE - TORQUE RODS

RIF. OCAP OCAP REF.	RIF. ORIG O.E. NUMBER	NOTE REMARKS	MODELLO / DESCRIZIONE MODEL / DESCRIPTION
0807913 	7420741703 7420741703	L=662	KERAX: 370 - 410 - 450 - PREMIUM 2 LANDER
0907913 	7420741710 7420741710	D=72	
0907919 	7420547286 7420547286	D=75	
0807756 	5010207727 5010207727 5000869573 5010013397	L=692 d=17	FR1 -> 1989
0907749 	5000819365 5000819365 5010104365	l=122 p=24 D=62 d=17	
0807762 	7420829503 7420829503 7421295227	L=671 T=58 d=21	KERAX
0907762 	3090712 3090712		
0907763 	3093631 7420840815 3093630 3093631	l=130 p=30 D=85 d=21/26	
0809443 	7420448089 7420448089 20448089	L=564 l=111/115 d=17/19	MIDLUM



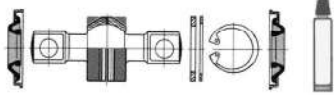
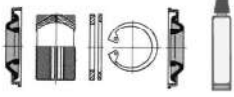
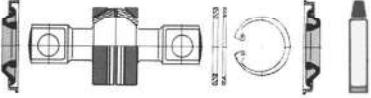

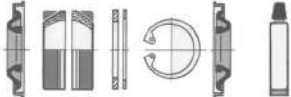
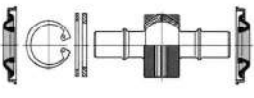
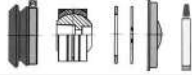
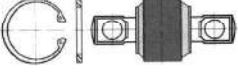

KIT DI SOSPENSIONE - SUSPENSION KITS

RIF. OCAP OCAP REF.	RIF. ORIG O.E. NUMBER	NOTE REMARKS	MODELLO / DESCRIZIONE MODEL / DESCRIPTION
0907749 	5000819365 5000819365 5010104365	l=122 p=24 D=62 d=17	R312 - MIDLINER M-S
0907746 	- -	D=80	GBH260/280...1979 - ME/ML/MD/MK 10 - MD/MK 05 - senza perno (without pin)
0907216 	7701011267 7701011267	l=130 p=30 D=65 d=19	
0907595 	5000802123 5000819413	l=145 p=30 d=19	
0907913 	7420741710 7420741710	D=72	KERAX: 370 - 410 - 450 - PREMIUM 2 - PREMIUM DISTRIBUTION - PREMIUM ROUTE
0907919 	7420547286 7420547286	D=75	KERAX: 370 - 410 - 450 - PREMIUM 2 - PREMIUM DISTRIBUTION - PREMIUM ROUTE
0907259 	5001842823 5001842823	l=130 p=30 D=70 d=19	
0907252 	5010014345 5010014345	l=145 D=65 d=19	C 300- CBH 320-385- CLM 320-385 - G 260-290 - KERAX 300- 340-385-400 - MAGNUM AE - MAGNUM E.TECH - MAJOR R - MANAGER G - R: 310-330-340-350-365-370-380 - 390-420
0907406 	5001014520 5001014520	D=65	TRACER
0907678 	5000802123 5000802123 5001831526	l=145 p=30 D=85 d=19	C CBH 320.24-320.26-320.34-385.24 - C CBH 385.26-385.34 - C CLM 320.25-385.22-385.25





KIT DI SOSPENSIONE - SUSPENSION KITS

RIF. OCAP OCAP REF.	RIF. ORIG O.E. NUMBER	NOTE REMARKS	MODELLO / DESCRIZIONE MODEL / DESCRIPTION
0907747 	- -	l=145 p=30 D=65 d=19	GBH260/280...1979 - ME/ML/MD/MK 10 - MD/MK 05
0907748 	- -	D=65	GBH260/280...1979 - ME/ML/MD/MK 10 - MD/MK 05 - senza perno (without pin)
0907219 	5001842337 5001842337	l=152 D=90 d=21	KERAX 300-320-340-370-385-400-420
0907676 	5001823280 5001823280	l=152 d=21	KERAX - MAXTER
0907677 	5001823279 5001823279		KERAX - MAXTER
0907739 	5001842337 * 5001842337 *		MAXTER G: 300-340 (6x4) (8x4) - KERAX: 300-340-385.33 (6x4) - 385.40 (8x4)-400
0907745 	- -	L=268 P=45 D=80	GBH260/280...1979 - ME/ML/MD/MK 10 - MD/MK 05
0907762 	3090712 3090712		KERAX
0907763 	3093631 7420840815 3093630 3093631	l=130 p=30 D=85 d=21/26	KERAX
0909994 	7420702095 7420702095		

STABILIZZATORI - STABILIZERS

RIF. OCAP OCAP REF.	RIF. ORIG O.E. NUMBER	NOTE REMARKS	MODELLO / DESCRIZIONE MODEL / DESCRIPTION
0509374 	7420800194 7420800194	L=275 T=30	KERAX
0587991 	5010253256 5010253256	L=280 T=28	MIDLINER M-S - MIDLUM
0597991 	5010253255 5010253255 5010238594	L=280 T=28	MIDLINER M-S - MIDLUM
0587990 	5000450713 5000450713	L=335 T=28	MIDLINER M-S - MIDLUM
0597990 	5000450714 5000450714	L=335 T=28	MIDLINER M-S - MIDLUM
0509433 	7420850454 7420850454	L=300 T=30	KERAX



TESTE COMANDO CAMBIO - GEAR BOX CONTROL BALL JOINTS

RIF. OCAP OCAP REF.	RIF. ORIG O.E. NUMBER	NOTE REMARKS	MODELLO / DESCRIZIONE MODEL / DESCRIPTION
0187228 	5010245591 5010245591 5010144543 0023162046 5000516214 5000807536	L=85 M=14 x 1,5 RH	KERAX - MAGNUM AE - MIDLUM - MAJOR R - PREMIUM DISTRIBUTION - PREMIUM 2 DISTRIBUTION - PREMIUM ROUTE - PREMIUM 2 ROUTE
0287229 	5010129530 5010129530	L=55 M=12x1,75 RH	
0297229 	5001000134 5001000134	L=55 M=12x1,75 LH	
0187346 	-	L=93 M=16 x 1,5 RH	

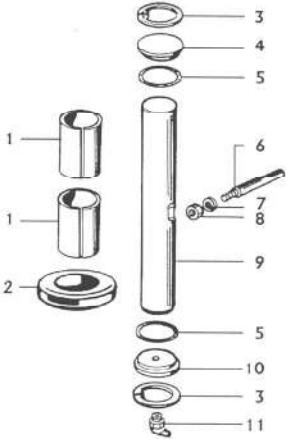
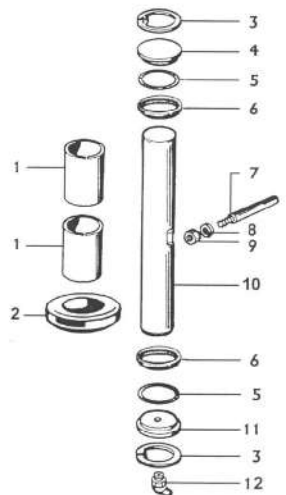
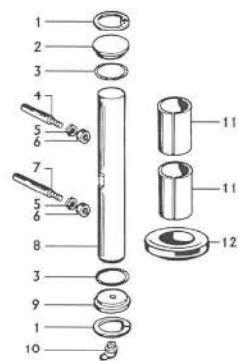
KIT PERNO FUSO - KING PIN SET

RIF. OCAP OCAP REF.	RIF. ORIG O.E. NUMBER	NOTE REMARKS	MODELLO / DESCRIZIONE MODEL / DESCRIPTION
<p>0927443</p> 	<p>5000794320 5000794320</p>	<p>L=280 D=46</p>	<p>C 260/C 290 - ASSALE/AXLE: - E6AC > 02/1987 - E6A71 02/1986 > 02/1987 - C 210/210.19 - CLR 220 - ASSALE/AXLE: - E6A4C > 02/1985 - E6A711 01/1986 > - CBH 280/340/350/380 - ASSALE/AXLE: - E6A511 > 02/1987 - CLR 190/230 - GLC 190 - ASSALE/AXLE: - E6A411 02/1982 > 02/1985 - GR 191/231 - ASSALE/AXLE: - E6A411 > 02/1982 - R 310/370/390/420 - ASSALE/AXLE: - E6A21</p>
<p>0927444</p> 	<p>5000793849 5000793849</p>	<p>L=280 D=46</p>	<p>C 260/C 290 - ASSALE/AXLE: - E6AC 03/1987 > - E6A71 03/1987 > - E6A4D 03/1984 > - C 210/210.19 - CLR 220 - ASSALE/AXLE: - E6A40 > 03/1987 - E6A711 02/1986 > - CLM 320/385 - CBH320/385 - ASSALE/AXLE: - E6A511 - E6B811 - CBH 280/340/350/380 - ASSALE/AXLE: - E6A511 03/1987 > 09/1991 - E6A811 03/1987 > 10/1991 - E6B811 10/1991 > - R310/330/340/365/RI375 - A</p>
<p>0927445</p> 	<p>5000794319 5000794319</p>	<p>L=235 D=40</p>	<p>GLR 190/230 - GLC 190 - ASSALE/AXLE: - E5A421 12/1979 > - G 260/G 290 - ASSALE/AXLE: - E5A4C - CON TAMBURO FRENO 16 " - WITH BRAKE CYL. 16" - E5A4C 02/1985 > 02/1986 - E5AC > 03/1987 - E5A821 02/1985 > 02/1986 - E5A4D > 03/1986 - E5A921 09/1984 > 03/1987 - PR 100.2/E 100.2 - ASSALE/AXLE: - TRAIN R 16 A - MAXTER</p>

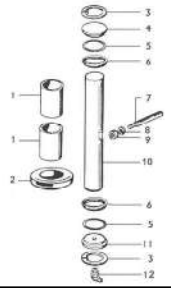
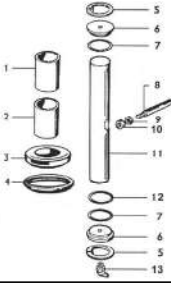
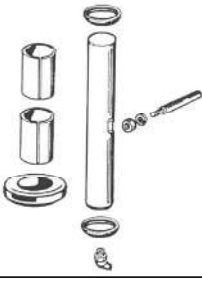

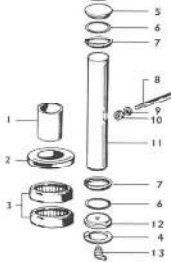









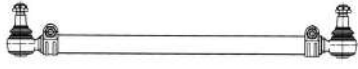



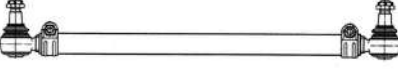

KIT PERNO FUSO - KING PIN SET

RIF. OCAP OCAP REF.	RIF. ORIG O.E. NUMBER	NOTE REMARKS	MODELLO / DESCRIZIONE MODEL / DESCRIPTION
0927446 	5000793828 5000793828	L=240 D=40	C 230/280/300/340TI/CCH300 - G 170 - G 210/230 - G 200/210/ 230 TI - G 220/270 BOM - G 230/270 SP - G 260/290 - G 320 - G 340 TI TR 18 T - PR 100-2 - PR 180-2 - M 140/160/200/230 G.B.
0907263 	5000336305 5000336305	L=178 D=35	JE 13/15 - JP 11/13 - JR 19/21 - JX 19/21 - M / S 4x4 - ME 160/180/ 210 - SE 160/180/210 - CE 160/180/210 - PS 150/160 - S 130/150 TI / 170 (VF6JP) - S 170 (FAB=SH)
0927447 	5000794318 5000794318	L=300 D=46	GR 191/232/305/350 - GBH 260/280 - GLR 190/230 - TBH 280 - TLM 280 - TR 305/350 - GLM 280 - G 45 - R 310 - PX 30
0907264 	5000793641 5000793641	L=153 D=28	JK 55/60/65/75 - M / S 150/180/210/220/230 TI/250 - MIDLINER G.B. - S 100/120/135 - S 110/130 (VF6JK) - S 135/150 (MOT. 040226) - S 140/160
0927450 	-	L=277 D=50	G 260/290 - R 370/390/420 > 1989 - AE 380/385 TI/420 TI/500/520 - PR 112/118 - PREMIUM (6x2) (6x2/4) > 1999 - PREMIUM (FAB 22E/H/J/Q/R) 2000 > - MAXTER (4x2) (4x4) (6x4) (8x4) - KERAX

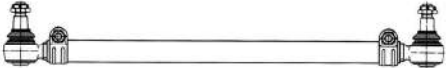

COMPONENTI - COMPONENTS

RIF. OCAP OCAP REF.	RIF. ORIG O.E. NUMBER	NOTE REMARKS	MODELLO / DESCRIZIONE MODEL / DESCRIPTION
<p>1249735</p> 	<p>7420390836 7420390836</p>	<p>L=150</p>	<p>PREMIUM-PREMIUM2-KERAX</p>





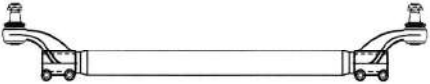

BARRE ACCOPPIAMENTO - TIE RODS

RIF. OCAP OCAP REF.	RIF. ORIG O.E. NUMBER	NOTE REMARKS	MODELLO / DESCRIZIONE MODEL / DESCRIPTION
0507780   0186598 M=30x1,5 RHT 0196598 M=30x1,5 LHT 	388943 388943	L=611	G 93/P 93/R 93 - P 113/R 113 - R 143
0507778   0186598 M=30x1,5 RHT 0196598 M=30x1,5 LHT 	395347 395347 395346	L=1595	G/P/R/T: 93 - 113 - 143
0508757   0186598 M=30x1,5 RHT	1388958 1388958	L=1625	
0507776   0186598 M=30x1,5 RHT 0196598 M=30x1,5 LHT 	283768 283768	L=1630	LB 81- LBS 86
0507779   0186598 M=30x1,5 RHT 0196598 M=30x1,5 LHT 	1363984 1363984 395348 1363964 1378436	L=1677	G/P/R/T: 93 - 113 - 143
0507777   0186598 M=30x1,5 RHT 0196598 M=30x1,5 LHT 	283766 283766	L=1731	LB 111- LBS 111-LBT 111 - LB 141- LBS 141- LBT 141
0506939   0186598 M=30x1,5 RHT 0196598 M=30x1,5 LHT 	395350 395350 301639 395432 1397866 1734020 301369 0301369 0395350 03953502 1378435	L=1736	SERIE 4: - 94-114-124 - T 114- T 124

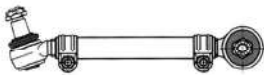





BARRE ACCOPPIAMENTO - TIE RODS

RIF. OCAP OCAP REF.	RIF. ORIG O.E. NUMBER	NOTE REMARKS	MODELLO / DESCRIZIONE MODEL / DESCRIPTION
<p>0506937</p>  <p>0186598 M=30x1,5 RHT</p>	<p>1409918 1409918 1369411 1385251 1379168 1501030 1723895 1737683 1897335 2113903 2125090 2161883</p>	<p>L=1740 T=50</p>	<p>94-114-124-144-164</p>
<p>0507725</p>  <p>0286759 M=52x1,5 RH 0296759 M=52x1,5 LH</p>	<p>310977 310977 311846 319359 0310977 03109774 3109774</p>	<p>L=1740</p>	<p>93/G/H/M/P/R/T - 113 H/M/G/P/R/T - 143 E/H/M/G/P/R/T</p>
<p>0508758</p>  <p>0187894 M=30x1,5 RHT</p>	<p>1527989 1527989</p>	<p>L=1743</p>	





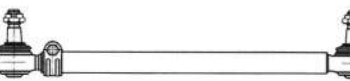





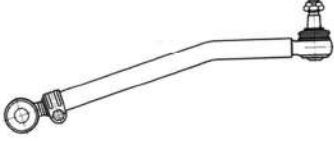



TIRANTI LONGITUDINALI - DRAG LINKS

RIF. OCAP OCAP REF.	RIF. ORIG O.E. NUMBER	NOTE REMARKS	MODELLO / DESCRIZIONE MODEL / DESCRIPTION
0507726  0186598 M=30x1,5 RH	1394884 1394884	L=420	94 C/D/G/L - 114 C/G/L - 124 G/L - 144 G/L
0507766  0187723 M=30x1,5 RHT 0196598 M=30x1,5 LHT	1343283 1343283 1356055 1759691	L=435	114C/G/L - 124C/G/L - 144C/G/L
0507767  0186598 M=30x1,5 RHT 0196598 M=30x1,5 LHT	1343266 1343266 1759690	L=495	SERIE 4: - 124 G/360 - 124 G/400 - P - G - R - T
0507727  0186598 M=30x1,5 RHT	382780 382780 0382780 382702	L=554	93- 113- 143
0507775 	388941 388941 1367628 0388941 03889417 1367641	L=554	93 M - 143 M - 113 H/M
0507188  0186598 M=30x1,5 RHT	1369917 1369917 300308 306913 382774 0382774	L=578	T 82-T 112/HK/USA - T 92-T 93MK/UK - T 113/EK/HK/US- T 142- T 143
0507999 	1343262 1343262 1869413	L=608 T=42	SERIE 4 - SERIE P-G-R-T
0507924  0186598 M30X1,5 RHT	3898707 S009593 0087932 389870	L=716 T=50	SERIE: 3



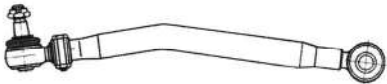





TIRANTI LONGITUDINALI - DRAG LINKS

RIF. OCAP OCAP REF.	RIF. ORIG O.E. NUMBER	NOTE REMARKS	MODELLO / DESCRIZIONE MODEL / DESCRIPTION
<p>0506846</p>  <p>0186598 M=30x1,5 RHT</p>	<p>291396 291396 291395</p>	L=728	SERIE 1: 141-143
<p>0506914</p>  <p>0186598 M=30x1,5 RHT</p>	<p>291398 291398</p>	L=761	SERIE 2: 112
<p>0507781</p>  <p>0186598 M=30x1,5 RHT</p>	<p>1300284 1300284</p>	L=765	93-113-143
<p>0507728</p>  <p>0186598 M=30x1,5 RHT</p>	<p>389867 389867 0389867 03898673</p>	L=784	SERIE 3: - 93 M- 113 E/H/M - 143 E/M/H
<p>0507737</p>  <p>0186598 M=30x1,5 RHT</p>	<p>1324483 1324483 1316872 1305012</p>	L=792	G 93 - P 93- P 93 MK- P 93 HK - P 113- P 113 EK/HK/MK - R 113- R 113 MK/EK/HK- R 143
<p>0507782</p>  <p>0186598 M=30x1,5 RHT</p>	<p>1305012 1305012 1316872 1324483</p>	L=800	93 - P 113/R 113 - 143
<p>0506936</p>  <p>0186598 M=30x1,5 RHT</p>	<p>1112511 1112511</p>	L=843	93-113-143 - Sosp. pneumatiche - (Pneumatic suspension)









TIRANTI LONGITUDINALI - DRAG LINKS

RIF. OCAP OCAP REF.	RIF. ORIG O.E. NUMBER	NOTE REMARKS	MODELLO / DESCRIZIONE MODEL / DESCRIPTION
0506913   0186598 M=30x1,5 RHT	390784 390784 0390784 03907847 306913	L=855	G 93- P 93- R 93- P 93 HK - P 113 R 113- P 113 R 113 US - P 113 R 113 HK/MK - R 143 -R 143 EK-HK
0507772   0186598 M=30x1,5 RHT	412405 412405	L=898 T=50	SERIE P-R-T
0507729   0186598 M=30x1,5 RHT	1112023 1112023	L=900	93-113-143
0507735   0186598 M=30x1,5 RH	1304569 1304569 1369919 370875	L=910	SERIE 3: - 92-93-112-113-142-143
0506919   0186598 M=30x1,5 RHT	370875 370875 1369919 1304569 0370875	L=912	82-93-112-113-143
0506869   0186598 M=30x1,5 RHT	1304571 1304571 381339	L=915	93-113-143
0506888   0186598 M=30x1,5 RHT	345124 345124	L=927	93-113-143

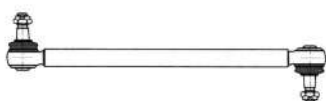



TIRANTI LONGITUDINALI - DRAG LINKS

RIF. OCAP OCAP REF.	RIF. ORIG O.E. NUMBER	NOTE REMARKS	MODELLO / DESCRIZIONE MODEL / DESCRIPTION
<p>0506829</p>  <p>0186598 M=30x1,5 RHT</p>	<p>352637 352637</p>	<p>L=947</p>	<p>93-112-113-143</p>
<p>0506889</p>  <p>0186598 M=30x1,5 RHT</p>	<p>352635 352635 278663 278664</p>	<p>L=947</p>	<p>SERIE 3: - 93-113-143</p>
<p>0506816</p>  <p>0186598 M=30x1,5 RHT</p>	<p>278665 278665 278666 0278665</p>	<p>L=947</p>	<p>82-92 - 112-142 - 93-113-143</p>
<p>0506918</p>  <p>0186598 M=30x1,5 RHT</p>	<p>306981 306981 0306981</p>	<p>L=947</p>	<p>93-113-142 - 82-92-112-142</p>
<p>0507771</p>  <p>0186598 M=30x1,5 RHT</p>	<p>1507260 1507260 1897667 482779</p>	<p>L=1044 T=60</p>	<p>SERIE K94 - L 94</p>
<p>0509881</p>  <p>0186598 M=30x1,5 RHT</p>	<p>1348269 1348269 2007275</p>	<p>L=1062 T=52</p>	<p>SERIE 4 - SERIE P-G-R-T</p>
<p>0508753</p>  <p>0186598 M=30x1,5 RHT</p>	<p>1348271 1348271</p>	<p>L=1062 T=52</p>	<p>SERIE 4 - SERIE P-G-R-T</p>
<p>0507731</p>  <p>0186598 M=30x1,4 RHT</p>	<p>1384027 1384027 1912758 1769597 1847312</p>	<p>L=1059</p>	<p>94 C/D/G/L - 114 C/G/L - 124 C/G/L - 144 - 164</p>









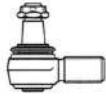

TIRANTI LONGITUDINALI - DRAG LINKS

RIF. OCAP OCAP REF.	RIF. ORIG O.E. NUMBER	NOTE REMARKS	MODELLO / DESCRIZIONE MODEL / DESCRIPTION
0506920  0186598 M=30x1,5 RHT	1379071 1379071 1384025 1356055 1847311 1912757 1768898	L=1060	SERIE 3: - 94 D/C/G/L- 114 C/G/L- 124 C/G/L- 124 L/FT800 - 144 C/G/L- 144 L/FT800 - 164 - P/G/R/T
0507764  0186598 M=30x1,5 RHT 0196598 M=30x1,5 LHT	421573 421573	L=1123	F 112/ K 112/ 112L/ S 112 - F 113/ K 113TL/ L 113/ LS 113
0507732 	388942 388942 0388942 3889425	L=1150	93 M- 113 H-M - 143
0506916 	1308643 1308643 13086434	L=1590	93-113-143
0507733 	1367628 1367628	L=1601	93 M-113 H/M-143 M
0507734 	1367641 1367641 1367641	L=1601	93 M- 113 H-M- 143 M
0507723  0187723 M=30x1,5 RHT	1395614 1395614 1361413 1734019	L=1743	SERIE 3 - 94-114-124-144
0509879 	1343264 1343264 1732635 2007278	L=1921 T=60	SERIE 4 - SERIE P-G-R-T
0509885 	1747467 1733471 1747467 2007279	L=1921 T=42	SERIE 4 - SERIE P-G-R-T
0508759 	1386618 1386618	L=2179 T=62	SERIE 4 - SERIE P-G-R-T



TIRANTI LONGITUDINALI - DRAG LINKS

RIF. OCAP OCAP REF.	RIF. ORIG O.E. NUMBER	NOTE REMARKS	MODELLO / DESCRIZIONE MODEL / DESCRIPTION
<p>0509884</p> 	<p>1343278 1343278 2007274</p>	<p>L=2783 T=60</p>	<p>SERIE 4 - SERIE P-G-R-T</p>
<p>0509416</p> 	<p>1393383 1393383 1788520</p>	<p>L=1950 T=62</p>	<p>SERIE 4 SERIE P,G,R,T</p>
<p>0509477</p>  <p>0186598 M=30x1,5 RHT</p> 	<p>2636650 2636650</p>	<p>L=1052 T=52</p>	<p>SERIE 4 SERIE P,G,R,T</p>





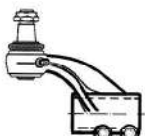





TESTE STERZO - TIE RODS END

RIF. OCAP OCAP REF.	RIF. ORIG O.E. NUMBER	NOTE REMARKS	MODELLO / DESCRIZIONE MODEL / DESCRIPTION
0187838 	325615 325615	L=75 M=	
0287361 	1394443 1394443	L=75 M=26x1,5 RHT	4 SERIES 94-114-124-144-164
0287360 	1394444 1394444	L=90 M=26x1,5 RHT	4 SERIES 114-124-144-164-94
0287684 	1375228 1375228 1912759	L=95 M=26x1,5 RHT	SERIE 3 - SERIE 4 - P-G-R-T
0186598 	283784 1358793 283784 468286 395010 1738381 0395010 1767328 0283784	L=120 M=30x1,5 RHT	82-92-112-142 - 93-113-143 - 94-114-124-144-164 - SERIE 4 - SERIE R
0196598 	283783 283783 395009 468285 1358792 1738380	L=120 M=30x1,5 LHT	82-92-112-142 - 93-113-143 - 94-114-124-144-164
0186758 	1337367 81953010022 0696226 0609643 0586714 0609634 0607073 1337367	L=135 M=30x1,5 RHT	SERIE 2: 112 - SERIE 3: 93-113-143 - T 93-T 113-T 143 - SERIE 4
0196758 	1337366 1337366 352645 325537	L=135 M=30x1,5 LH	SERIE 2: 112 - SERIE 3: 93-113-143 - T 93-T 113-T 143 - SERIE 4
0188994 	1534756 1534756	L=140 M=30x1,5 RHT	
0187894 	1723897 1723897	L=145 M=30x1,5 RHT	SERIE P - G - R - T - SERIES P - G - R - T







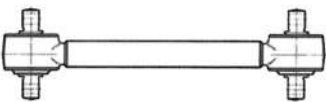

TESTE STERZO - TIE RODS END

RIF. OCAP OCAP REF.	RIF. ORIG O.E. NUMBER	NOTE REMARKS	MODELLO / DESCRIZIONE MODEL / DESCRIPTION
0187723 	1357674 1357674 1738379	L=150 M=30x1,5 RHT	SERIE 4 - P, G, R, T
0286759 	310980 310980 0310980	L=168 M=52x1,5 RH	93-113-143 - Sospensioni pneumatiche anteriori - (Pneumatic suspension front)
0296759 	310979 310979 0310979	L=168 M=52x1,5 LH	93-113-143 - Sospensioni pneumatiche anteriori - (Pneumatic suspension front)
0289455 	1394447 1394447	L=115 M=26x1,5 RHT	SERIE 4 SERIE P,G,R,T







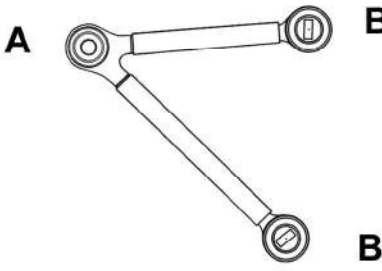
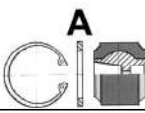

BARRE DI REAZIONE - TORQUE RODS

RIF. OCAP OCAP REF.	RIF. ORIG O.E. NUMBER	NOTE REMARKS	MODELLO / DESCRIZIONE MODEL / DESCRIPTION
0807454 	1428349 1326771 1326775 1428349	L=522 T=46 I=115	4 SERIE - P-G-R-T SERIE G - SERIE P
0907528 	639370 639370 550799 550806 0639370 1104334 112506 1517403	I=115 p=24 D=62 d=17	
0808760 	1486758 1486758	L=522 T=46 I=115	4 SERIE - P-G-R-T
0907230 	1498131 1498131	I=115	4 SERIE - P-G-R-T
0808761 	1770730 1770730	L=552 T=46 I=115	4 SERIE - P-G-R-T
0907591 	550800 550800	I=115 p=24 D=67 d=17	4 SERIE - P-G-R-T
0808762 	1486756 1486756	L=568 I=115	4 SERIE - P-G-R-T
0907230 	1498131 1498131	I=115	4 SERIE - P-G-R-T
0808763 	1499474 1499474	L=568 T=50 I=115	4 SERIE - P-G-R-T
0908763 	1722753 1722753	I=115 p=24 D=75 d=19	4 SERIE - P-G-R-T
0807771 	1399180 1399180 1338769	L=568 d=17	SERIE 3 - SERIE 4









BARRE DI REAZIONE - TORQUE RODS

RIF. OCAP OCAP REF.	RIF. ORIG O.E. NUMBER	NOTE REMARKS	MODELLO / DESCRIZIONE MODEL / DESCRIPTION
0907528 A 	639370 639370 550799 550806 0639370 1104334 112506 1517403	I=115 p=24 D=62 d=17	
0808764 A  A	1485758 1485758	L=568,5 T=46 I=115	4 SERIE - P-G-R-T
0907230 A 	1498131 1498131	I=115	4 SERIE - P-G-R-T
0808765 A  A	1500572 1500572	L=568,5 T=50 I=115	4 SERIE
0907528 A 	639370 639370 550799 550806 0639370 1104334 112506 1517403	I=115 p=24 D=62 d=17	
0808766 A  A	1499475 1499475	L=568,5 T=50 I=115	4 SERIE
0908763 A 	1722753 1722753	I=115 p=24 D=75 d=19	4 SERIE - P-G-R-T
0808767 A  A	1388436 1388436	L=568,5 T=50 I=115 d=19	SERIE 4 - SERIE P-G-R-T - SERIE P-G-R-S
0907919 A 	1515981 1515981	D=75	SERIE 4 - SERIE P-G-R-T - SERIE P-G-R-S00/560/580/620

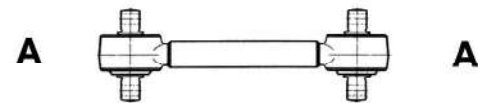

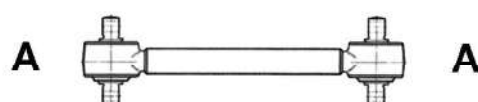

BARRE DI REAZIONE - TORQUE RODS

RIF. OCAP OCAP REF.	RIF. ORIG O.E. NUMBER	NOTE REMARKS	MODELLO / DESCRIZIONE MODEL / DESCRIPTION
0807761 	416524 416524	L=600 d=19	F 112/ K 112/ 112TL/ S 112 - F 113/K 113TL/ L 113/ LS 113
0907761 	638870 638870	D=80	
0907259 	638862 638862 639287 1104335	l=130 p=30 D=70 d=19	
0808768 	1499477 1499477	L=606 T=50 l=115 d=19	SERIE 4 - SERIE P-G-R-T - SERIE P-G-R-S
0908763 	1722753 1722753	l=115 p=24 D=75 d=19	SERIE 4 - SERIE P-G-R-T - SERIE P-G-R-S
0808769 	1399019 1399019	L=615 T=50 l=115 d=19	SERIE 4
0907528 	639370 639370 550799 550806 0639370 1104334 112506 1517403	l=115 p=24 D=62 d=17	SERIE 4
0808770 	1485760 1485760	L=616,5 T=50 l=115 d=19	SERIE 4
0908763 	1722753 1722753	l=115 p=24 D=75 d=19	SERIE 4



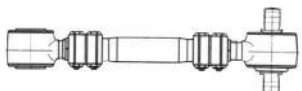
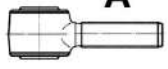
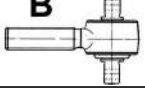
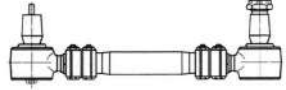
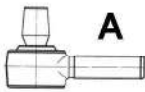
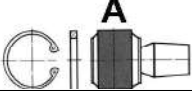
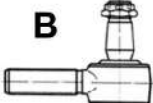

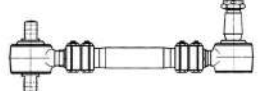

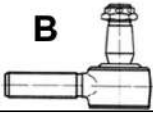

BARRE DI REAZIONE - TORQUE RODS

RIF. OCAP OCAP REF.	RIF. ORIG O.E. NUMBER	NOTE REMARKS	MODELLO / DESCRIZIONE MODEL / DESCRIPTION
0808771 	1499479 1499479	L=629 T=50 l=115 d=19	SERIE 4 - SERIE P-G-R-T - SERIE P-G-R-S
0908763 	1722753 1722753	l=115 p=24 D=75 d=19	SERIE 4 - SERIE P-G-R-T - SERIE P-G-R-S
0807738 	417290 417290	L=635 d=19	K 112- K 113
0907259 	638862 638862 639287 1104335	l=130 p=30 D=70 d=19	
0807997 	1464611 1353445 1464611 1942147	L=705 T=42 l=115	4 SERIE - SERIE P-G-R-T
0907508 	550807 550807 5508072	K=38 D=55	
0907997 	550808 550808 5508080	l=115 p=24 D=67 d=17	
0807554 	466801 466801 465816 489987	L=650 d=19	
0907259 	638862 638862 639287 1104335	l=130 p=30 D=70 d=19	
0808774 	0475087 0475087	L=654 T=40 l=115 d=17	SERIE: 114-124-K94-L94-N94

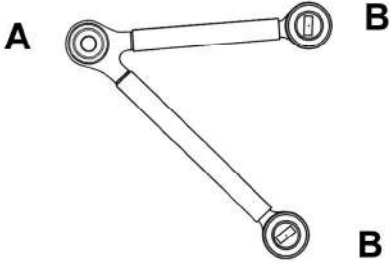

BARRE DI REAZIONE - TORQUE RODS

RIF. OCAP OCAP REF.	RIF. ORIG O.E. NUMBER	NOTE REMARKS	MODELLO / DESCRIZIONE MODEL / DESCRIPTION
0907591 A 	550800 550800	l=115 p=24 D=67 d=17	SERIE: 114-124-K94-L94-N95
0807772 A  B	445634 445634	L=667 d=19	K 113
0187772 A 	639362 639362	L=200	
0197751 B 	639361 639361	L=160	
0807759 A  B	416800 416800	L=725	F 112/ K 112/ 112 TL/ S 112 - F 113/ K 113 TL/ L 113/ LS 113
0187759 A 	638869 638869	L=160	
0907759 A 	639299 639299	D=70 K=45k	
0197523 B 	638680 638680	L=160 M=38x1,5 LHT	
0907531 B 	638861 638861	D=70 K=45	
0807758 A  B	409639 409639	L=750 d=19	F 112/ K 112/ 112 TL/ S 112 - F 113/ K 113 TL/ L 113/ LS 113
0907259 A 	638862 638862 639287 1104335	l=130 p=30 D=70 d=19	

BARRE DI REAZIONE - TORQUE RODS

RIF. OCAP OCAP REF.	RIF. ORIG O.E. NUMBER	NOTE REMARKS	MODELLO / DESCRIZIONE MODEL / DESCRIPTION
0197523 	638680 638680	L=160 M=38x1,5 LHT	
0907531 	638861 638861	D=70 K=45	
0807760 	414531 414531	L=750 d=17	SERIE 2: 112 - SERIE 3:113
0907528 	639370 639370 550799 550806 0639370 1104334 112506 1517403	l=115 p=24 D=62 d=17	
0808776 	1101843 1101843	L=752 T=48 l=115 d=17	SERIE 3 - SERIE 4 - SERIE P-G-R-T
0907591 	550800 550800	l=115 p=24 D=67 d=17	SERIE 3 - SERIE 4 - SERIE P-G-R-T
0807773 	445632 445632 445631	L=827 d=19	K 113
0907773 	639288 639288 638938	D=80	
0907259 	638862 638862 639287 1104335	l=130 p=30 D=70 d=19	







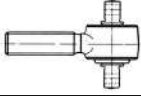
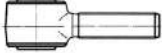



BARRE DI REAZIONE - TORQUE RODS

RIF. OCAP OCAP REF.	RIF. ORIG O.E. NUMBER	NOTE REMARKS	MODELLO / DESCRIZIONE MODEL / DESCRIPTION
<p>0809434</p> 	<p>1722582 1722582 1440028</p>	<p>L=613,2 T=46</p>	<p>SERIE P,G,R,T</p>
<p>0909434</p> 	<p>1444472 1444472</p>	<p>l=115 p=24 D=70 d=19</p>	



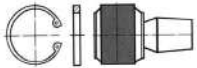



TESTE BARRE - BALL JOINTS

RIF. OCAP OCAP REF.	RIF. ORIG O.E. NUMBER	NOTE REMARKS	MODELLO / DESCRIZIONE MODEL / DESCRIPTION
<p>0197751</p> 	<p>639361 639361</p>	<p>L=160</p>	<p>K 113</p>
<p>0187772</p> 	<p>639362 639362</p>	<p>L=200</p>	<p>K 113</p>

KIT DI SOSPENSIONE - SUSPENSION KITS

RIF. OCAP OCAP REF.	RIF. ORIG O.E. NUMBER	NOTE REMARKS	MODELLO / DESCRIZIONE MODEL / DESCRIPTION
0907508 	550807 550807 5508072	K=38 D=55	4 SERIE - SERIE P-G-R-T
0907230 	1498131 1498131	l=115	4 SERIE - P-G-R-T
0907528 	639370 639370 550799 550806 0639370 1104334 112506 1517403	l=115 p=24 D=62 d=17	SERIE 2 - 3 - 4
0907591 	550800 550800	l=115 p=24 D=67 d=17	4 SERIE - P-G-R-T
0907531 	638861 638861	D=70 K=45	
0908763 	1722753 1722753	l=115 p=24 D=75 d=19	4 SERIE - P-G-R-T
0908778 	1386753 1386753	l=115 p=24 D=75 d=19	4 SERIE
0907759 	639299 639299	D=70 K=45k	
0907761 	638870 638870	D=80	
0907773 	639288 639288 638938	D=80	F 112/K 112/K 112TL/ S 112 - F 113/K 113/ K 113TL/ L 113/ LS 113
0907529 	1104336 1104336	l=152 p=35 D=80 d=32	

KIT DI SOSPENSIONE - SUSPENSION KITS

RIF. OCAP OCAP REF.	RIF. ORIG O.E. NUMBER	NOTE REMARKS	MODELLO / DESCRIZIONE MODEL / DESCRIPTION
0907259 	638862 638862 639287 1104335	l=130 p=30 D=70 d=19	K
0907405 	639319 639319 550812	l=100 D=67 d=17	4 114
0907919 	1515981 1515981	D=75	4 SERIE: 114/124/144/164/94 - P-G-R-T SERIE: 230/270/310/340/ 380/400/420/440/470/500/560/580/620
0907997 	550808 550808 5508080	l=115 p=24 D=67 d=17	SERIE 4 - SERIE P-G-R-T
0907623 	639340		
0909434 	1444472 1444472	l=115 p=24 D=70 d=19	SERIE P,G,R,T



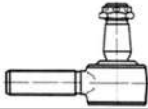
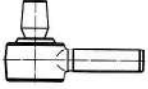



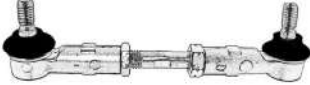

SNODI SOSPENSIONI - SUSPENSION JOINTS

RIF. OCAP OCAP REF.	RIF. ORIG O.E. NUMBER	NOTE REMARKS	MODELLO / DESCRIZIONE MODEL / DESCRIPTION
0197523 	638680 638680	L=160 M=38x1,5 LHT	F 112/ K 112/ 112 TL/ S 112 - F 113/ K 113 TL/ L 113/ LS 113
0187759 	638869 638869	L=160	F 112/ K 112/ 112 TL/ S 112 - F 113/ K 113 TL/ L 113/ LS 113





STABILIZZATORI - STABILIZERS

RIF. OCAP OCAP REF.	RIF. ORIG O.E. NUMBER	NOTE REMARKS	MODELLO / DESCRIZIONE MODEL / DESCRIPTION
<p>0509886</p> 	<p>1766014 1766014 463245</p>	<p>L=100 T=31</p>	<p>SERIE 3 - SERIE 4 - SERIE K</p>







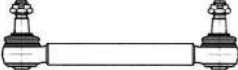

TESTE COMANDO CAMBIO - GEAR BOX CONTROL BALL JOINTS

RIF. OCAP OCAP REF.	RIF. ORIG O.E. NUMBER	NOTE REMARKS	MODELLO / DESCRIZIONE MODEL / DESCRIPTION
0507242  0287229 M=12x1,75 RHT 0297229 M=12x1,75 LHT	371453 305317 371453	L=155	93 H/M - 111- 112 H - 113 H/E/M - 141- 142-143 E/H/M - T113 - T143 - T93
0507243  0287229 M=12x1,75 RHT 0297229 M=12x1,75 LHT	371448 1427727 371448 1384896	L=260	92-112-142 - 93-113-143-94
0287229 	371452 305320 371452 1384898	L=55 M=12x1,75 RH	112-113 - 142-143 - SERIE 4: T 114 - T 124 - SERIE R
0297229 	371451 305319 371451 1384897	L=55 M=12x1,75 LH	112-113 - 142-143 - SERIE 4: T 114 - T 124 - SERIE R
0187228 	1278679 1278679 0386930	L=85 M=14 x 1,5 RH	SERIE 3
0187230 	350270 350270 243664 0350270	L=82 M=14x2 RH	SERIE 2: 112-142 - SERIE 3: 93-113-143
0187231 	1383405 1383405	L=82 M=16x2 RH	124-142-143-144
0407232 	307443 307443	M=12x1,5RH	SERIE 2: 112 H-142 - SERIE 3: 93 H/M-113 E/H/M - 143 E/H/M- T143 - T93 - SERIE 4



















KIT PERNO FUSO - KING PIN SET

RIF. OCAP OCAP REF.	RIF. ORIG O.E. NUMBER	NOTE REMARKS	MODELLO / DESCRIZIONE MODEL / DESCRIPTION
<p>0927452</p> 	<p>550732 550732 550713 550714</p>	<p>L=228 D=53,5/44,5</p>	<p>ASSALE/AXLE: AM 60 - 291311 - L-LB 81 1975 > - G-P-T 82 1980 > - LB-LBS 85 1973 > - L-LS86 1975 > - LB-LBS 86 1975 > - LB-LBS 110 1968 > - LB-LBS 111 1971 > - L-LS-LT 111 1980> - G-P-R 112 1980 > - L-LS-LB-LBS 140 1971 > - L-LS-LT-LB-LBS 141 1971 > - T-R 142 1980> - LT 146</p>
<p>0927453</p> 	<p>550730 550730 550729</p>	<p>L=215 D=44,5/55</p>	<p>ASSALE/AXLE: AM 56 - AM 61 - G 93 1986 > - P 93 1986 > - R 93 1986 > - P 113 1986 > - R 113 1986 > - R 143 1986 > - T 143 1986 ></p>
<p>0927454</p> 	<p>550257 550257</p>	<p>L=223 D=55</p>	<p>ASSALE/AXLE: AM 800/820 - 113 P/R - ASSALE/AXLE: 620/920 AMA 860 - 114 G - ASSALE/AXLE:AM/AMA 740 - AMA 860 > CH. 9014419 SAN - 4359879 SNL - 1219062 SSS - AMD 740 - AMA 860 D - 124 C/G/L - ASSALE/AXLE: AM620/920 AMA 860 - 144 G - ASSALE/AXLE: AM 740 - AM A 860 - 144 L</p>
<p>0927455</p> 	<p>550284 550284</p>	<p>L=223 D=55</p>	<p>ASSALE/AXLE: AM 800/820 - 113 P/R - ASSALE/AXLE: AM 620/920 - AMA 860 - 114 G - ASSALE/AXLE: AM/AMA 740 - AMA 860 CH. 9014420 SAN > - 4359880 SNL > - 1219063 SSS > - AMD740-AMA 860 D - 124 C/G/L - ASSALE/AXLE: AM620/920 AMA 860 - 144 G - ASSALE/AXLE: AM 740- AMA 860 - 144 L</p>









BARRE ACCOPPIAMENTO - TIE RODS

RIF. OCAP OCAP REF.	RIF. ORIG O.E. NUMBER	NOTE REMARKS	MODELLO / DESCRIZIONE MODEL / DESCRIPTION
0507224 	3112050 3112050 9959151 20497798	L=300	
0507709  0186613 M=28x1,5 RHT 0196613 M=28x1,5 LHT	6853511 6853511	L=1407	F 4 - F 607-608-609-610
0507716  0186959 M=30x1,5 RHT 0186959 M=30x1,5 LHT	1571862 1571862 1606276	L=1557	FL 616-617
0507109  0186959 M=30x1,5 RHT 0196959 M=30x1,5 LHT	1626494 1626494 1505855 1606274 1611864 16264947	L=1592	B 56 - F 7-10-12-16 - FL 6-7-10-12 - FS 7-10 - N 7-10-12 - NL 10-12
0507975  0186598 M=30x1,5 RHT 0196598 M=30x1,5 LHT	20830369 20830369 3099230	L=1607 T=40	FL 6 FL 615
0509916  0189896 M=30x1,5 RHT	21260274 21260274	L=1634 T=50	FH 12-FL 6-FM 7-FM 9-FM 10-FM 12
0509356  0187686 M=30x1,5 RHT	20361568 20361568	L=1639 T=50	FL6
0507708  0186960 M=30x1,5 RHT 0196960 M=30x1,5 LHT	1080792 1080792 6862225	L=1640	F 7-F 10 - F 12-F 16 - FL 7-FL 10 - FL 12















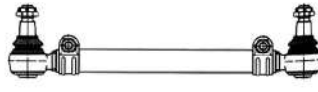



BARRE ACCOPPIAMENTO - TIE RODS

RIF. OCAP OCAP REF.	RIF. ORIG O.E. NUMBER	NOTE REMARKS	MODELLO / DESCRIZIONE MODEL / DESCRIPTION
0509896   0189896 M=30x1,5 RHT	20393097 1612254 3985570 20393097 1606897 21260286	L=1640 T=58	F 12-F 16-FH 12-FH 16-FL 6-FL 7-FL 10 - FM 7-FM 10-FM 12
0509357   0187686 M=30x1,5 RHT	20392778 20392778	L=1645 T=50	FM6-FH16
0507124   0186946 M=30x1,5 RHT 0196946 M=30x1,5 LHT 	3962343 3962343 1626637 3988711 3986454 1412254 3986450	L=1645	FH 12/16 - FL 4-FM 7/9/10/12/16 - NH 12/16
0509358   0189896 M=30x1,5 RHT	21260275 21260275	L=1660 T=62	FH12-FH16-FM12-FM9
0509359   M=30x1,5 RHT	20587731 20587731	L=1660 T=60	
0509914   0189914 M=30x1,5 RHT 0199914 M=30x1,5 LHT 	20581086 20581086 7420581086	L=1669 T=42	FH 12 - FH 16 - FH 400-420-440-460-500-520-540 - FM 12 - FM
0509900   0186959 M=30x1,5 RHT 0196959 M=30x1,5 LHT 	8156123 8156123	L=1674 T=42	FH 12 - FM16
0509911   0187723 M=30x1,5 RHT	22163637 22163637	L=1686 T=60	FE II FE 240-260-280-300-320-340



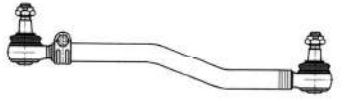

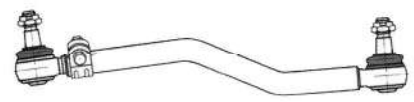



BARRE ACCOPPIAMENTO - TIE RODS

RIF. OCAP OCAP REF.	RIF. ORIG O.E. NUMBER	NOTE REMARKS	MODELLO / DESCRIZIONE MODEL / DESCRIPTION
0509894   0187686 M=30x1,5 RHT	20399543 20399543 21299034 85115631 7420399543	L=1818 T=52	FH 12 - FH 16 - FM 9 - FM12
0509436 	22159757 22159757	L=1818 T=52	FH 12-FH 16-FM 12
0509437 	22159765 22159765 21367010	L=1818 T=48	FH 16 FMX II
0509468 	21261985 21261985 22159764	L=1671 T=60	FH 16 FMX II
0509472   0187686 M=30x1,5 RHT	22159758 22159758	L=1025 T=48	FH 12-16 FM 9-12 FMX-FMX II
0509473 	22159755 22159755 21192770	L=1693 T=60	FH 16 FMX II







TIRANTI LONGITUDINALI - DRAG LINKS

RIF. OCAP OCAP REF.	RIF. ORIG O.E. NUMBER	NOTE REMARKS	MODELLO / DESCRIZIONE MODEL / DESCRIPTION
0508784  	20367555 20367555	L=160	FH12-FH16-FM - FMX
0508789   0187686 M=30x1,5 RHT	20374831 20374831	L=563 T=48	FH12-FH16-FM9-FM12
0507702   0186946 M=30x1,5 RHT	1088985 1088985 20393083	L=572	FH 12 - FH 16 - FM 7 - FM 10 - FM 12 - NH 12
 0196946 M=30x1,5 LHT			
0507713   0186960 M=30x1,5 RHT	6866174 6866174	L=610	F 7 (8x2) (8x4) - F 10- F 12
0507714   0186960 M=30x1,5 RHT	6866175 6866175	L=644	F 7 (8x2) (8x4)
0507706   0186960 M=30x1,5 RHT	1612781 1612781 1130567	L=702	F 12/16 - FL 7/10/12
 0186960 M=30x1,5 LHT			
0507245   0186960 M=30x1,5 RHT	1588018 1588018 1577081	L=738	N 7 (4x2) (6x2) (6x4) - N 10 (4x2) (6x2) (6x4) - N 12 - NL 10 - NL 12
0506965   0186960 M=30x1,5 RHT	1626493 1626493 1588263 1606277 1584620	L=740 T=40	F 10/12/16 - FL 7/12 - N 7/10 - NL 10/12

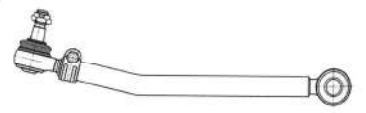





TIRANTI LONGITUDINALI - DRAG LINKS

RIF. OCAP OCAP REF.	RIF. ORIG O.E. NUMBER	NOTE REMARKS	MODELLO / DESCRIZIONE MODEL / DESCRIPTION
0506966  0186960 M=30x1,5 RHT	1588017 1588017 1626492 1505857 1577080	L=745	N 7-10-12 - NL 10-12
0507720  0186960 M=30x1,5 RHT 0196960 M=30x1,5 LHT	1094334 1094334 1575690	L=750	F 10 (8x4) - FL 10
0507119  0186960 M=30x1,5 RHT	1094912 1094912	L=762	FL 10 (6x4)
0507222  0186946 M=30x1,5 RHT	3112122 3112122 9959153 20497800	L=763	FL 7 - FL 10
0509893  0186960 M=30x1,5 RHT	1094219 1094219 20453027	L=813 T=60	FL 10 - FL 12
0508792  0186424 M=30x1,5 RHT	1071170 1071170	L=821	FL6
0507117  0186424 M=30x1,5 RHT	1071169 1071169	L=821	FL 608-611
0507680  0186960 M=30x1,5 RHT 0196960 M=30x1,5 LHT	1626672 1626672 1194824	L=822	FL 7-FL 10- FL 12

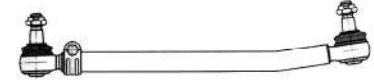





TIRANTI LONGITUDINALI - DRAG LINKS

RIF. OCAP OCAP REF.	RIF. ORIG O.E. NUMBER	NOTE REMARKS	MODELLO / DESCRIZIONE MODEL / DESCRIPTION
0507101  0186960 M=30x1,5 RHT	1592939 1592939 15929391	L=823	F 7 (8x4) - FL 6-7 - FL 10 (4x2) (8x4)- FL 12 - FS 10
0507100  0186960 M=30x1,5 RHT	1592940 1592940 15929409	L=823	F 7 (8x4) - FL 7-FL 10 (4x2) (8x4) U.K. - FL 12
0508793  0187686 M=30x1,5 RHT	20375787 20375787	L=824	FH12-FH16-FM-FM9-FM12
0508723  0187900 M=30x1,5 RHT	20727843 20727843	L=825	FE II
0507105  0186960 M=30x1,5 RHT	1080788 1080788 1608954	L=835	F 12
0507693  0186960 M=30x1,5 RHT	1083744 1083744	L=840	F 10-F 12- F 16
0507718  0186960 M=30x1,5 RHT	1626670 1626670 1611880 16266702	L=848	FL 7 (8x2) (8x4) - FL 10-FL 12
0508794  0186960 M=30x1,5 RHT	1610338 1610338	L=845	FH12-FH16-FM-FM9-FM12





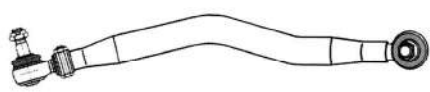



TIRANTI LONGITUDINALI - DRAG LINKS

RIF. OCAP OCAP REF.	RIF. ORIG O.E. NUMBER	NOTE REMARKS	MODELLO / DESCRIZIONE MODEL / DESCRIPTION
0506967  0186960 M=30x1,5 RHT	1626751 1626751 1610338	L=850	F 10-F 12-F 16 - FH 12-FH 16
0507104  0186960 M=30x1,5 RHT	1626750 1626750 1610074	L=850	F 10 -F 12 -F 16
0507114  0186960 M=30x1,5 RHT	1080786 1080786 1592959	L=856	F 12-FL 7-FL 10- FL 12
0507106  0186960 M=30x1,5 RHT	1080787 1080787 1608953	L=860	F 12
0508795  0186959 M=30x1,5 RHT	3988764 3988764	L=868	FH12-FH16-FM10-FM12-FM7-FM9
0508796  0186959 M=30x1,5 RHT	3988767 3988767	L=868	FH12-FH16-FM10-FM12-FM7-FM9
0506968  0186960 M=30x1,5 RHT	1613562 1613562 1626749	L=880	F 10-F 12-F 16 - Sospensione anteriore Pneumatica - (Pneumatic suspension front)
0507111  0186946 M=30x1,5 RHT	1075663 1075663 3988704 20393069	L=861	EM 12 - FH 12-FH 16 - FL 4 - FM 7-FM 10-FM 12 - - Sospensioni meccaniche anteriori - Daltelaio nr.136426 - (Mechanic suspension front - Starting from chassis nr.136426)

















TIRANTI LONGITUDINALI - DRAG LINKS

RIF. OCAP OCAP REF.	RIF. ORIG O.E. NUMBER	NOTE REMARKS	MODELLO / DESCRIZIONE MODEL / DESCRIPTION
0507120  0186946 M=30x1,5 RHT	1075664 1075664 3988701 20393063	L=861	FH 12 - FH 16 (Ultima serie-Last chassis) - FL 4 - FM 7/9/10/12/16
0507688  0186946 M=30x1,5 RHT	20393069 20393069 1075663 3988704	L=861	FH 12-FH 16 - FM 7-FM 10-FM 12 - FL 4
0507107  0186946 M=30x1,5 RHT	1075005 1075005	L=863	FH 12- FH 16 - Sospensioni meccaniche anteriori - Fino al telaio nr.136425 - (Mechanic suspension front - Up to chassis nr.136425)
0509897  0186959 M=30x1,5 RHT	20393186 20375555 20393186 21106930 22159733 3986452	L=863 T=52	FH12-FH16-FH-FM7-FM9-FM10-FM12 - FM-FMX
0509895  0187686 M=30x1,5 RHT	20393187 20393187 21106952 20375556 21406952	L=863 T=52	FH - FH 12 - FH 16 - FM - FM 7 - FM 9 - FM 10 - FM 12
0507108  0186946 M=30x1,5 RHT	1075006 1075006	L=863	F 12-F 16 - FH 12-FH 16 - FL 4-FM 7-FM 12 - Sospensioni meccaniche anteriori - (Mechanicsuspension front)
0507717  0186948 M=30x1,5 RHT	6790473 6790473	L=867	FL 616-617
0507681  0186948 M=30x1,5 RHT	6790474 6790474	L=867	F 4-F 7-F 12-F 16 - FL 616-617









TIRANTI LONGITUDINALI - DRAG LINKS

RIF. OCAP OCAP REF.	RIF. ORIG O.E. NUMBER	NOTE REMARKS	MODELLO / DESCRIZIONE MODEL / DESCRIPTION
0509891  0186959 M=30x1,5 RHT	20393079 3988708 1628635 20393079 3988710	L=869 T=50	FH 12 - FH 16 - FM 7 - FM 10 - FM12 - NH 12
0506969  0186960 M=30x1,5 RHT	1606283 1606283 1576092	L=870	F 10- F 12- F 16
0507102  0186960 M=30x1,5 RHT	1606284 1606284 1576093	L=870	F 10-F 12- F 16
0507712  0186424 M=30x1,5 RHT	6876948 6876948	L=870	F 6 (611-612-613-314)
0507118  0186424 M=30x1,5 RHT	1071344 1071344 20400944 3127737	L=871	FL 6-FL 12
0507115  0186424 M=30X1,5 RHT	6790572 6790572 67905729 20400941	L=871	FL 6
0507802  0186424 M=30x1,5 RHT	6790607 6790607 6790766 67906073 20400942	L=871	FL 6
0508797  0186959 M=30x1,5 RHT	1629397 1629397	L=875	

















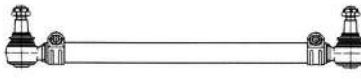

TIRANTI LONGITUDINALI - DRAG LINKS

RIF. OCAP OCAP REF.	RIF. ORIG O.E. NUMBER	NOTE REMARKS	MODELLO / DESCRIZIONE MODEL / DESCRIPTION
0507112   0186946 M=30x1,5 RHT	1075153 1075153 3988695 3988697 20303061 20393061 3090727	L=881	F 10 - FH 12- FH 16- FL 4 - FM 7/9/10/12 - Sospensioni pneumatiche anteriori - (Pneumatic suspension front)
0507113   0186946 M=30x1,5 RHT	1628636 1628636 1075153 3988695 3988697	L=881	FH 12/16 - Sospensioni pneumatiche anteriori - (Pneumatic suspension front)
0508798   0186946 M=30x1,5 RHT	3988698 3988698	L=881	
0508799   0187686 M=30x1,5 RHT	20390745 20390745	L=885	
0508800   0186959 M=30x1,5 RHT	8190146 8190146	L=888	
0509350   0186959 M=30x1,5 RHT	8190147 8190147	L=888	
0509351   0187783 M=30x1,5 RHT	20376808 20376808	L=890	
0507121   0186948 M=30x1,5 RHT	6799189 6799189 67991893 3124962	L=893	FL 6













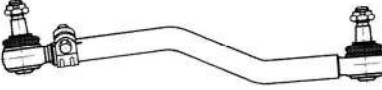

TIRANTI LONGITUDINALI - DRAG LINKS

RIF. OCAP OCAP REF.	RIF. ORIG O.E. NUMBER	NOTE REMARKS	MODELLO / DESCRIZIONE MODEL / DESCRIPTION
0509902  0186948 M=30x1,5 RHT	6799190 6799190	L=893 T=40	FL 6
0507769  0186613 M=28x1,5 RHT	6852195 6852195	L=900	F 607-608-609-610 - CH.578...2117
0507768  0186595 M=24X1,5 RHT	6852196 6852196	L=900	F 4-F 408
0507710  0186613 M=28x1,5 RHT	6852197 6852197	L=900	F 4 F-F 408 - F 607-608-609-610 - B 6 F- B 6 FA
0507122  0186948 M=30x1,5 RHT	1071315 1071315	L=910	FL 6 - FL 18
0509352  0186948 M=30x1,5 RHT	85114187 85114187	L=910	
0509353  0186960 M=30x1,5 RHT	8154444 8154444	L=934	
0507103  0186960 M=30x1,5 RHT	1606282 1606282 1587489 1576816	L=940	F 7 (4x2-6x2-6x4) - F 10- F 12

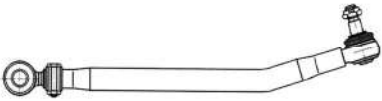







TIRANTI LONGITUDINALI - DRAG LINKS

RIF. OCAP OCAP REF.	RIF. ORIG O.E. NUMBER	NOTE REMARKS	MODELLO / DESCRIZIONE MODEL / DESCRIPTION
0507863   0182345 M=30x1,5 RHT	20709844 20709844	L=946	FL - FL II
0507116   0186612 M=24x1,5 RHT	3124480 3124480 20400909 31244809 3124594 6777855 6791948	L=978	F 6 - FE 6 - FL 6 (608-611)
0507683   0186960 M=30x1,5 RHT	8132373 8132373	L=1022 T=62	
0507244   0186960 M=30x1,5 RHT	1135630 1135630 1127452	L=1106	B 9 M- B 10 MK1
0507679   0186960 M=30x1,5 RHT	1134840 1134840	L=1114	B 9 M- B 10 M
0507715   0186612 M=24x1,5 RHT 0196612 M=24x1,5 LHT 	6771120 6771120 67711200 20400907	L=1556	FL 4 FL 408 - FL 6 FL 608-611 - FLC 140
0507707   0186424 M=30x1,5 RHT 0196424 M=30x1,5 LHT 	6771112 6771112	L=1582	FE 6-FL 6
0507895   0186960 M=30x1,5 RHT	1626671 1626671 1613351 1599175	L=1799	FL 10 - Per veicoli con guida a destra - For RHD vehicles only











TIRANTI LONGITUDINALI - DRAG LINKS

RIF. OCAP OCAP REF.	RIF. ORIG O.E. NUMBER	NOTE REMARKS	MODELLO / DESCRIZIONE MODEL / DESCRIPTION
0507704   0186960 M=30x1,5 RHT	1612857 1612857	L=1804	FL 7 - FL 10
0507703   0186960 M=30x1,5 RHT	1612779 1612779 3962768	L=1884	FL 7-10-12
0509360   0189360 M=38x1,5 RHT	20453063 20453063	L=2139	FH12-FH16-FH-FH II-FM9-FM12-FM
0509361 	20393093 20393093	L=2140	
0509898   0186946 M=30x1,5 RHT	24425660 20393091 20442113 20513951 24425660	L=2140 T=52	FH12 - FM12
0507705   0186960 M=30x1,5 RHT	1612858 1612858	L=2204	FL 7 - FL 10
0509412 	20727840 20727840 21560865 21560868	L=830 T=62	FE - FE II
0509439   0186598 M=30x1,5 RHT	20818854 20818854	L=900 T=50	FL - FL III
0509441 	24425658 24425658 20393089 20442111 20513949	L=2111 T=52	FM 12









TIRANTI LONGITUDINALI - DRAG LINKS

RIF. OCAP OCAP REF.	RIF. ORIG O.E. NUMBER	NOTE REMARKS	MODELLO / DESCRIZIONE MODEL / DESCRIPTION
0509460 	22163222 20727850 21560892 21560894	L=833 T=62	FE-FE II
0509462 	22526504 22526504 23341677 21698607 21543888	L=900 T=52	FH 16 FMX II
0509463   0186424 M=30x1,5 RHT	20818840 20818840	L=909 T=50	FL - FL II - FL III
0509465   0187686 M=30x1,5 RHT	22159741 22159741	L=563 T=46	FH 12 FMX
0509466   0188994 M=30x1,5 RHT	22163223 22163223	L=825 T=62	FE - FE II
0509475 	22380814 22380814 22526506	L=895 T=52	FH16 - FMX II

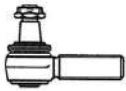
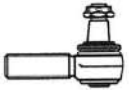









TESTE STERZO - TIE RODS END

RIF. OCAP OCAP REF.	RIF. ORIG O.E. NUMBER	NOTE REMARKS	MODELLO / DESCRIZIONE MODEL / DESCRIPTION
0287457 	1624093 1624093 1607483	L=85 M=22x1,5 RHT	F 12 - F 16 - FL 7 - FL 10
0288779 	20374698 20374698	L=88 M=26x1,5 RHT	FH12-FH16-FL6-FM12-FM7-FM9-FH-FMX
0289923 	3099128 1271126 42538048 82953016019 81953016268 82953016018 3099128 3090291	L=90 M=36x1,5 RHT	FH12-FH16-FL10-FL12-FM12
0186595 	1518142 1518142 1517449 1517452 1190778	L=95 M=24x1,5 RHT	F 10 - F 12 - F 406-F 408 - FL 7-FL 10 - FH 16
0196595 	1517448 1517448	L=95 M=24x1,5 LHT	F 10 - F 12 - F 406-F 408 - FL 7-FL 10 - FH 16
0287684 	1606980 1606980	L=95 M=26x1,5 RHT	FL 10 - F16
0287458 	8151876 8151876	L=100 M=26x1,5 RHT	FH12 - FH16 - FM7 - FL10 - FL12 - FL7 - FM10 - FM12 - FM7 - NH12
0186613 	1698191 1698191 1517440 1517444	L=105 M=28x1,5 RHT	F 6 (607-608-609-610-611-613-614) - F 406-F 407-F 408 - FL 4-FL 408
0196613 	1698190 1698190 1517279 1517439 1695511 1998190	L=105 M=28x1,5 LHT	F 6 (607-608-609-610-611-613-614) - F 406-F 407-F 408 - FL 4-FL 408
0186612 	1696919 1696919	L=105 M=24x1,5 RHT	FL 4-FL 408 - FL 6-608-611-612-614 - FLC 140
0196612 	1696920 1696920	L=105 M=24x1,5 LHT	FL 4-FL 408 - FL 6-608-611-612-614 - FLC 140





TESTE STERZO - TIE RODS END

RIF. OCAP OCAP REF.	RIF. ORIG O.E. NUMBER	NOTE REMARKS	MODELLO / DESCRIZIONE MODEL / DESCRIPTION
0186424 	1697247 1697247 1695690 1696057 1517577	L=115 M=30x1,5RHT	B 6-F 6 - FL 6
0196424 	1698839 1698839 1695689 1517647	L=115 M=30x1,5 LHT	B 6-F 6 - FL 6
0187959 	85112073 85112073	L=115 M=30x1,5 RHT	
0186946 	3090727 3090727 3110002 3988965 3090472	L=115 M=30x1,5 RHT	F 12-F 16 - FH 12- FH 16 - FM 7- FM 9-FM 10-FM 12 - NH 12
0196946 	3090728 3090728 3110001 3988968	L=115 M=30x1,5 LHT	F 12-F 16 - FH 12- FH 16 - FM 7- FM 9-FM 10-FM 12 - NH 12
0288993 	3193731 3193731	L=120 M=26x1,5 RHT	
0186948 	1698047 1698047 1697246 1506269	L=120 M=30x1,5 RHT	F 4-F 6-F 7-F 10-F 12-F 16 - FE 615 - FL 4-FL 6- FL 7-FL 10-FL 12 - FS 7
0186959 	1698846 1698846 1505759 1507823 1698532	L=120 M=30x1,5 RHT	F 7-F 10-F 12-F 16 - FH 12-FH 16 - FL4-FL 6-FL 7-FL 10 - FL 12- FL 616- FL 617 - FM 7-FM9-FM 10-FM 12 - N 7- N 10- N 12-NH 12 - NL 10- NL 12 - FS 7
0196959 	1698847 1698847 1505758 1507822 1698533 3092471 3110011 366757 6884001	L=120 M=30x1,5 LHT	F 7-F 10-F 12-F 16 - FH 12-FH 16 - FL4-FL 6-FL 7-FL 10 - FL 12- FL 616- FL 617 - FM 7-FM9-FM 10-FM 12 - N 7- N 10- N 12-NH 12 - NL 10- NL 12 - FS 7
0186960 	1695776 1695776 1507826 1695585 1698557 619687 0356310 6882111	L=120 M=30x1,5 RHT	F 6-F 7-F 10-F 12-F 16 - FL 7-FL 10-FL 12 - N 7-N 10-N 12 - NL 10- NL 12 - FM 7/10/12











TESTE STERZO - TIE RODS END

RIF. OCAP OCAP REF.	RIF. ORIG O.E. NUMBER	NOTE REMARKS	MODELLO / DESCRIZIONE MODEL / DESCRIPTION
0196960 	1698840 1698840 1131744 1698558 6869744 1313744 6882112	L=120 M=30x1,5 LHT	F 6-F 7-F 10-F 12-F 16 - FL 7-FL 10-FL 12 - N 7-N 10-N 12 - NL 10- NL 12 - FM 7/10/12
0186598 	20742127 20742127	L=120 M=30x1,5 RHT	
0196598 	20745042 20745042	L=120 M=30x1,5 LHT	
0189360 	3097999 3097999	L=120 M=38x1,5 RHT	
0189914 	20581089 20581089	L=136 M=30x1,5 RHT	FH 12 - FH 16 - FH 400-420-440-460-500-520-540 - FM 12 - FM - FMX
0199914 	20710008 20710008	L=136 M=30x1,5 LHT	FH 12 - FH 16 - FH 400-420-440-460-500-520-540 - FM 12 - FM - FMX
0188994 	20937674 20937674	L=140 M=30x1,5 RHT	
0187783 	3093714 3093714	L=140 M=30x1,5 RHT	
0187686 	3093647 3093647 21263821	L=140 M=30x1,5 RHT	FH12-FH16-FM7-FMX-FH2-FM-FM9-NH12
0189896 	3097228 21263974 3099529 3097228 3092189	L=145 M=30x1,5 RHT	F 12-F 16-FH 12-FH 16-FL 6-FL 7-FL 10-FM 7-FM 10-FM 12
0187723 	20894438 20894438	L=150 M=30x1,5 RHT	FE II







TESTE STERZO - TIE RODS END

RIF. OCAP OCAP REF.	RIF. ORIG O.E. NUMBER	NOTE REMARKS	MODELLO / DESCRIZIONE MODEL / DESCRIPTION
0187900 	5000297580 5000297580	L=157 M=30x1,5 RHT	FE II
0286964 	1699401 1699401 1131742 1696901	L=168 M=52x1,5 RHT	F 7-F 10-F 12-F 80 - FH 12- FH 16 - FL 7-FL 10- FL 12 - FM 7-FM 10-FM 12 - N 7-N 10
0296964 	1699400 1699400 1131741 1696900	L=168 M=52x1,5 LHT	F 7-F 10-F 12-F 80 - FH 12- FH 16 - FL 7-FL 10- FL 12 - FM 7-FM 10-FM 12 - N 7-N 10
0289456 	21431678 21431678	L=120 M=26x1,5 RHT	FE II - FMX II





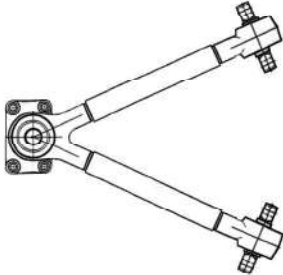
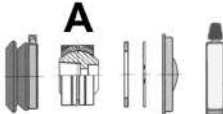

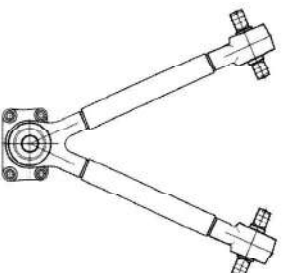

BARRE DI REAZIONE - TORQUE RODS

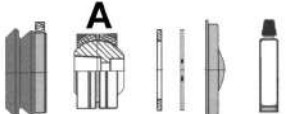
RIF. OCAP OCAP REF.	RIF. ORIG O.E. NUMBER	NOTE REMARKS	MODELLO / DESCRIZIONE MODEL / DESCRIPTION
0807691 	1629668 1629668 3986443 20477805	L=327	FH 12-FH 16-FL 4 - FM 7-FM 9-FM 10-FM 12 - NH 12
0807918 	20443061 20443061 20444418	L=435	FH 12- FM 9
0807770 A  A	6777705 6777705 3951306 6797979	L=510	FL 608-FL 611-FL 612
0907770 A 	3090015 3090015	L=60 D=40 d=20	
0808738 A  A	21051052 21051052	L=510	
0909994 A 	20702095 20702095	l=130	
0809366 A  A	1071674 1071674	L=570 T=36	FL6
0907917 A 	81432506009 81432506009		FL6
0807690 A  A	1626958 1626958 1626957	L=571 d=21	FH 12-FH 16 - FL 6-FM 7-FM 9-FM 10-FM 12 - NH 12 - FH 400 - 440 - 480 - 520
0907359 A 	274019 274019 273373 691709 4941233 6889509	l=130 p=30 D=70 d=21	
0809367 A  A	8074268 8074268	L=575 T=46	





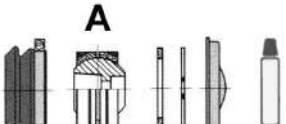

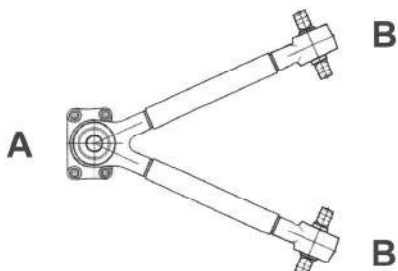

BARRE DI REAZIONE - TORQUE RODS

RIF. OCAP OCAP REF.	RIF. ORIG O.E. NUMBER	NOTE REMARKS	MODELLO / DESCRIZIONE MODEL / DESCRIPTION
0907405 A 	81432206202 81432206202	l=100 D=67 d=17	L 2000 - M 2000 L
0809369 A  A	1608151 1608151	L=621 T=48	
0907405 A 	81432206202 81432206202	l=100 D=67 d=17	L 2000 - M 2000 L
0809917 A  A	20374444	L=625	FH-FH12-FH16-FM-FM7-FM9-FM10-FM12 - FL6-NH12-B7-B7R
0907528 A 	271187 271187	l=115 p=24 D=62 d=17	
0807221 A  B	1080690 1080690 1576952 1606200 1509222	L=635 d=23	F 7-F 10-F 12-F 16 - FL 7-FL 10-FL 12 - N 10-N 12-N 10 BR-N 12BR - NL 10-NL 12
0907683 A 	276191 276191	D=80 IK=46	
0907686 B 	276192 276192	l=152 p=24 D=80 d=23	
0807544 A  B	1606552 1606552	L=641 d=21	F7-F10 (260-320) - F 12 (320-330-370)- F 16 - FL 7 (230-260-290)- FL 10 (320-360) - FL12 (380-420) - N 10







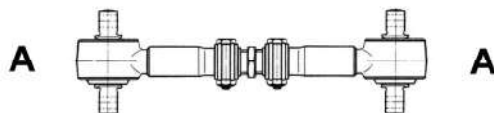

BARRE DI REAZIONE - TORQUE RODS

RIF. OCAP OCAP REF.	RIF. ORIG O.E. NUMBER	NOTE REMARKS	MODELLO / DESCRIZIONE MODEL / DESCRIPTION
0907545 	274069 274069	D=65 IK=42	
0907304 	274068 274068	l=152 p=24 D=70 d=21	
0809908 	1590068 1590068	L=644 T=46 l=115 d=17	F 10 - F 12 - F16 - FL 10 - FL 12 - FL 7 - N 10
0907406 	3133173 3133173	D=65	
0907528 	271187 271187	l=115 p=24 D=62 d=17	
0809909 	20502944 20502944 1094466 20382314	L=649 T=48 l=115 d=17/20	FL 12 - FL 6 - FL
0907487 	271188 271188	IK=38 D=65	
0909909 	3090452 3090452 3092452	l=115 p=24 D=75 d=17/20	









BARRE DI REAZIONE - TORQUE RODS

RIF. OCAP OCAP REF.	RIF. ORIG O.E. NUMBER	NOTE REMARKS	MODELLO / DESCRIZIONE MODEL / DESCRIPTION
0807529 	1576953 1576953	L=650 d=21	F 7-F 86 GB - FL 7-FL 10-FL 12-N 10
0907533 	273706 273706	L=61 IK=46 D=80	
0907529 	274056 274056 276192	l=152 p=35 D=80 d=23	
0809379 	20556492 20556492	L=660 T=48	FH12-FM12-FM7
0909379 	1075255 1075255	p=96 D=138	FH12-FM12-FM7
0909380 	1628107 1628107		FH12-FM12-FM7
0809371 	1620497 1620497	L=660 T=60	F10-F12-F16-FL10-FL12-FL7-NL10-NL12
0909994 	20702095 20702095	l=130	F10-F12-F16-FL10-FL12-FL7-NL10-NL12
0807687 	8158207 8158207 1581527 581528 1607079 8154018 8158206 8154017	L=660 d=21	F 7-F10 (260-320) - F 12 (320-330-370) - FL 7 (230-260-290) - FL 10 (320-360) - FL 12 (380-420) - N 10-N 12





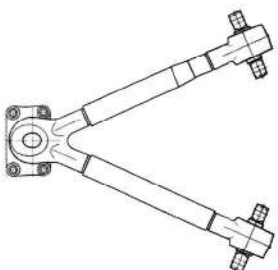

BARRE DI REAZIONE - TORQUE RODS

RIF. OCAP OCAP REF.	RIF. ORIG O.E. NUMBER	NOTE REMARKS	MODELLO / DESCRIZIONE MODEL / DESCRIPTION
0907359 A 	274019 274019 273373 691709 4941233 6889509	l=130 p=30 D=70 d=21	
0809381 A  B B	20491771 20491771	L=662 T=48	FH-FH12-FH16-FM-FM12-FM9-FH II-FMX-FMX II
0907913 A 	7420741710 7420741710	D=72	
0909909 B 	3090452 3090452 3092452	l=115 p=24 D=75 d=17/20	FH-FH12-FH16-FM-FM12-FM9-FH II-FMX-FMX II
0807913 A  B B	7420741703 7420741703	L=662	
0907913 A 	7420741710 7420741710	D=72	
0907919 B 	7420547286 7420547286	D=75	
0809382 A  B B	20556488 20556488	L=666 T=48	FH12-FH16-FM7-FM10-FM12

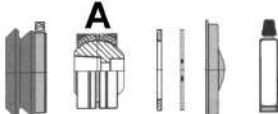
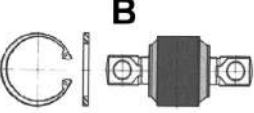

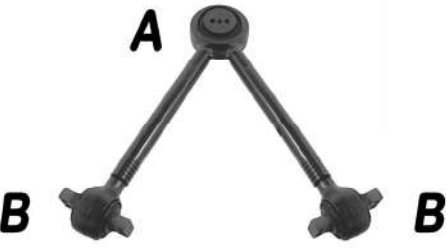

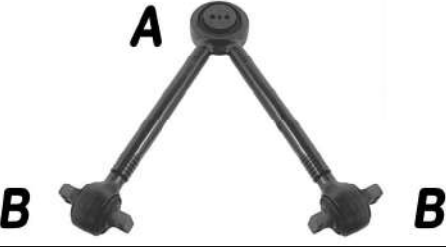

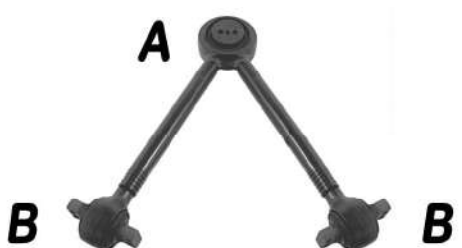

BARRE DI REAZIONE - TORQUE RODS

RIF. OCAP OCAP REF.	RIF. ORIG O.E. NUMBER	NOTE REMARKS	MODELLO / DESCRIZIONE MODEL / DESCRIPTION
0909379 A 	1075255 1075255	p=96 D=138	FH12-FH16-FM7-FM10-FM12
0909380 B 	1628107 1628107		FH12-FH16-FM7-FM10-FM12
0809375 A  A	1589817 1589817	L=666 T=48	
0907222 A 	1598588 1598588	l=125 p=20 D=91 d=14	
0807222 A  B	1082104 1082104 1605035	L=666 T=48	F10-F12-F16-FH12-FH16 - FL10-FL12-FL7-FM10-FM12
0907222 A 	1598588 1598588	l=125 p=20 D=91 d=14	
0907224 B 	1135080 1135080	D=91 d=52	
0809377 A  A	1606551 1606551	L=670 T=48	
0907296 A 	274070 274070	l=130 p=24 D=62 d=21	F 12 - F 16 - FL 10 - FL 12 - N 10
0807762 A  B	1076639 1076639 20392649 20829503 8154016 1606551 1626896 1629734 21295227	L=671 d=21	F12 - FH12 - FH16 - FL7 - FL10 - FL12 - FM7 - FM9 - FM12 - NH12 - FH400 - 440 - 480 - 520

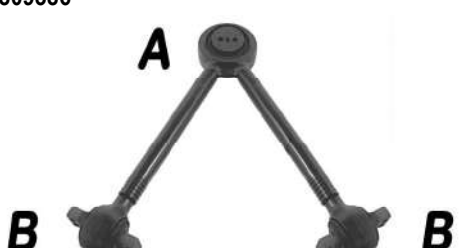

BARRE DI REAZIONE - TORQUE RODS

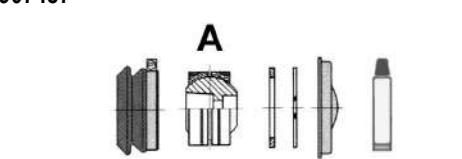
RIF. OCAP OCAP REF.	RIF. ORIG O.E. NUMBER	NOTE REMARKS	MODELLO / DESCRIZIONE MODEL / DESCRIPTION
0907762 	3090712 3090712	D=80	
0907763 	3093631 3093631	l=130 D=70 d=21	
0807914 	20589061 20589061		FH12 - FH16 - FM
0809383 	20556588	L=673 T=48	F10-F12-FL10-FL12
0909379 	1075255 1075255	p=96 D=138	F10-F12-FL10-FL12
0907222 	1598588 1598588	l=125 p=20 D=91 d=14	F10-F12-FL10-FL12
0809384 	20556493 20556493	L=676 T=48	FH12-FL6
0909379 	1075255 1075255	p=96 D=138	FH12-FL6
0909380 	1628107 1628107		FH12-FL6



BARRE DI REAZIONE - TORQUE RODS

RIF. OCAP OCAP REF.	RIF. ORIG O.E. NUMBER	NOTE REMARKS	MODELLO / DESCRIZIONE MODEL / DESCRIPTION
0809385 	20556491 20556491	L=677 T=48	FH12-FH16-FM7-FM10-FM12
0909379 	1075255 1075255	p=96 D=138	FH12-FH16-FM7-FM10-FM12
0909380 	1628107 1628107		FH12-FH16-FM7-FM10-FM12
0809386 	20556490 20556490	L=677 T=48	FH12-FH16-FM7-FM10-FM12-NH12
0909379 	1075255 1075255	p=96 D=138	FH12-FH16-FM7-FM10-FM12-NH12
0909380 	1628107 1628107		FH12-FH16-FM7-FM10-FM12-NH12
0809907 	3172829 3172829 8073569	L=677 T=48	FH 12-FH 16-FH-FL 12-FM 7-FM 9-FM 10-FM 12-NH 12
0907487 	271188 271188	IK=38 D=65	
0907529 	274056 274056 276192	l=152 p=35 D=80 d=23	

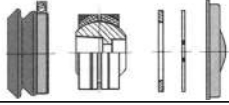

BARRE DI REAZIONE - TORQUE RODS

RIF. OCAP OCAP REF.	RIF. ORIG O.E. NUMBER	NOTE REMARKS	MODELLO / DESCRIZIONE MODEL / DESCRIPTION
0809378 	20410053 20410053	L=799 T=48	
0907528 	271187 271187	l=115 p=24 D=62 d=17	











KIT DI SOSPENSIONE - *SUSPENSION KITS*

RIF. OCAP OCAP REF.	RIF. ORIG O.E. NUMBER	NOTE REMARKS	MODELLO / DESCRIZIONE MODEL / DESCRIPTION
0907545 	274069 274069	D=65 IK=42	LP LP LP LPS MK NG SK - F 7 - F10 - F12 - FL 7 - FL 10 - FL12
0907770 	3090015 3090015	L=60 D=40 d=20	FL 608 - 611 - 612 - 614 - 615 - 618



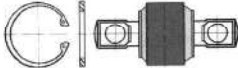



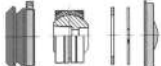

BARRE DI REAZIONE - TORQUE RODS

RIF. OCAP OCAP REF.	RIF. ORIG O.E. NUMBER	NOTE REMARKS	MODELLO / DESCRIZIONE MODEL / DESCRIPTION
0809443 	20448089 20448089 7420448089	L=564 I=111/115 d=17/19	FL - FL III
0809445 	21196798 21196798	L=625 I=115 d=17	FH 16 FMX II

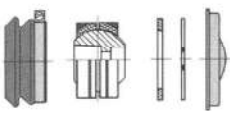
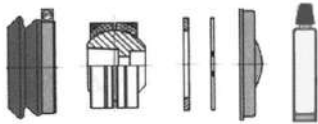
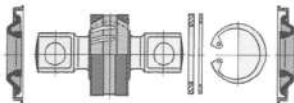

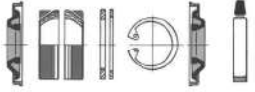



KIT DI SOSPENSIONE - SUSPENSION KITS

RIF. OCAP OCAP REF.	RIF. ORIG O.E. NUMBER	NOTE REMARKS	MODELLO / DESCRIZIONE MODEL / DESCRIPTION
0909909 	3090452 3090452 3092452	l=115 p=24 D=75 d=17/20	FH12-FH16-FL 12-FL 6-FL-FM 10-FM12-FM9-FM
0908778 	70371217 70371217	l=115 p=24 D=75 d=19	SERIE B7-B9
0907222 	1598588 1598588	l=125 p=20 D=91 d=14	F10-F12-F16-FH12-FH16-FL10-FL12-FL7-FM10-FM12
0907224 	1135080 1135080	D=91 d=52	F10-F12-F16-FH12-FH16-FL10-FL12-FL7-FM10-FM12
0907359 	274019 274019 273373 691709 4941233 6889509	l=130 p=30 D=70 d=21	F 10 - F 12 - F 16 - FH 12 - FH 16 - FL 7 - FL 10 - FL12
0907304 	274068 274068	l=152 p=24 D=70 d=21	F 7 - F 12 - F 16 - FL 7 - FL 10 - FL 12
0907763 	3093631 3093631	l=130 D=70 d=21	F12 - FH12 - FH16 - FL7 - FL10 - FL12 - FM7 - FM9 - FM12 - NH12 - FH400 - 440 - 480 - 520
0907296 	274070 274070	l=130 p=24 D=62 d=21	F 12 - F 16 - FL 10 - FL 12 - N 10
0907529 	274056 274056 276192	l=152 p=35 D=80 d=23	F 10 - F 12-FL 7 - FL 10 - FL12
0907405 	275988 275988	l=100 D=67 d=17	F 12 - FH 12 - FH 16 - FL10 - FM 12 - NH 12
0907683 	276191 276191	D=80 IK=46	F 7-F 10-F 12-F 16 - FL 7-FL 10-FL 12 - N 10-N 12-N 10 BR-N 12BR - NL 10-NL 12











KIT DI SOSPENSIONE - SUSPENSION KITS

RIF. OCAP OCAP REF.	RIF. ORIG O.E. NUMBER	NOTE REMARKS	MODELLO / DESCRIZIONE MODEL / DESCRIPTION
0907686 	276192 276192	l=152 p=24 D=80 d=23	F 7-F 10-F 12-F 16 - FL 7-FL 10-FL 12 - N 10-N 12-N 10 BR-N 12BR - NL 10-NL 12
0907297 	3093469 3093469	IK=38 D=65	FH16
0907487 	271188 271188	IK=38 D=65	FH12 - FH16 - FL7 - FL10 - FL12 - FM7 - FM12
0907257 	271188 271188	IK=38 T=50 D=65	FH12 - FH16 - FM7 - FM12 - FL7 - 10 - 12 - NH12
0907534 	273375 273375	l=152 p=35 D=80 d=23	FL 7 - FL 10 - FL 12
0907762 	3090712 3090712	D=80	F12 - FH12 - FH16 - FL7 - FL10 - FL12 - FM7 - FM9 - FM12 - NH12 - FH400 - 440 - 480 - 520
0907722 	-	D=80	FL7 - 10 - 12 - NL10 - 12
0907533 	273706 273706	L=61 IK=46 D=80	F 7 - F 12 - FL 7 - FL 10 - FL 12
0907528 	271187 271187	l=115 p=24 D=62 d=17	F 10 - F 12 - F 16 - FL 7 - FL 10 - FL 12 - FM 7 - FM 12 - FH 12 - FH16 - N10 - NH 12
0907913 	20741710 20741710 3093544		FE - FH12 - FH 400 > 520 - FL6 - FM 12 - FM 7 - FM9 - FM



KIT DI SOSPENSIONE - SUSPENSION KITS

RIF. OCAP OCAP REF.	RIF. ORIG O.E. NUMBER	NOTE REMARKS	MODELLO / DESCRIZIONE MODEL / DESCRIPTION
0907919 	20547286 20547286	D=75	FE - FH12 - FH 400 > 520 - FL6 - FM 12 - FM 7 - FM9 - FM
0907406 	3133173 3133173	D=65	F10 - F12 - F16 - FL10 - FL12
0907917 	3090015 3090015		FL6
0909994 	20702095 20702095		
0909379 	1075255 1075255	p=96 D=138	F10-F12-FH12-FH16-FL10-FL12-FM12-FM7
0909380 	1628107 1628107		F10-F12-FH12-FH16-FL10-FL12-FL6-FM10-FM12-FM7-NH12
0909389 	20840820 20840820	D=90	FH-FH12-FM-FM12-FM9-NH12







STABILIZZATORI - STABILIZERS

RIF. OCAP OCAP REF.	RIF. ORIG O.E. NUMBER	NOTE REMARKS	MODELLO / DESCRIZIONE MODEL / DESCRIPTION
0109903 	948372 948372	L=40 M=8x1 RHT	F 12 - F 16 - FH 12 - FH 16 - FL 6 - FL 7 - FL 10 - FH 400-440-480
0508786 	20477807 20477807	L=340 T=30	FH12-FH16-FM10-FM12-FM7-FM9-FMX II-FH16 II-FH II
0507123 	-	Lt=325	
0508787 	20443063 20443063	L=350 T=36	
0508788 	3173914 3173914	L=380 T=36	FH12-FL6-FM12-FM7
0507221 	20443062 20443062 20443066 20994419 21248088	L=380 T=36	FH 12 - FH 16
0509905 	3987354 3173613 3987354	L=435 T=36	FH 12 - FM 12 - FM 7
0509915 	21287061 21286847 21119064 21287061	L=435 T=36	FH 12 - FH 16 - FH 400-420-440-460-500-520-540 - FM 9 - FM
0507918 	20443061 20443061 20444418 20443065	L=435 T=36	FH 12 - 16 FM 9 - 12 FMX
0509449 	21119067 21119067 21119056 21287062 21119053	L=390 T=36	FH 12 - 16 FMX - FMX II
0509450 	22318841 22318841 21197609	L=373 T=38	FH 16 FMX II

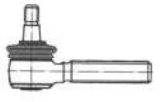

STABILIZZATORI - STABILIZERS

RIF. OCAP OCAP REF.	RIF. ORIG O.E. NUMBER	NOTE REMARKS	MODELLO / DESCRIZIONE MODEL / DESCRIPTION
0509451 	21176251 21176251 21146255 21176253 21176255 21182239 21146253 21182238 21287063	L=350 T=36	FH 12 - 16 FM 12 FMX - FMX II
0509452 	22318844 22318844 21209705	L=443 T=38	FH 16 FMX - FMX II
0509453 	3987356 3987356	L=350 T=36	FM 12





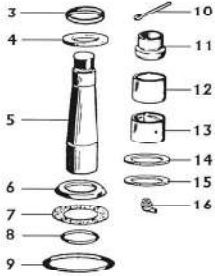
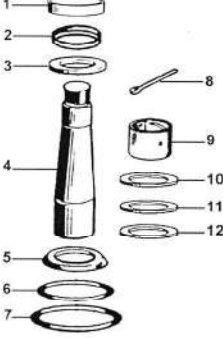



TESTE COMANDO CAMBIO - GEAR BOX CONTROL BALL JOINTS

RIF. OCAP OCAP REF.	RIF. ORIG O.E. NUMBER	NOTE REMARKS	MODELLO / DESCRIZIONE MODEL / DESCRIPTION
0287229 	1696685 1696685	L=55 M=12x1,75 RH	F 7-F 10-F 12-F 16 - FH 12-FH 16 - FL 608-614-615-616-617-619 - FS 7
0297229 	1696684 1696684	L=55 M=12x1,75 LH	F 7-F 10-F 12-F 16 - FH 12-FH 16 - FL 608-614-615-616-617-619 - FS 7
0187682 	382613 382613	L=55 M=12 x1,50 RH	F 10-F 12-FL 7-FL 10-FL 12 - SR 62-SR 70-R 70
0187228 	6853913 1672152 6853913 6027074 1132493	L=85 M=14 x 1,5 RH	F 4-F 6 - F 10-F 12-F 16 - FL 408-FL 6
0187241 	382745 1527234 1668638 382745	L=90 M=28x1,5 RH	F 7-F 10-F12-F 16 - FL 6-FL 7-FL 10-FL 12 - N 7-N 10-N 12
0187456 	1668179 1668179 1669010	L=97 M=16x1,5 RHT	FH12 - FH16 - FM7 - FM10 - FM12 - NH12
0189965 	3124625 3124625	L=115 M=14 x 1,5 RHT	FL6







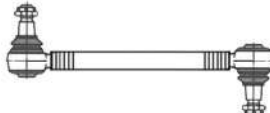

KIT PERNO FUSO - KING PIN SET

RIF. OCAP OCAP REF.	RIF. ORIG O.E. NUMBER	NOTE REMARKS	MODELLO / DESCRIZIONE MODEL / DESCRIPTION
0927456 	3090267 3090267 271141 270911 276015 276024 276030 276032	L=237 D=48	ASSALE/AXLE: 253270-253283-253295 - F7 - F10 - F12 - F16 - N7 - N10 - N12 - FL
0927458 	3090266 3090266 271142 270912 276023 276031	L=251 D=50/38	ASSALE/AXLE: 253290 - F7 - F S 7 - F10 - F12 - F16 - FH 12 - FH 16 - FL7 - FL10 - FL12 - FM7 - FM12 - N7 - N10 - NL10 - NL12
0927221 	20751021 20751021		8500-9700-B12-FH12-FH16-FH400-540-FH II-FL-FL6 - FM12- FM9-FM-FMX-FMX II

COMPONENTI - COMPONENTS

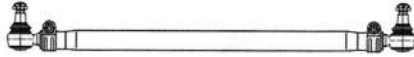
RIF. OCAP OCAP REF.	RIF. ORIG O.E. NUMBER	NOTE REMARKS	MODELLO / DESCRIZIONE MODEL / DESCRIPTION
1216351 	1624611 3028448	D=90	FH12-FH16
1216352 	1075180 1075180	d=44	FH12-FH16-FM7-FM9-FM12-FM16-NH12
1216353 	1075179 1075179	d=35	FH12-FH16-FM7-FM9-FM12-FM16-NH12
1216349 	3028448 3028448	D=90	FL6
1216350 	9519245 3028448	D=90	FH12-FH16-FM7
1216354 	1624605 1624605	D=45 d=17	FH12-FH16-FH 16 II-FL12-FL10-FL7-FM7-FM12-FM10
1216355 	1134955 1134955	D=57,5 d=28	FH12-FH16-FH 16 II-FL12-FL10-FL7-FM7-FM12-FM10
1249734 	20443059 20443059		FH12-FH16-FH16 II-FH-FH II-FM12-FM9-FM-FMX-FMX II
1249735 	1629553 1629553	L=150	FH12-FH16-FH16 II-FH-FH II-FM12-FM9-FM-FMX-FMX II



TIRANTI LONGITUDINALI - DRAG LINKS

RIF. OCAP OCAP REF.	RIF. ORIG O.E. NUMBER	NOTE REMARKS	MODELLO / DESCRIZIONE MODEL / DESCRIPTION
<p>0507128</p>  <p>0187125 M=38x1,5 RHT</p> <p>0197125 M=38x1,5 LHT</p>	<p>004908 004908</p>	<p>Lt=450</p>	<p>INBUS 330</p>
<p>0507126</p> 	<p>002765 002765</p>	<p>Lt=590</p>	<p>MENARINI U 150 - SICCA 181C-181/1C</p>
<p>0507127</p> 	<p>004909 004909</p>	<p>Lt=600</p>	<p>INBUS-SICCA 166L B</p>
<p>0507924</p>  <p>0186598 M30x1,5 RHT</p>	<p>S009593 S009593 0087932 389870</p>	<p>L=716 T=50</p>	<p>-</p>
<p>0507129</p>  <p>0187125 M=38x1,5 RHT</p>	<p>002763 002763 004728</p>	<p>Lt=725</p>	<p>MENARINI U150 - SICCA 181C-181/1C</p>
<p>0507131</p>  <p>0186598 M=30x1,5 RHT</p> <p>0196598 M=30x1,5 LHT</p>	<p>065475 065475 065472 065475.0</p>	<p>Lt=805</p>	<p>MENARINI 201 L</p>
<p>0507134</p> 	<p>000221 000221</p>	<p>Lt=805</p>	<p>INBUS 280 FT</p>
<p>0507132</p>  <p>0187125 M=38x1,5 RHT</p>	<p>000218 000218</p>	<p>Lt=1170</p>	<p>INBUS - SICCA</p>
<p>0507130</p> 	<p>004729 004729</p>	<p>Lt=1260</p>	



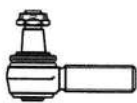
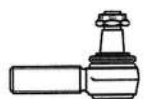

TIRANTI LONGITUDINALI - DRAG LINKS

RIF. OCAP OCAP REF.	RIF. ORIG O.E. NUMBER	NOTE REMARKS	MODELLO / DESCRIZIONE MODEL / DESCRIPTION
<p>0507133</p>  <p>0186598 M=30x1,5 RHT</p>	<p>043102 043102 043102.3</p>	<p>Li=1300</p>	<p>MENARINI 201 L</p>







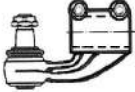
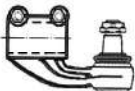

TESTE STERZO - TIE RODS END

RIF. OCAP OCAP REF.	RIF. ORIG O.E. NUMBER	NOTE REMARKS	MODELLO / DESCRIZIONE MODEL / DESCRIPTION
0186598 	004206 004206 189716	L=120 M=30x1,5 RHT	MENARINI
0196598 	004204 004204 189717	L=120 M=30x1,5 LHT	MENARINI
0187125 	000978 000978	L=120 M=38x1,5 RHT	INBUS SICCA
0197125 	000192 000192 000977	L=120 M=38x1,5 LHT	INBUS SICCA





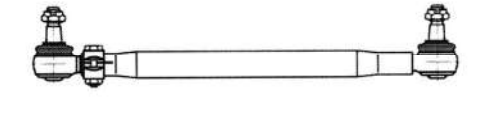

TESTE STERZO - TIE RODS END

RIF. OCAP OCAP REF.	RIF. ORIG O.E. NUMBER	NOTE REMARKS	MODELLO / DESCRIZIONE MODEL / DESCRIPTION
0186424 	0586753 0586753 1229944 0607999 0694298 0694360 0698609 586753 698609	L=115 M=30x1,5 RH	MB 230-SB 210 - SB 2300-SB 2305-SB 3000
0196424 	1319838 1319838 0311300 0607998 1315447 1338714 1407394	L=115 M=30x1,5 LH	MB 230-SB 210 - SB 2300-SB 2305-SB 3000
0186598 	1257890 1257890 0607981 0698450 0696226	L=120 M=30x1,5 RH	SB 2000-SB 2500
0196598 	1228115 1228115 0607053 1329134 0696225	L=120 M=30x1,5 LHT	SB 2000-SB 2500
0286427 	0606923 0606923 606923	L=130 M=46x1,5 RHT	MGB/MB 200 - TB 2100
0296427 	0606922 0606922 606922	L=130 M=46x1,5 LHT	MGB/MB 200 - TB 2100

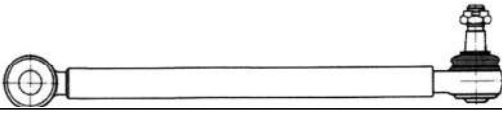
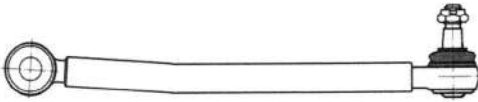



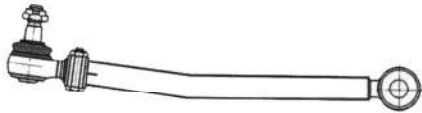

BARRE ACCOPPIAMENTO - TIE RODS

RIF. OCAP OCAP REF.	RIF. ORIG O.E. NUMBER	NOTE REMARKS	MODELLO / DESCRIZIONE MODEL / DESCRIPTION
0586419  0186598 M=30x1,5 RHT	4826513 4826513 4827082 4862449 4862451	L=780 T=48	TURBOCITY: 480-580-680
0596419  0186598 M=30x1,5 RHT	4838587 4838587 4822291	L=780 T=48	TURBOCITY: - 480-580-680
0506762  0186598 M=30x1,5 RHT	42044493 42044493	L=796 T=48	470.20 - 470.20 U-EFFEUNO - 570.20-571.20 - 670.20 - 671.24 I.EFFEUNO
0509918  0186424 M=30x1,5 RHT 0196424 M=30x1,5 LHT	5801891027 504126384 5801891027	L=803 T=38	IRISBUS: ARWAY-CROSSWAY-EVADYS-MAGELYS-RECRO
0508737  0186424 M=30x1,5 RHT	5010347549 5010347549	L=1675 T=50	AGORA - CRISTALIS - GX
0509370  0186598 M=30x1,5 RHT	99432053 99432053	L=1717 T=50	CITYCLASS
0506410  0186598 M=30x1,5 RHT	98420110 98420110 98420112	L=860 T=48	EUROCLASS: 29-35
0506412  0186598 M=30x1,5 RHT	98489741 98489741	L=1627 T=52	EURORIDER: .26-.29-.35-.38 393.35 MY WAY





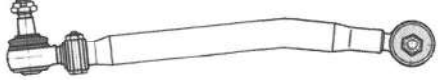





TIRANTI LONGITUDINALI - DRAG LINKS

RIF. OCAP OCAP REF.	RIF. ORIG O.E. NUMBER	NOTE REMARKS	MODELLO / DESCRIZIONE MODEL / DESCRIPTION
0507167 	4557357 4557357		306
0507170 	42019074 42019074	Lt=635	AP 160 - AP 160.12.26
0507169  0186599 M=38x1,5 RHT	4704239 4704239 4716557	Lt=800	370.12.26
0507367  0187364 M=30x1,5 RHT	500336085 500336085 500308895 99455009	L=883 T=52	
0506795 	2506671 2506671 6013743	Lt=930	230E113 - 260E13-260E113
0506931  0186598 M=30x1,5 RHT	41005463 41005463 8131582 8132397 41042919	L=953	CITYCLASS: - 591.27
0507850  0186598 M=30x1,5 RHT	98473328 98473328	L=966	EUROFIRE TECT: - 100E21
0507853  0186424 M=30x1,5 RHT	500363545 500363545	L=1114	TECTOR: - CC100E18/E21

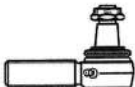
TIRANTI LONGITUDINALI - DRAG LINKS

RIF. OCAP OCAP REF.	RIF. ORIG O.E. NUMBER	NOTE REMARKS	MODELLO / DESCRIZIONE MODEL / DESCRIPTION
0507852  0186424 M=30x1,5 RHT	500362533 500362533	L=1190	TECTOR: - CC130E24
0506781 	4672795 4672795		409 VAR. 10-10/1
0506774 	4659860 4659860		343/L/ST
0507168 	4668771 4668771		308-343
0506760  0186599 M=38x1,5 RHT	4711108 4711108 4711109	L=845 T=48	370.24/25/25L/29/30/35 PASSO 6290 260R119
0506413  0186599 M=38x1,5 RHT	98491559 98491559 4702125 500311471 500311473	L=889 T=62	EURORIDER: .29-.29A-.35-.35A
0506811  0186599 M=38x1,5 RHT	4741957 4741957 4741956	L=1441 T=48	260R106 370S.24 370.24







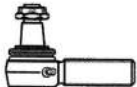
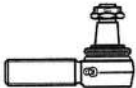

TESTE STERZO - TIE RODS END

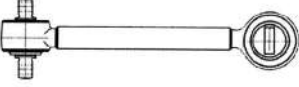
RIF. OCAP OCAP REF.	RIF. ORIG O.E. NUMBER	NOTE REMARKS	MODELLO / DESCRIZIONE MODEL / DESCRIPTION
0186424 	579342 579342	L=115 M=30x1,5 RHT	5061 DA - 5062 A - 5062 B - 5063 DR
0196424 	579343 579343	L=115 M=30x1,5 LHT	5061 DA - 5062 A - 5062 B - 5063 DR
0287552 	42534911 42534911	L=80 M=16x1,5 RH	40C13 - 50C13 - 50C15
0287238 	93192809 93192809	L=91 M=30x1,5 RH	CITYCLASS: - 491.24CNG - 591.27 - - Testa per servosterzo terzo asse - (Tie rod end for power steering axle)
0186604 	4028250 4028250		308/343 - 409 VAR. 10-10/I
0196604 	4028251 4028251		308/308 L - 309 A
0186599 	4688948 4688948	L=120 M=38x1,5 RH	370.20/.24/.25/.25L/.26/.30/.35
0186598 	2966252 2966252 42537936 42488269 42483386 4802443 2969808 42489594 8122752 42489573 42491638	L=120 M=30x1,5 RHT	TURBOCITY 480 - 580
0196598 	574274 574274	L=120 M=30x1,5 LHT	TURBOCITY 480 - 580
0186605 	4664297 4664297	L=130 M=38x1,5 RHT	306/343/L/ST
0187166 	4664340 4664340	L=130 M=42x1,5 RHT	





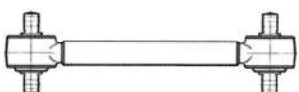

TESTE STERZO - TIE RODS END

RIF. OCAP OCAP REF.	RIF. ORIG O.E. NUMBER	NOTE REMARKS	MODELLO / DESCRIZIONE MODEL / DESCRIPTION
0197166 	4664341 4664341	L=130 M=42x1,5 LHT	
0186620 	4661613 4661613	L=135 M=38x1,5 RH	421 A/AL
0196620 	4661614 4661614	L=135 M=38x1,5 LH	

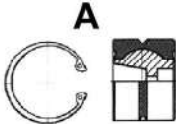

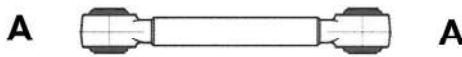
BARRE DI REAZIONE - TORQUE RODS

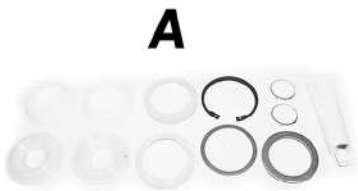
RIF. OCAP OCAP REF.	RIF. ORIG O.E. NUMBER	NOTE REMARKS	MODELLO / DESCRIZIONE MODEL / DESCRIPTION
0807339 A 	99432565 99432565	L=510 d=15	490.29E2 - 490.18.29E2 > C.H. 1996-01-03 - CITYCLASS: - 25 29 31 - 491.22-491.24CNG-491.27 - 591.22-591.27
0907339 A 	42535445 42535445	l=100 p=24 D=67 d=15	
0809925 A  A	5006305890 5006305890	L=545 T=46 l=130 d=19	IRISBUS: EURORIDER
0907259 A 	42488722 42488722 2969844	l=130 p=30 D=70 d=19	
0809924 A  A	5006305892 5006305892	L=550 T=46 l=130 d=19	IRISBUS: EURORIDER
0907259 A 	42488722 42488722 2969844	l=130 p=30 D=70 d=19	
0807213 A  A	98488010 98488010	L=583 d=19	CITYCLASS: - 491.22/.24/.27 - 591.22/.24/.27
0907259 A 	42488722 42488722 2969844	l=130 p=30 D=70 d=19	
0807227 A  B	4865483 4865483	L=703	BUS: EUROCLASS 29/35/36/43/HJD

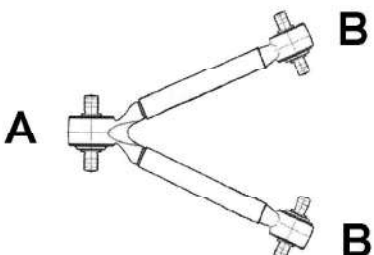

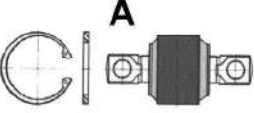

BARRE DI REAZIONE - TORQUE RODS

RIF. OCAP OCAP REF.	RIF. ORIG O.E. NUMBER	NOTE REMARKS	MODELLO / DESCRIZIONE MODEL / DESCRIPTION
0907260 	93194458 93194458	D=80	
0907258 	2980884 2980884 81432206132	l=130 p=30 D=65 d=19	
0807210 	4738069 4738069	L=730	370S/24/25L/30/35 - 370S/E27/E29/E35 - - Sospensioni anteriori - (Front suspension)
0907210 	-	D=80	
0907586 	093161371 093161371 0005861533	D=65	senza perno (without pin)
0809921 	5006305888 5006305888	L=760 T=46 l=130 d=19	IRISBUS: EURORIDER - IRIZAR: PB
0907259 	42488722 42488722 2969844	l=130 p=30 D=70 d=19	
0807341 	99484068 99484068 99439665	L=660 T=48 d2=19 d1=21	CITYCLASS: 25-29-31 490.18-491.22/27 591.22/27

BARRE DI REAZIONE - TORQUE RODS

RIF. OCAP OCAP REF.	RIF. ORIG O.E. NUMBER	NOTE REMARKS	MODELLO / DESCRIZIONE MODEL / DESCRIPTION
0907583  <p>A</p>	42530929 42530929	l=145 p=30 d=21	
0907327  <p>B</p>	93192361 93192361	l=130 p=24 D1=75 d=19	

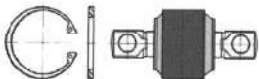
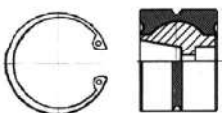



KIT DI SOSPENSIONE - SUSPENSION KITS

RIF. OCAP OCAP REF.	RIF. ORIG O.E. NUMBER	NOTE REMARKS	MODELLO / DESCRIZIONE MODEL / DESCRIPTION
0907339 	42535445 42535445	l=100 p=24 D=67 d=15	CITYCLASS
0907362 	5000333285 5001850588 5000333285 5001860300 5010393047 42536819	l=130 D=85 d=19	BUS URBANWAY - IRISBUS: ACCESS-AXER-ARWAY-CITELIS
0907327 	93192361 93192361	l=130 p=24 D=62 d=19	EURORIDER - CITYCLASS
0907583 	42530929 42530929	l=145 p=30 d=21	CITYCLASS
0907260 	93194458 93194458	D=80	EURORIDER
0907259 	42488722 42488722 2969844	l=130 p=30 D=70 d=19	IRISBUS: - ACCESS - ARWAY - CITELIS - CROSSWAY - EVADYS - EURORIDER
0907331 	93194457 93194457 93192618 42535446 42488722	l=130 D=85 d=19	BUS: URBANWAY

SNODI SOSPENSIONI - SUSPENSION JOINTS

RIF. OCAP OCAP REF.	RIF. ORIG O.E. NUMBER	NOTE REMARKS	MODELLO / DESCRIZIONE MODEL / DESCRIPTION
0409919 	5010556210 5010556210 504201479 5801208436	L=198 M=36X1,5 RHT	IRISBUS: ARWAY-CROSSWAY-EVADYS-MAGELYS-RECRO



STABILIZZATORI - STABILIZERS

RIF. OCAP OCAP REF.	RIF. ORIG O.E. NUMBER	NOTE REMARKS	MODELLO / DESCRIZIONE MODEL / DESCRIPTION
0507888 	5010199642 5010199642	L=195	IRIS BUS
0589922 	5006306002 5801893542 5006306002	L=167 T=31	IRISBUS: DOMINO - IRIZAR: PB
0599922 	5006306003 5006306003 5801893544	L=167 T=31	IRISBUS: DOMINO - IRIZAR: PB
0858055 	5006306531 5006306531	L=1065 T=42	IRISBUS: EURORIDER - BARRA STABILIZZATRICE - STABILIZER BAR







TESTE COMANDO CAMBIO - GEAR CONTROL BALL JOINTS

RIF. OCAP OCAP REF.	RIF. ORIG O.E. NUMBER	NOTE REMARKS	MODELLO / DESCRIZIONE MODEL / DESCRIPTION
<p>0187228</p> 	<p>42487482 86027074 7981909 42487482</p>	<p>L=85 M=14 x 1,5 RH</p>	<p>AP 160 > 370 SE.27 - 75-9A - 80-13.ABP/A2/A3 - 80-16A4 90-13A - 110-13A/16A - 130-13A/16A</p>



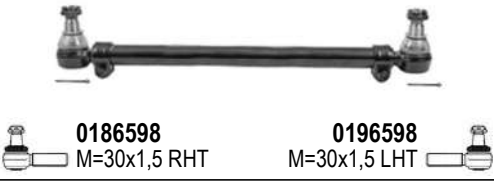



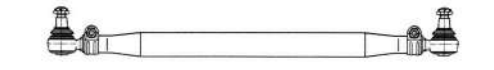

COMPONENTI - COMPONENTS

RIF. OCAP OCAP REF.	RIF. ORIG O.E. NUMBER	NOTE REMARKS	MODELLO / DESCRIZIONE MODEL / DESCRIPTION
1216307 	5006305917 5006305917		IRISBUS: EURORIDER - BOCCOLA BARRA STABILIZZATRICE - STABILIZER BAR BUSH
1216308 	500345518 500345518		IRISBUS: EURORIDER - BOCCOLA BARRA STABILIZZATRICE - STABILIZER BAR BUSH

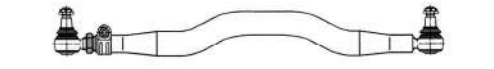
BARRE ACCOPPIAMENTO - TIE RODS

RIF. OCAP OCAP REF.	RIF. ORIG O.E. NUMBER	NOTE REMARKS	MODELLO / DESCRIZIONE MODEL / DESCRIPTION
0507957 	81467116877 81467116771 81467116780 81467116877 81467116878 81467116879 81467116972	L=413 T=30	LION'S COACH-LION'S STAR - UL
0507954 	81467116898 81467116886 81467116897 81467116898 81467116899	L=429 T=36	HOCL 24.440 - 24.460 - 24.480
0507950  0186598 M=30x1,5 RHT 0196598 M=30x1,5 LHT	81467116762 81467106080 81467106136 81467106172 81467106295 81467106337 81467106345 81467106421 81467106451 81467106876 81467116762	L=501 T=40	LION S COACH - STAR - UL
0507743  0186598 M=30x1,5 RHT 0196598 M=30x1,5 LHT	81467116874 81467116770 81467116772 81467116874 81467116875 81467116876	L=660 T=36	HOCL - LION S COACH-STAR - UL - RH
0507407 	81467116765 81467116765 81467106453 81467106457 81467106458 81467106875 81467106881 81467116766 81467116767		LIONS S STAR - S COACH - R - 362 - 332 - 263
0507806 	81467106877 81467106877 81467106875 81467106444 81467106419 81467106081 81467106173 81467106137 81467106294 81467106879 81467116759	L=729	LION'S COACH FRH: - FRH 362-R R/FR/FRH 292 - SG SG 220- SG 240 HU-SG 242 H - SG SG 240H-SG 242-SG 242 H - SG SG 240 H-SG 292 H-SG SG 242 - SG 292-SG SG 312-SG 322 - SL IISL202-SL SL 200- SR SR 240 /280 - SR 280 H-SR SR 321 H-SU SU 240/242/272/322 - UL UL313/353 - LION'S STAR
0509967 	81467106420 81467106420	L=786 T=40	









BARRE ACCOPPIAMENTO - TIE RODS

RIF. OCAP OCAP REF.	RIF. ORIG O.E. NUMBER	NOTE REMARKS	MODELLO / DESCRIZIONE MODEL / DESCRIPTION
<p>0507848</p>  <p>0186598 M=30x1,5 RHT 0196598 M=30x1,5 LHT</p>	<p>81466106579 81466106579 81466106580 81466106583 81466106624 81466106640 81467116720</p>	L=1530	SG SG: 220-240-242
<p>0507534</p>  <p>0186424 M=30x1,5 RHT 0196424 M=30x1,5 LHT</p>	<p>81467106316 81467106316 81467106314 81467106315</p>	L=1545 T=38	HOCL
<p>0507817</p>  <p>0186598 M=30x1,5 RHT</p>	<p>81467106912 81467106912</p>	L=1588	LION'S COACH - LION'S STAR
<p>0507840</p>  <p>0186613 M=28x1,5 RHT 0196613 M=28x1,5 LHT</p>	<p>81467106852 81467106852 81467106851 81467106395 81467116719</p>	L=1620	L 2000: - 8.150-8.220 - 10.150-10.220
<p>0507811</p>  <p>0186598 M=30x1,5 RHT</p>	<p>81467116722 81467116722 81467106902</p>	L=1676 T=50	UL 242-272-292-312-322
<p>0507824</p>  <p>0187843 M=30x1,5 RHT</p>	<p>81467106974 81467106974 81467116712 81467106862 81467106863 81467106864 81467106909 81467106910 81467116845</p>	L=1689 T=50	EL-NG-NL-NM
<p>0507894</p>  <p>0187894 M=30x1,5 RHT</p>	<p>81467116715 81467116715</p>	L=1702	NG - NL - NU
<p>0507742</p>  <p>0186424 M=30x1,5 RHT</p>	<p>81467106908 81467106908 81467106818 81467106459 81467106806 81467106819</p>	L=1725 T=50	NG - NL

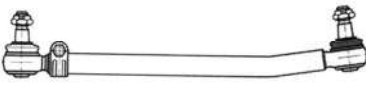















BARRE ACCOPPIAMENTO - TIE RODS

RIF. OCAP OCAP REF.	RIF. ORIG O.E. NUMBER	NOTE REMARKS	MODELLO / DESCRIZIONE MODEL / DESCRIPTION
<p>0509980</p>  <p>0186598 M=30x1,5 RHT</p>	<p>81467116727</p>	<p>L=1729 T=50</p>	



TIRANTI LONGITUDINALI - DRAG LINKS

RIF. OCAP OCAP REF.	RIF. ORIG O.E. NUMBER	NOTE REMARKS	MODELLO / DESCRIZIONE MODEL / DESCRIPTION
<p>0507791</p> 	<p>81466116045 81466116045 81466106795 81466116047 81466116049 81466116115 81466116126</p>	<p>L=628 T=40</p>	<p>LION S CITY - NG-NL-NU</p>
<p>0509966</p> 	<p>81466116131 81466116131</p>	<p>L=745 T=40</p>	
<p>0507818</p>  <p>0186613 M=28x1,5 RHT</p>	<p>81466106305 81466106305</p>	<p>L=785</p>	<p>G 8 - G 9 - G 90</p>
<p>0509972</p>  <p>0186598 M=30x1,5 RHT</p>	<p>81466106313 81466106313</p>	<p>L=895</p>	<p>HOCL 16.240/280/290/360/370/372</p>
<p>0509920</p>  <p>0186598 M=30x1,5 RHT</p>	<p>81466116067 81466106708 81466116067</p>	<p>L=905 T=52</p>	<p>HOCL-L 2000-NL-SU</p>
<p>0509974</p>  <p>0186598 M=30x1,5 RHT</p>	<p>81466116149 81466116149</p>	<p>L=925</p>	<p>LION'S CITY - 18.370/420/460 - 18.260</p>
<p>0507955</p>  <p>0186598 M=30x1,5 RHT 0196598 M30x1,5 LHT</p>	<p>81466116201 81466106374 81466116019 82466106080 82466106189 82466106190</p>	<p>L=1050 T=42</p>	<p>NG-NL-NM</p>
<p>0507809</p>  <p>0186598 M=30x1,5 RHT</p>	<p>81466116081 81466106711 81466106785 81466116043 81466116081</p>	<p>L=1059 T=52</p>	<p>HOCL - NL</p>





TIRANTI LONGITUDINALI - DRAG LINKS

RIF. OCAP OCAP REF.	RIF. ORIG O.E. NUMBER	NOTE REMARKS	MODELLO / DESCRIZIONE MODEL / DESCRIPTION
0507549  0287907  M=52x1,5 RHT	81466116017 81466116017 81466106706	L=1066 T=60	HOCL 18.220
0507410  0187410  M=30x1,5 RHT	83466106001 36466106012 36466106040 81466116217 83466106001 83466106501	L=1103 T=50	HOCL - SU - LION S CITY
0507204  0187410  M=30x1,5 RHT	81466106648 81466106648 81466116150	L=1145 T=50	HOCL
0507685  0287907  M=52x1,5 RHT	81466106684 81466106375 81466106684 81466116016	L=1260 T=60	EL - NG - NL
0507212  0186598  M=30x1,5 RHT	81466106606 81466106606	L=1270 T=48	HOCL
0507952  0186758  M=30x1,5 RHT	81466116085 36466106007 36466106033 81466106794 81466116044 81466116085 81466116108 81466116114 81466116120	L=1358 T=52	NG - NL - NU
0509977  0186598  M=30x1,5 RHT	81466106654 81466106654	L=1375 T=40	
0509979  0186598  M=30x1,5 RHT	81466106694 81466106694	L=1705 T=40	







TIRANTI LONGITUDINALI - DRAG LINKS

RIF. OCAP OCAP REF.	RIF. ORIG O.E. NUMBER	NOTE REMARKS	MODELLO / DESCRIZIONE MODEL / DESCRIPTION
<p>0509983</p>  <p>0186598 M=30x1,5 RHT </p> <p>0196598 M=30x1,5 LHT </p>	<p>81466106292 81466106292</p>	<p>L=1922 T=50</p>	











TESTE STERZO - TIE RODS END

RIF. OCAP OCAP REF.	RIF. ORIG O.E. NUMBER	NOTE REMARKS	MODELLO / DESCRIZIONE MODEL / DESCRIPTION
0186613 	81953016060 81953016060 81953016135 81953016140 81953016249	L=105 M=28x1,5 RHT	L 2000: 8.150-8.220 - 10.150-10.220
0196613 	81953010079 81953010079 81953016139 81953016222	L=105 M=28x1,5 LHT	L 2000: 8.150-8.220 - 10.150-10.220
0186424 	81953016239 81953016239 81953016250 81953010064 81953010014 81953016162 81953016067 90804153111	L=115 M=30x1,5 RHT	EM/NM: - 222-223 - NL - NL 202
0196424 	81953010074 81953010074 81953010013 81953016163 81953016068 90804153107 90804153113	L=115 M=30x1,5 LHT	EM/NM 222-223
0186598 	81953016278 81953016234 81953016278 81953016242 81953016108 81953016112 81953010016 81953016048 81953016049 81953016053 81953016126 81953016090 81953016143 81953016149 81953016154 81953016156 81953016194 81953016274 81953016178 81953016224 81953010084	L=120 M=30x1,5 RHT	EL - EM - FRH - NG - NL - NM - SG - SL - SR - LION'S STAR - LION'S COACH











TESTE STERZO - TIE RODS END

RIF. OCAP OCAP REF.	RIF. ORIG O.E. NUMBER	NOTE REMARKS	MODELLO / DESCRIZIONE MODEL / DESCRIPTION
0196598 	81953016279 81953016237 81953016279 81953010015 81953010087 81953016030 81953016043 81953016050 81953016054 81953016087 81953016125 81953016091 81953016107 81953016120 81953016152 81953016155 81953016157 81953016168 81953016179 81953016275 81953016223	L=120 M=30x1,5 LHT	EL - EM - FRH - NG - NL - NM - SG - SL - SR - LION'S STAR - LION'S COACH
0186758 	81953010022 81953010022 0696226 0609643 0586714 0609634 0607073 1337367	L=135 M=30x1,5 RHT	EL - EM - LION'S STAR - FRH - RH - NG - NL - NM - SG - SL - SR - SU
0187843 	81953016270 81953016270	L=141 M=30x1,5 RHT	EL EL 202-222-262 - NG NG 262-63-272-312-313 - NM NM 152
0187894 	81953016271 81953016271 81953016325	L=145 M=30x1,5 RHT	NG - NL - NU
0187410 	81953016355 81953016355 81953010089 81953016345	L=155 M=30x1,5 RHT	HOCL - SU - LION S CITY
0287907 	81953016277 81953016233 81953016255 81953016277 0004606748	L=168 M=52x1,5 RHT	EL - NG - NL - HOCL 18.220









BARRE DI REAZIONE - TORQUE RODS

RIF. OCAP OCAP REF.	RIF. ORIG O.E. NUMBER	NOTE REMARKS	MODELLO / DESCRIZIONE MODEL / DESCRIPTION
0807816 A  B	81432206177 81432206177 81432206179 81432206224	L=330 T=36	LION S COACH - STAR
0909984 A 	81432206224 * 81432206224 *		
0907816 B 	81432206177 * 81432206177 *		
0807806 	81432206215 81432206164 81432206165 81432206166 81432206215 81432206227 81432206228	L=413 d=15 l=80	LION S CITY - NG-NL-NM-NU
0807819 A  A	81432206254 81432206248 81432206251 81432206254 81432206256	L=470 T=48 l=130 d=19	HOCL - LION S CITY-COACH-STAR
0907407 A 	85432206002 85432206002 500333284 0003302011		
0807808 A  A	81432206145 81432206145 81432206208 81432206209 81432206162 81432206160	L=531 T=48	LION S CITY - NG-NL-NM-NU
0907259 A 	81432206055 81432206055 81432206073 81432206107 81432206104	l=130 p=30 D=70 d=19	
0807821 A  A	81432206161 81432206161 81432206190	L=531 T=50 l=130 d=19	NG - NL - NU
0907259 A 	81432206055 81432206055 81432206073 81432206107 81432206104	l=130 p=30 D=70 d=19	





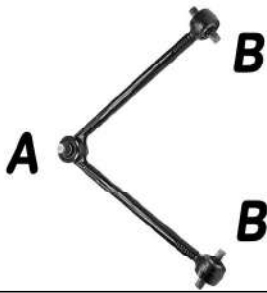

BARRE DI REAZIONE - TORQUE RODS

RIF. OCAP OCAP REF.	RIF. ORIG O.E. NUMBER	NOTE REMARKS	MODELLO / DESCRIZIONE MODEL / DESCRIPTION
0807823 A 	81432206183 81432206151 81432206183 81432206276	L=570 T=48 l=130 d=19	HOCL - LION S COACH-STAR - UL
0907259 A 	81432206055 81432206055 81432206073 81432206107 81432206104	l=130 p=30 D=70 d=19	
0807832 A  A	81432206279 81432206258 81432206264 81432206275 81432206278 81432206279	L=622 T=48 l=130 d=19	HOCL - LION S COACH-STAR
0907362 A 	81432706127 81432706127	l=130 D=85 d=19	
0807408 A 	81432206189 81432206396 81432206409 81432206144 81432206210 81432206189 81432206211	L=614 T=48 l=130 d=19	LION S CITY - NG - NL - NU
0907259 A 	81432206055 81432206055 81432206073 81432206107 81432206104	l=130 p=30 D=70 d=19	
0807409 A  B	81432206127 81432206112 81432206123 81432206125 81432206127 81432206220	L=630 T=50	LION S CITY - HOCL-NL
0907259 A 	81432206055 81432206055 81432206073 81432206107 81432206104	l=130 p=30 D=70 d=19	
0907409 B 	81432206204 81432206204	D=94	
0807410 A  B	81432206187 81432206187 81432206234 81432206240	L=633 T=50	LION S COACH - S STAR



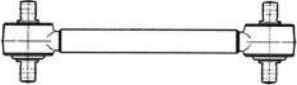







BARRE DI REAZIONE - TORQUE RODS

RIF. OCAP OCAP REF.	RIF. ORIG O.E. NUMBER	NOTE REMARKS	MODELLO / DESCRIZIONE MODEL / DESCRIPTION
0907259 A 	81432206055 81432206055 81432206073 81432206107 81432206104	l=130 p=30 D=70 d=19	
0907409 B 	81432206204 81432206204	D=94	
0807915 A  B	81432206134 81432206134	L=633 T=50	LION S COACH - S STAR
0907359 	81432206203 81432206203	l=130 p=30 D=70 d=21	
0907409 B 	81432206204 81432206204	D=94	
0807822 A  A	81432206185 81432206185 81432206100 81432206099 81432206103 81432206113 81432206114 81432206143 81432206173	L=750 T=48 l=130 d=19	EL - NG - NL
0907259 A 	81432206055 81432206055 81432206073 81432206107 81432206104	l=130 p=30 D=70 d=19	
0807844 A  B	81433156037 81433156037 81433156036	L=782 T=48	LION S - COACH - STAR - CENTROLINER
0907844 A 	81433150009 81433150009	l=145 p=35 D=95 d=19	



BARRE DI REAZIONE - TORQUE RODS

RIF. OCAP OCAP REF.	RIF. ORIG O.E. NUMBER	NOTE REMARKS	MODELLO / DESCRIZIONE MODEL / DESCRIPTION
0907845 B 	81432706133 81432706133 5001847026	l=130 p=30 D=85 d=21	
0807950 A  A	81432506011 81432506011	L=880	
0907950 	81432506017 81432506017		
0807812 A  A	81432206025 81432206025	L=455 d=19	SL 200-SU 240
0907259 A 	81432206055 81432206055 81432206073 81432206107 81432206104	l=130 p=30 D=70 d=19	
0807814 A  A	81432206042 81432206042	L=762 d=19	SR 240-SR 280-SR 280H-SR 321H
0907259 A 	81432206055 81432206055 81432206073 81432206107 81432206104	l=130 p=30 D=70 d=19	





KIT DI SOSPENSIONE - SUSPENSION KITS

RIF. OCAP OCAP REF.	RIF. ORIG O.E. NUMBER	NOTE REMARKS	MODELLO / DESCRIZIONE MODEL / DESCRIPTION
0907330 	81432706045 81432706045 81432706040	l=152 p=24 D=80 d=21	VARIO: O 810-O 812-O 814-O 815 - O 816
0907362 	81432706127 81432706127	l=130 D=85 d=19	EL - NG - NL
0907409 	81432206204 81432206204	D=94	BUS LION S CITY - HOCL-NL
0907259 	81432206055 81432206055 81432206073 81432206107 81432206104	l=130 p=30 D=70 d=19	LION'S COACH - LION'S STAR - EL - NG - NL - NU - SL - VARIO
0907528 	81432306051 81432306051	l=115 p=24 D=62 d=17	UL 242 - 272 - 292 - 312 - 322
0907407 	85432206002 85432206002 500333284 0003302011		HOCL - LION S CITY-COACH-STAR
0907844 	81433150009 81433150009	l=145 p=35 D=95 d=19	LION S - COACH - STAR
0907845 	81432706133 81432706133 5001847026	l=130 p=30 D=85 d=21	LION S - COACH - STAR - CENTROLINER
0909984 	81432206224 * 81432206224 *		
0907816 	81432206177 * 81432206177 *		
0907950 	81432506017 81432506017		

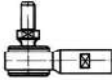

KIT DI SOSPENSIONE - *SUSPENSION KITS*

RIF. OCAP OCAP REF.	RIF. ORIG O.E. NUMBER	NOTE REMARKS	MODELLO / DESCRIZIONE MODEL / DESCRIPTION
0909991 	81953020077 81953020077		
0907217 	81432306060 81432306060	L=245 K=48,6 D=70	











TESTE COMANDO CAMBIO - GEAR BOX CONTROL BALL JOINTS

RIF. OCAP OCAP REF.	RIF. ORIG O.E. NUMBER	NOTE REMARKS	MODELLO / DESCRIZIONE MODEL / DESCRIPTION
0287294 	90804105207 90804105207	L=35 M=10x1	CENTROLINER
0187228 	81953016266 81953010038 81953016169 81953016172 81953016176 81953016266 81953016235 81953016302	L=85 M=14 x 1,5 RH	R FRH 362-R R 292 - FR 292-FRH 292 - SG SG 220-SG 242 - SL SL 200 - SR SR 240/280 - SUSU 240/242/272/292/322
0287229 	81953016173 81953016064 81953016130 81953016170 81953016173	L=55 M=12x1,75 RH	EL - EM - LION'S COACH-LION'S STAR - NG - NL . NM - MU - R FRH - SG - SL - SR - SU -UL
0297229 	81953016174 81953016063 81953016131 81953016171 81953016174	L=55 M=12x1,75 LH	EL - EM - LION'S COACH-LION'S STAR - NG - NL . NM - MU - R FRH - SG - SL - SR - SU -UL









COMPONENTI - COMPONENTS

RIF. OCAP OCAP REF.	RIF. ORIG O.E. NUMBER	NOTE REMARKS	MODELLO / DESCRIZIONE MODEL / DESCRIPTION
1216332 	81962100447 81962100447		
1216335 	81442040020 81442040020		







BARRE ACCOPPIAMENTO - TIE RODS

RIF. OCAP OCAP REF.	RIF. ORIG O.E. NUMBER	NOTE REMARKS	MODELLO / DESCRIZIONE MODEL / DESCRIPTION
0507433 	6293200189 0003201232 6283201489 6293200189 6323200232 6323200532	L=200	BUS INTEGRO O 550 - TRAVEGO O 580 - CITARO O 530 - CONECTO O 345
0507421 	6273300103 6273300103 8226330000 8226330000C		SETRA 200 S - 300 S
0507429 	8226347000 6273300303 8226347000 8226247000C	L=484 T=40	EVOBUS: KASSBOHRER - SETRA 300
0508940 	6284602005 6284602005	L=566 T=36	CAPACITY 0530 - CITARO O530 - SETRA MULTICLASS 400
0507425  0287881 M=30x1,5 RHT	8226308000 4103300303 4103300503 8226248000C 8226308000 8226308000C 8226381000	L=630 T=38	EVOBUS: KASSBOHRER - SETRA 300-400
0502259  0182259 M=24x1,5 RHT	6313300603 6313300603	L = 668	100 City
0507424  0187146 M=30x1,5 RHT 0197146 M=30x1,5 LHT	6344600505 6344600505 8226244000D 8226258000C 8226306000	L=670 T=40	SETRA 400
0507423 	6273300203 6273300203 A6273300203 82263260000 82263280000		SETRA 300 S
0507600  0187137 M=24x1,5 RHT 0197137 M=24x1,5 LHT	3563300003 3563300003 6133300003	L=697 T=32	O 403 - O 404 - O 405 - TOURISMO O 350
0508946 	6283300503 6283300503	L=768 T=38	CAPACITY 0530 - CITARO O530 - SETRA MULTICLASS 400







BARRE ACCOPPIAMENTO - TIE RODS

RIF. OCAP OCAP REF.	RIF. ORIG O.E. NUMBER	NOTE REMARKS	MODELLO / DESCRIZIONE MODEL / DESCRIPTION
0507786  0186595 M=24x1,5 RHT 0196595 M=24x1,5 LHT	3163300603 3163300603 3163300203 3163300503 3163300703	L=1454	LP LPO: 608-709
0507792  0186424 M=30x1,5 RHT 0196424 M=30x1,5 LHT	6763300803 6763300803 6763301003 673300503 6763300303	L=1546	L/LN2: - 814F/L/S-817F/L/S/S-914/K/KO-917/K/KO - 1114/K/L/S-1117/K/L/S/S-1120/F/L/L/S/S - 1124/F-1317/K - O 301 - O 402
0507790  0186613 M=28x1,5 RHT 0196613 M=28x1,5 LHT	6763300703 6763300703 6763300203 6763300403 6763300603 6763300903	L=1550	814 O-814 LO - 817 O-817 LO
0507653  0186612 M=24x1,5 RHT 0196612 M=24x1,5 LHT	6703300203 6703300203 6703300303	L=1594	O 609 D- O 611 D- O 614 D - ATEGO BUS - VARIO O 810-O 812-O 814-O 815
0507657  0186424 M=30x1,5 RHT 0196424 M=30x1,5 LHT	3853301403 3853301403	L=1611	KASSB. EVOBUS
0507654  0186424 M=30x1,5 RHT	3023301803 3023301803 3023300303 3023300603	L=1622	O 302
0507644  0186424 M=30x1,5 RHT	3573300803 3573300803 3573300903 3573301403	L=1689	O 405-O 405 ST-O 405 N-O 405 G - O 405 GN-O 405 GTD
0507619  0287136 M=35x1,5 RHT 0297136 M=35x1,5 LHT	3573301503 3573301103 3573301503 6713300003 3053300403 3053300803 3053301003	L=1705 T=40	O 405

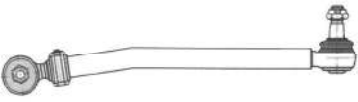







BARRE ACCOPPIAMENTO - TIE RODS

RIF. OCAP OCAP REF.	RIF. ORIG O.E. NUMBER	NOTE REMARKS	MODELLO / DESCRIZIONE MODEL / DESCRIPTION
0507742  0186424  M=30x1,5 RHT	3573300603 3573300603 3573300703	L=1725 T=50	O 405 O 405 G-GN-N-ST
0507435  0187435  M=30x1,5 RHT	6283300103 3823300403 6283300003 6283300103	L=1733 T=62	CITARO O 530
0507616  0287136  M=35x1,5 RHT 0297136  M=35x1,5 LHT	3573300503 3573300503 3573300203 3573300403 3573301603	L=1740 T=40	O 405 - O 407 - O 408









TIRANTI LONGITUDINALI - DRAG LINKS

RIF. OCAP OCAP REF.	RIF. ORIG O.E. NUMBER	NOTE REMARKS	MODELLO / DESCRIZIONE MODEL / DESCRIPTION
0507606  0187342 M=24x1,5 RHT	3134600105 3134600005 3134600105	L=490 T=28	O 309 - T2/L
0507659  0186613 M=28x1,5 RHT	6704602605 6704602605 6704602705	L=495	O 611- O 614
0507624  0186613 M=28x1,5 RHT	6704602805 6704602805 6704602905	L=495 T=32	O 611- O 614
0507898  0186613 M=28x1,5 RHT	6704602205 6704602205 6704601805 6704600905	L=505 T=32	T2/LN1 O 609 D - Per veicoli con guida a destra - For RHD vehicles only
0507144  0186424 M=30x1,5 RHT	3563300103 3563300103 6133300103	L=506	O 350 - O 404
0508942  0186424 M=30x1,5 RHT	6284601905 6284601905	L=658	
0507140  0186424 M=30x1,5 RHT	3004600205 3004600205 3004600305 3014600005 3014600105	L=658	O 303-O 305-O 305G-O 307
0507661  0186424 M=30x1,5 RHT	3734600905 3734600905 3024600505 3024600605 3024603905 3024604005 3734600605	L=687	O 302





TIRANTI LONGITUDINALI - DRAG LINKS

RIF. OCAP OCAP REF.	RIF. ORIG O.E. NUMBER	NOTE REMARKS	MODELLO / DESCRIZIONE MODEL / DESCRIPTION
<p>0506581</p>  <p>0187146 M=30x1,5 RHT</p>	<p>6754602405 6754602405 6754601205 6754601805 6754603005</p>	L=727	O 817-O 1114-O 1117-O 1120
<p>0506576</p>  <p>0187146 M=30x1,5 RHT</p>	<p>6754602205 6754602205 6754601005 6754601605 6754602805</p>	L=780	O 1114-O 1117-O 1120 - O1320 G.Sn/LHD
<p>0506577</p>  <p>0187146 M=30x1,5 RHT</p>	<p>6764601105 6764601105 6764600105 6764600605 6764601505</p>	L=780	O 1120 L G.Sn./LHD - O 1114-O 1117
<p>0507428</p>  <p>0186551 M=30x1,5 RHT</p>	<p>4104600005 4103300205 8226380000 8226380000C</p>	L=870 T=38	SETRA 300 S - 400 S
<p>0507426</p> 	<p>3574603205 3574603205 3574602505 6714600105 6714600305 A3574603205</p>	L=920 T=36	O 405 - CONECTO O 345
<p>0507430</p> 	<p>6284600305 6284600305 6284601205 A6284600305 A6284601205</p>	L=928 T=42	CITARO O 530 - CONECTO O 345
<p>0507139</p>  <p>0186424 M=30x1,5 RHT</p>	<p>3004600605 3004600605 3004600705 3054600305</p>	L=975	O 303-O 305-O 305 G/ST-O 307 - KASSB. EVOBUS
<p>0507667</p>  <p>0186424 M=30x1,5 RHT</p>	<p>3734600705 3734600705 3024600305 3024603505 3024603605 3734600505 3734600305</p>	L=976	373 - O 302/S









TIRANTI LONGITUDINALI - DRAG LINKS

RIF. OCAP OCAP REF.	RIF. ORIG O.E. NUMBER	NOTE REMARKS	MODELLO / DESCRIZIONE MODEL / DESCRIPTION
0507143  0186424 M=30x1,5 RHT	3734600505 3734601005 3734600705 3734600505	L=976	O 340
0507141  0186424 30x1,5 RHT	3574601005 3574601005 3574601105	L=988	O 405-O 407-O 408
0507438  0186424 M=30x1,5 RHT 0196598 M=30x1,5 LHT	3564600205 3564600205 3574602205	L=1007 T=38	O 404 - O 405
0507645  0186424 M=30x1,5 RHT	3574601405 3574601405 3574601505	L=1066	O 405-O 407-O 408
0507138  0186424 M=30x1,5 RHT	3004600405 3004600405 3004600505	L=1146	O 303 - O 340 Turismo - KASSB. EVOBUS
0507422  0186598 M=30x1,5 RHT 0196598 M=30x1,5 LHT	3574603105 3574602405 3574603105 6714600005 6714600205 A3574602405 A3574603105	L=1160 T=38	O 405 - CONECTO O 345
0507142  0186424 M=30x1,5 RHT	3574601205 3574601205 3054600605 3574601305	L=1160	O 307 - O407 - O 408
0507685  0287907 M=52x1,5 RHT	3574602005 3574602005 3574602305	L=1260 T=60	O 405









TIRANTI LONGITUDINALI - DRAG LINKS

RIF. OCAP OCAP REF.	RIF. ORIG O.E. NUMBER	NOTE REMARKS	MODELLO / DESCRIZIONE MODEL / DESCRIPTION
<p>0507432</p>  <p>0186598 M=30x1,5 RHT</p>	<p>6284600205 6284600205 6284601105 A6284600205</p>	<p>L=1271 T=60</p>	<p>CITARO O 530 - CONECTO O 345</p>
<p>0507431</p>  <p>0186598 M=30x1,5 RHT 0196598 M=30x1,5 LHT</p>	<p>3574603505 3574603505 A3574603505 9423301003 9423301703 9423302503</p>	<p>L=1280 T=38</p>	<p>ACTROS MP2 - AXOR 2 - BUS O 405</p>
<p>0507652</p>  <p>0180729 M=24x1,5 RHT 0190729 M=24x1,5 LHT</p>	<p>3093301903 3093301903 3093301203 3093301403 3093301603 3093301703 3093301803 3093302003 3093302103</p>	<p>L=1476</p>	<p>O 309 - KASSB. EVOBUS</p>
<p>0507427</p> 	<p>8226355000 6264600005 8226355000 82262800000 82263550000 8226280000B 8226280000C</p>		<p>EVOBUS S 310</p>







TESTE STERZO - TIE RODS END

RIF. OCAP OCAP REF.	RIF. ORIG O.E. NUMBER	NOTE REMARKS	MODELLO / DESCRIZIONE MODEL / DESCRIPTION
0281904 	6384600048 6384600048	L=75 M=16x1,5 RHT	VITO Bus - SPRINTER Bus
0287361 	0004634429 0004634429 0009964845 0014607048 A0004634429 A0009964845	L=75 M=26x1,5 RHT	INTEGRO O 550 - TOURISMO O 350 - TRAVEGO O 580
0281503 	9014600348 9014600348 9014600048 9014600148	L=76 M=16x1,5 RHT	SPRINTER Bus
0287360 	0014606948 0014606948	L=90 M=26x1,5 RHT	INTEGRO O 550 - TOURISMO O 350 - TRAVEGO O 580
0182260 	0013304835 0013304835 0004607248 4603300435 4603301235 4603301335 6313380510	L=95 M=20x1,5 RHT	100 - O 100 City
0182261 	0004606548 0004606548	L=95 M=18x1,5 RHT	O 100 City
0180730 	0004608548 3103301335 0004608548 0004604148 0003305035 0004602148 0004604548 0004604348	L=95 M=22x1,5 RHT	O 309 - T1: - 601-602
0186595 	0003308535 0003308535 0003300335 0003300635 0003302410 0004633229 0003308735 0003306735	L=95 M=24x1,5 RHT	
0196595 	0003308635 0003308635 0003300235 0003300735 0003308835 0003306835	L=95 M=24x1,5 LHT	



TESTE STERZO - TIE RODS END

RIF. OCAP OCAP REF.	RIF. ORIG O.E. NUMBER	NOTE REMARKS	MODELLO / DESCRIZIONE MODEL / DESCRIPTION
0186612 	0003309735 0003309735 0003309935 0003301235 0003307535 0003383429 0003383529	L=105 M=24x1,5 RHT	O 609 D-O 611 D-O 624 D-O 811 D - VARIO: O 810-O 812 - KASSB. EVOBUS
0196612 	0003309835 0003309835 0003301335	L=105 M=24x1,5 LHT	O 609 D-O 611 D-O 614 D-O 811 D - KASSB. EVOBUS
0186613 	0003309335 0003309335 0003301435 0003301535 0003307135 0003309535 0003382129 0003383629	L=105 M=28x1,5 RHT	LK/LN2: - 814 O-814 LO-817 O-817 LO - O 609 D-O 611 D-O 614 D-811 D - O 814-O 814 L-OF 1113 - KASSB. EVOBUS
0196613 	0003309435 0003309435 0003303335 0003307235 0003309635	L=105 M=28x1,5 LHT	LK/LN2: - 814 O-814 LO-817 O-817 LO - O 609 D-O 611 D-O 614 D-811 D - O 814-O 814 L-OF 1113 - KASSB. EVOBUS
0187342 	0004604348 0004604348 0003381810 0003305635 0004605648 0004631129 6.851.488.000	L=105 M=24x1,5 RHT	O 309 D
0186424 	0014603448 6851516000 0014603448 0013300235 0013300135 0004633529 0004633429 0004608348 0003383410 0003307335 0003305835 0003303235 0003300248	L=115 M=30x1,5 RH	O 301-O 303-O 305 - O 305G-O307 - O 1114-O 1114L/42 - O1114L/49-O 1117L - KASSB. EVOBUS(Ref.-No 6.851.512.000)
0196424 	0013308835 6851516000 0013308835 0003300148 3023300035 3023300135 3023300235 3023300335	L=115 M=30x1,5 LHT	O 301-O 303-O 305 - O 305G-O 307 - O 1114-O 1114L/42 - O1114L/49-O 1117L - KASSB. EVOBUS(Ref.-No. 6.851.516.000)
0186547 	0013300335 0013300335 0013300435 0003303135 0003308135	L=115 M=30x1,5 RHT	LK/LN2 814 LO - LK/LN2 817 LO - LP LPO 608-709 - O 301-O 402 - O 814-O 814 L-O 817-O 817L - OF 1113

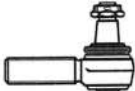

TESTE STERZO - TIE RODS END

RIF. OCAP OCAP REF.	RIF. ORIG O.E. NUMBER	NOTE REMARKS	MODELLO / DESCRIZIONE MODEL / DESCRIPTION
0186551 	0004606848 0004606848 0004605748 0004606048 0004607048 0014601148 0014607648 0014600448 0014601748 0014609648	L=120 M=30x1,5 RHT	
0287881 	6851529000 6851529000 68515290000 1315878	L=120 M=30x1,5 RHT	EVOBUS: KASSBOHRER - SETRA 300-400 SERIES
0186598 	0004602248 0004602848 0004602248 6851484000 0004602948 6851475000 0014600248 6851531000 0004600348 0014600848 0014601248 0004608948 0014600948 0014602248	L=120 M=30x1,5 RHT	CITARO - INTEGRO - TRAVEGO - O 303 - O 317 - O 404 - O 405 - NEOPLAN: - CENTROLINER -TOURLINER - STARLINER - TRANSLINER - TRENDLINER
0196598 	0004603448 0004603448 6851485000 0004600648 0004603548 6851476000 0004601248 0014601448 6851481000 0014600348 0014602348 0014603748	L=120 M=30x1,5 LHT	CITARO - INTEGRO - TRAVEGO - O 303 - O 317 - O 404 - O 405 - NEOPLAN: - CENTROLINER -TOURLINER - STARLINER - TRANSLINER - TRENDLINER
0188934 	0003300827 0003300827	L=120 M=24x1,5 RHT	
0187137 	0004607748 0004607748 0014602148	L=120 M=24x1,5 RHT	O 350 - O 404 - O 405
0197137 	0004607848 0004607848 0014602048	L=120 M=24x1,5 LHT	O 350 - O 404 - O 405











TESTE STERZO - TIE RODS END

RIF. OCAP OCAP REF.	RIF. ORIG O.E. NUMBER	NOTE REMARKS	MODELLO / DESCRIZIONE MODEL / DESCRIPTION
0187146 	6851533000 0004602648 6851533000 0004600148 6851478000 0004602748 6851486000	L=120 M=30x1,5 RHT	KASSB. EVOBUS
0197146 	6851532000 6851523000 6851488000 6851486000 0014607448 0014607548	L=120 M=30x1,5 LHT	KASSB. EVOBUS
0187467 	6.851.491.000 6.851.491.000	L=135	KASSB. EVOBUS
0197467 	6.851.490.000 6.851.490.000	L=135 M=38x1,5 LHT	KASSB. EVOBUS
0287136 	0013302135 0013302135 0013302635 0003304035 0003307735 0003384929 0003302835	L=140 M=35x1,5 RHT	O 302-O 303-O 305 - O 305G-O 307-O 405 ST-O 405 G - O 407 VE-O 408-O 1625 L-O 1628 L - O 340 TOURISMO - KASSB. EVOBUS
0297136 	0013302235 0013302235 0013302735 0003304135 0003307835 0003385029 0003302935	L=140 M=35x1,5 LHT	O 302-O 303-O 305 - O 305G-O 307-O 405 ST-O 405 G - O 407 VE-O 408-O 1625 L-O 1628 L - O 340 TOURISMO - KASSB. EVOBUS
0188994 	6293380010 6293380010	L=140 M=30x1,5 RHT	
0187435 	0014605648 0014605648	L=145	CITARO O 531
0188935 	3103300035 3103300035	L=160	O309 - T2/L - LK
0198935 	3103300135 3103300135	L=160	O309 - T2/L - LK











TESTE STERZO - TIE RODS END

RIF. OCAP OCAP REF.	RIF. ORIG O.E. NUMBER	NOTE REMARKS	MODELLO / DESCRIZIONE MODEL / DESCRIPTION
0180729 	0013300735 0013300735 0003307035 0013301035 0003302735 0013300935 0003300835 0003302635	L=160 M=24x1,5 RHT	
0190729 	0013300835 0013300835 0003302635 0003306935	L=160 M=24x1,5 LHT	
0287907 	0004606748 0004606748	L=168 M=52x1,5 RHT	O 405 O 405 G-ST











BARRE DI REAZIONE - TORQUE RODS

RIF. OCAP OCAP REF.	RIF. ORIG O.E. NUMBER	NOTE REMARKS	MODELLO / DESCRIZIONE MODEL / DESCRIPTION
0808750 	0003301107 0003301107	L=280,5	
0807672 	3563331304 3563331304	L=507 d=15	O 350 TOURISMO - O 404 - O 405 G/GN/N/ST
0907672 	0003501005 0003501005	l=115 p=24 D=55 d=21	
0808973 	6273500206 6273500206	L=576 T=48	CITARO (O530) - CONECTO (O345)
0907906 	0003501513 0003501513	l=130 d=19	
0808974 	6283331105 6283331105	L=576 T=48	CITARO (O530) - CONECTO (O345)
0907407 	0003302011 0003302011	l=130 D1=75 d=19	CITARO (O530) - CONECTO (O345)
0807418 	6003300111 3173500606 3573303411	L=585 T=56	O 303 - O 405
0807882 	3573500306 3573500306	L=585	O 405 O - O 407 O - O 408 O
0907882 	0003300080 0003300080	l=130 p=30 D=87 d=19	
0907883 	0003301611 0003301611	L=70 D=87	











BARRE DI REAZIONE - TORQUE RODS

RIF. OCAP OCAP REF.	RIF. ORIG O.E. NUMBER	NOTE REMARKS	MODELLO / DESCRIZIONE MODEL / DESCRIPTION
0807593 	6283330405 6283330405	L=618 T=42	CITARO O 530
0807594 	3573330405 3573330405 6713330105	L=625 T=36	O 405
0807412 A  A	6293500006 6293501206 6293500106 6293502806 4103500906	L=628 T=48	TRAVEGO O 580 - SETRA 400 - INTEGRO O 550
0907259 A 	0003500506 0003500506 0003300611	l=130 p=30 D=70 d=19	
0807413 A  A	6293500106 6273500006 6273500106 6283330005 6283331005 6283331805	L=658 T=48	CITARO O 530 - CONECTO O 345 - INTEGRO O 550 - SETRA 400
0907259 A 	0003500506 0003500506 0003300611	l=130 p=30 D=70 d=19	
0807590 A  A	6293500606 6293500606 8226293000B 6293500506	L=658 T=48 l=130 d=19	TRAVEGO O 580
0907259 A 	0003500506 0003500506 0003300611	l=130 p=30 D=70 d=19	
0888977 A  A	3573330505 3573330505	L=659	
0907528 A 	0003300707 0003300707	l=115 p=24 D=70 d=17	
0898977 A  A	3573330705 3573330705	L=659	











BARRE DI REAZIONE - TORQUE RODS

RIF. OCAP OCAP REF.	RIF. ORIG O.E. NUMBER	NOTE REMARKS	MODELLO / DESCRIZIONE MODEL / DESCRIPTION
0907528 A 	0003300707 0003300707	l=115 p=24 D=70 d=17	
0807591 A  A	6283330205 6283330205	L=659 l=115 d=17	CITARO O 530 - CONECTO O 345
0907591 A 	0003302111 0003302111	l=115 p=24 D=67 d=17	
0807592 A  A	6283330305 6283330305	L=659 T=46 d=17	CITARO O 530
0907591 A 	0003302111 0003302111	l=115 p=24 D=67 d=17	
0807420  A	8226232000 8226232000 8226241000 8226357000 6293520005	L=660 T=50	SETRA 200 S - KAESSBOHRER
0907259 A 	0003500506 0003500506 0003300611	l=130 p=30 D=70 d=19	
0807415 A  A	8226323000B 8226323000B 8226318000B 8.226.318.000B 8.226.323.000B	L=660 T=48	CONECTO O 345 - EVOBUS S 310
0907259 A 	0003500506 0003500506 0003300611	l=130 p=30 D=70 d=19	
0807542 A  A	3573330905 3573330905 3573330605	L=662 T=40 d=19	O 405 - Citaro N
0907259 A 	0003500506 0003500506 0003300611	l=130 p=30 D=70 d=19	



BARRE DI REAZIONE - TORQUE RODS

RIF. OCAP OCAP REF.	RIF. ORIG O.E. NUMBER	NOTE REMARKS	MODELLO / DESCRIZIONE MODEL / DESCRIPTION
0807416 A  A	6283330005 6283330005 6283331005 6283331805 6273500106 6283330003 6323500306	L=664 T=48	CITARO O 530 - CONECTO O 345
0907259 A 	0003500506 0003500506 0003300611	l=130 p=30 D=70 d=19	
0808748 	6443500305 6443500305	L=664 T=46	
0808978 A  A	3573301911 3573301911	L=713 T=56	
0908978 A 	0003300075 0003300075		
0807417 	6003300111 3173500706 3593300011 3643307411 6003300111 6643307211 6653307411	L=724 T=56	O 303 - O 340
0807411 A  A	6293500006 6293500006 6293500105 6293501106	L=725 T=48	TRAVEGO O 580 - SETRA 400
0907259 A 	0003500506 0003500506 0003300611	l=130 p=30 D=70 d=19	
0807822 A  A	3573330205 3573330205 6713330005	L=70 T=48 l=130 d=19	O 405 O 405 O G-ST
0907259 A 	0003500506 0003500506 0003300611	l=130 p=30 D=70 d=19	











BARRE DI REAZIONE - TORQUE RODS

RIF. OCAP OCAP REF.	RIF. ORIG O.E. NUMBER	NOTE REMARKS	MODELLO / DESCRIZIONE MODEL / DESCRIPTION
0807414 A  A	3563300211 3563300211 6133300011		O 404
0907414 A 	0003501305 0003501305	l=130 d=17	
0807419 	3573303111 3223301011 3573303111	L=775 T=56	O 303 - O 405 - O 407 - O 408
0807531 A  B	3573330101 3573330101	L=806 d=17	O 405 O
0907217 A 	0003300107 0003300107	L=245 K=48,6 D=70	CITARO (O530)
0907528 B 	0003300707 0003300707	l=115 p=24 D=70 d=17	
0808979 A  B	6283330101 3573330101	L=806 d=17	CITARO (O530)
0907217 A 	0003300107 0003300107	K=48,6 D=70	CITARO (O530)
0907528 B 	0003300707 0003300707	l=115 p=24 D=70 d=17	CITARO (O530)
0888988 B  B	3563301510 3563301510	L=901/800	O 404
0908988 B 	0003300410 0003300410		O 404







BARRE DI REAZIONE - TORQUE RODS

RIF. OCAP OCAP REF.	RIF. ORIG O.E. NUMBER	NOTE REMARKS	MODELLO / DESCRIZIONE MODEL / DESCRIPTION
<p>0898988</p> 	<p>3563301410 3563301410</p>	<p>L=901/800</p>	<p>O 404</p>
<p>0908988</p> 	<p>0003300410 0003300410</p>		<p>O 404</p>

KIT DI SOSPENSIONE - SUSPENSION KITS

RIF. OCAP OCAP REF.	RIF. ORIG O.E. NUMBER	NOTE REMARKS	MODELLO / DESCRIZIONE MODEL / DESCRIPTION
0908989 	0003302511 0003302511	l=90	
0907672 	0003501005 0003501005	l=115 p=24 D=55 d=21	O 404 O - O 405 O - O 305 Turismo
0907327 	0003300207 0003300207	l=130 p=24 D=62 d=19	
0907362 	0003500906 0003500906	l=130 D=85 d=19	O 405 - TOURISMO O 350
0907591 	0003302111 0003302111	l=115 p=24 D=67 d=17	CITARO O 530 - CONECTO O 345
0907882 	0003300080 0003300080	l=130 p=30 D=87 d=19	O 405 O - O 407 O - O 408 O
0907883 	0003301611 0003301611	L=70 D=87	O 405 O - O 407 O - O 408 O
0907407 	0003302011 0003302011	l=130 D1=75 d=19	CITARO O 530 - CONECTO O 345
0907531 	0003300107 0003300107	L=245 K=48,6 D=70	O 405 O
0907259 	0003500506 0003500506 0003300611	l=130 p=30 D=70 d=19	INTEGRO - TOURISMO - TRAVEGO - O 405
0907906 	0003501513 0003501513	l=130 d=19	













KIT DI SOSPENSIONE - SUSPENSION KITS

RIF. OCAP OCAP REF.	RIF. ORIG O.E. NUMBER	NOTE REMARKS	MODELLO / DESCRIZIONE MODEL / DESCRIPTION
0907528 	0003300707 0003300707	l=115 p=24 D=70 d=17	CITARO - O 405 - O 407 - O 408
0907414 	0003501305 0003501305	l=130 d=17	O 404
0908978 	0003300075 0003300075	l=130 p=30	
0907217 	0003300107 0003300107	L=245 K=48,6 D=70	
0908988 	0003300410 0003300410		O 404
0908992 	0003500905 0003500905	D=95	O 404



SNODI SOSPENSIONI - SUSPENSION JOINTS

RIF. OCAP OCAP REF.	RIF. ORIG O.E. NUMBER	NOTE REMARKS	MODELLO / DESCRIZIONE MODEL / DESCRIPTION
<p>0402159</p> 	<p>0003200028 6313200228 0003200028 0003200128 6083200028 6083200128 6313200028 6313200128</p>		<p>100 - O 100 CITY - T1 - HENSCHEL 2t</p>



STABILIZZATORI - STABILIZERS

RIF. OCAP OCAP REF.	RIF. ORIG O.E. NUMBER	NOTE REMARKS	MODELLO / DESCRIZIONE MODEL / DESCRIPTION
0588936 	0003200132 0003200132	L=148	INTEGRO - TRAVEGO - SETRA 400
0598936 	0003200232 0003200232	L=148	INTEGRO - TRAVEGO - SETRA 400
0587980 	6283201189 6283201189	L=260 M=20x1,5 RHT	CITARO O 530
0597980 	6283201089 6283201089	L=260 M=20x1,5 RHT	CITARO O 530
0587981 	6283201389 6283201389	L=260 M=20x1,5 RHT	CITARO O 530 - CONECTO O 345
0597981 	6283201389 6283201389	L=260 M=20x1,5 RHT	CITARO O 530 - CONECTO O 345
0587982 	6283200289 6283200289	L=260 T=36	CITARO O 530
0597982 	6283200089 6283200089	L=260 T=36	CITARO O 530
0587983 	6283200389 6283200389	L=260 T=36	CITARO O 530 - CONECTO O 345
0597983 	6283200189 6283200189	L=260 T=36	CITARO O 530 - CONECTO O 345
0588937 	6343260116 6343260116	L=300 T=36	TOURO - O500
0598937 	6343260016 6343260016	L=300 T=36	TOURO - O500

STABILIZZATORI - STABILIZERS

RIF. OCAP OCAP REF.	RIF. ORIG O.E. NUMBER	NOTE REMARKS	MODELLO / DESCRIZIONE MODEL / DESCRIPTION
0588938 	6343260316 6343260316	L=375 T=36	TOURO - 0500
0598938 	6343260216 6343260216	L=375 T=36	TOURO - 0500















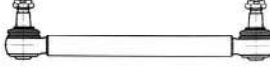





KIT PERNO FUSO - KING PIN SET

RIF. OCAP OCAP REF.	RIF. ORIG O.E. NUMBER	NOTE REMARKS	MODELLO / DESCRIZIONE MODEL / DESCRIPTION
<p>0927432</p> 	<p>3553300319 3553300319 3555860033</p>	<p>L=219 D=45</p>	<p>303 O</p>
<p>0927436</p> 	<p>3913300019 3913300019 3915860033 3895860033</p>	<p>L=222,5 D=50/51</p>	<p>ASSE ANTERIORE/FRONT AXLE: - 303 O-305 O /G-307 O</p>



COMPONENTI - COMPONENTS

RIF. OCAP OCAP REF.	RIF. ORIG O.E. NUMBER	NOTE REMARKS	MODELLO / DESCRIZIONE MODEL / DESCRIPTION
<p>1216339</p> 	<p>3963260081 3963260081</p>	<p>I=103</p>	<p>OH-0404-TOURISMO O350</p>





















BARRE ACCOPPIAMENTO - TIE RODS

RIF. OCAP OCAP REF.	RIF. ORIG O.E. NUMBER	NOTE REMARKS	MODELLO / DESCRIZIONE MODEL / DESCRIPTION
0507481   0187460 M=30x1,5 RHT  0196598 M=30x1,5 LHT	122352700 122352700 11020291	L=261	
0507954 	81467116898 81467116886 81467116897 81467116898 81467116899	L=429 T=36	STARLINER N 5218 - TRENDLINER N 3516
0507482 	122352720 122352720 11020292	L=500	
0507483   0186598 M=30x1,5 RHT  0196598 M=30x1,5 LHT	122352740 122352740	L=627	
0507474   0186598 M=30x1,5 RHT  0196598 M=30x1,5 LHT	120328300 120328300 11019692	L=660	
0507743   0186598 M=30x1,5 RHT  0196598 M=30x1,5 LHT	81467116874 81467116770 81467116772 81467116874 81467116875 81467116876	L=660 T=36	CENTROLINER - CITYLINER - STARLINER - TOURLINER - TRENDLINER
0507473   0186598 M=30x1,5 RHT  0196598 M=30x1,5 LHT	120325800 120325800	L=900	
0507468   0186598 M=30x1,5 RHT  0196598 M=30x1,5 LHT	120322809 120322809 11019632	L=940	

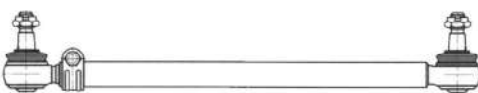

BARRE ACCOPPIAMENTO - TIE RODS

RIF. OCAP OCAP REF.	RIF. ORIG O.E. NUMBER	NOTE REMARKS	MODELLO / DESCRIZIONE MODEL / DESCRIPTION
<p>0507471</p>  <p>0186598 M=30X1,5 RHT 0196598 M=30x1,5 LHT</p>	<p>120324500 120324500</p>	<p>L=1045</p>	
<p>0507469</p>  <p>0186598 M=30x1,5 RHT 0196598 M=30x1,5 LHT</p>	<p>120322812 120322812 11019635</p>	<p>L=1762</p>	

TIRANTI LONGITUDINALI - DRAG LINKS

RIF. OCAP OCAP REF.	RIF. ORIG O.E. NUMBER	NOTE REMARKS	MODELLO / DESCRIZIONE MODEL / DESCRIPTION
0507477   0186598 M=30x1,5 RHT  0196598 M=30x1,5 LHT	122350000 122350000 11020274	L=300	
0507472   0186598 M=30x1,5 RHT  0196598 M=30x1,5 LHT	120325500 120325500 11019664	L=610	
0507791 	81466116045 81466116045	L=628 T=40	CENTROLINER
0507480   0186598 M=30x1,5 RHT  0196598 M=30x1,5 LHT	122351600 122351600 11020285	L=753	
0507470   0186598 M=30x1,5 RHT  0196598 M=30x1,5 LHT	120323000 120323000 11019641 21041	L=840	316 Transliner
0507479   0186598 M=30x1,5 RHT  0196598 M=30x1,5 LHT	122351500 122351500	L=900	
0507139   0186424 M=30x1,5 RHT	3004600605 3004600605 3004600705 3004600305 3054600305	L=975	O 303 - O 305 - O 307
0507138   0186424 M=30x1,5 RHT	3004600405 3004600405 3004600505 3014600505	L=1146	O 303 - O 340 - O 340 TOURISMO







TIRANTI LONGITUDINALI - DRAG LINKS

RIF. OCAP OCAP REF.	RIF. ORIG O.E. NUMBER	NOTE REMARKS	MODELLO / DESCRIZIONE MODEL / DESCRIPTION
0507952  0186758  M=30x1,5 RHT	81466116085 36466106007 36466106033 81466106794 81466116044 81466116085 81466116108 81466116114 81466116120	L=1358 T=52	CENTROLINER N 4516-4522

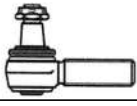

TESTE STERZO - TIE RODS END

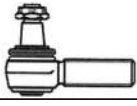
RIF. OCAP OCAP REF.	RIF. ORIG O.E. NUMBER	NOTE REMARKS	MODELLO / DESCRIZIONE MODEL / DESCRIPTION
0187465 	120110403 120110403	L=75 M=22x1,5 RHT	
0287361 	122162800 122162800 11019859	L=75 M=26x1,5 RHT	
0287466 	120110404 120110404 0004632329 0004632629	L=90 M=22x1,5 RHT	
0287291 	120164610 120164610	L=95 M=24x1,5 RHT	
0186613 	120325701 120325701	L=105 M=28x1,5 RHT	
0196613 	120325702 120325702	L=105 M=28x1,5 LHT	
0186612 	120324001 120324001	L=105 M=24x1,5 RHT	
0196612 	120324002 120324002	L=105 M=24x1,5 LHT	
0187342 	120326100 120326100	L=105 M=24x1,5 RHT	O 309 D
0197342 	120326200 120326200	L=105 M=24x1,5 LHT	O 309 D
0187460 	- -	L=105 M=30x1,5 RHT	

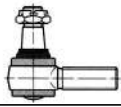
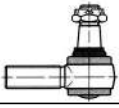
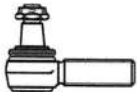

TESTE STERZO - TIE RODS END

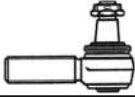
RIF. OCAP OCAP REF.	RIF. ORIG O.E. NUMBER	NOTE REMARKS	MODELLO / DESCRIZIONE MODEL / DESCRIPTION
0186424 	082192300 082192300 0013300135 120325101 11015686	L=115 M=30x1,5 RHT	O 301-O 303-O 340-O 340 TOURISMO - O 402-O 405 G/GN/GTD - O 405 N/ST - O 407- O 408
0196424 	082192200 082192200 3023300235 120325100 0003300148 11015685 3023300035 3023300135 3023300335	L=115 M=30x1,5 LHT	O 301-O 303-O 340-O 340 TOURISMO - O 402-O 405 G/GN/GTD - O 405 N/ST - O 407- O 408
0187571 	120326400 120326400	L=115 M=30x1,5 RHT	608-709-808 - 814-814 L - 817 LO-817 O
0186598 	120325000 120325000 11926 11019659	L=120 M=30x1,5 RHT	N 122/3 Skyliner - N 116-N 316 Transliner - N 516 SHD Starliner - N 4021 Standard
0196598 	120325200 120325200 11927 11019661	L=120 M=30x1,5 LHT	N 122/3 Skyliner - N 116-N 316 Transliner - N 516 SHD Starliner - N 4021 Standard
0187146 	120326000 120326000	L=120 M=30x1,5 RHT	
0186758 	81953010022 81953010022 0696226 0609643 0586714 0609634 0607073 1337367	L=135 M=30x1,5 RHT	CENTROLINER N 4516-4522
0187463 	122169000 122169000 11019933	L=135 M=38x1,5 RHT	
0197463 	122169100 122169100	L=135 M=38x1,5 LHT	
0187467 	120322305 120322305	L=135 M=38x1,5 RHT	

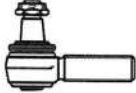





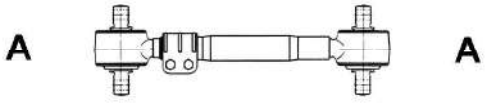
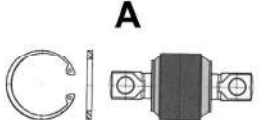
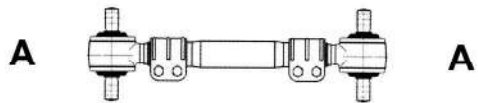
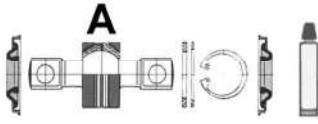
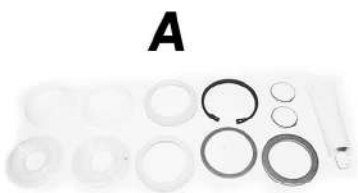
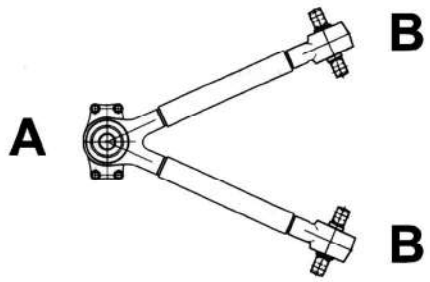

TESTE STERZO - TIE RODS END

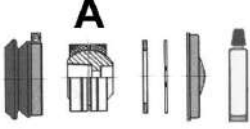
RIF. OCAP OCAP REF.	RIF. ORIG O.E. NUMBER	NOTE REMARKS	MODELLO / DESCRIZIONE MODEL / DESCRIPTION
0197467 	120322300 120322300	L=135 M=38x1,5 LHT	
0287136 	0013302135 0013302135 0003304035 0003307735 0003384929 0013302635	L=140 M=35x1,5 RHT	O 303-O 307 - O 340-O 340 TOURISMO - O 405-O 407-O 408
0297136 	0013302235 0013302235 0003301935 0003302935 0003304135 0003307835 0003385029 0013302735	L=140 M=35x1,5 LHT	O 303-O 307 - O 340-O 340 TOURISMO - O 405-O 407-O 408
0187476 	122169500 122169500 11019966	L=150 M=38x1,5 RHT	

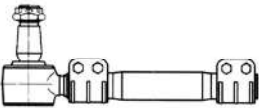
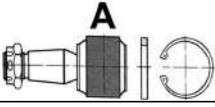





BARRE DI REAZIONE - TORQUE RODS

RIF. OCAP OCAP REF.	RIF. ORIG O.E. NUMBER	NOTE REMARKS	MODELLO / DESCRIZIONE MODEL / DESCRIPTION
0807816 	81432206177 81432206177	L=330 T=36	CENTROLINER N 4420 - 4421
0909984 	81432206224 * 81432206224 *		CENTROLINER N 4420 - 4422
0907816 	81432206177 * 81432206177 *		CENTROLINER N 4420 - 4423
0807357 	082751110 082751110	L=540 d=17	
0907484 	- -	l=115 p=24 D=62 d=17	
0807478 	122351400 122351400	L=700 d=21	
0907556 	- -	l=152 p=24 D=65 d=21	
0907586 	0005861533 0005861533	D=65	senza perno (without pin)
0807354 	082750900 082750900 11015863	L=750 d=19	





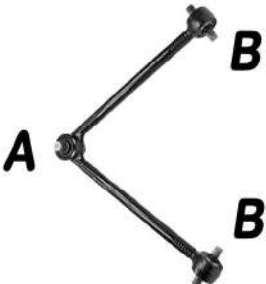

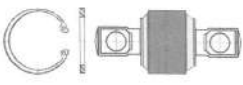
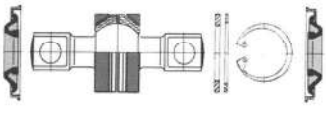

BARRE DI REAZIONE - TORQUE RODS

RIF. OCAP OCAP REF.	RIF. ORIG O.E. NUMBER	NOTE REMARKS	MODELLO / DESCRIZIONE MODEL / DESCRIPTION
0907257 	082750905 082750905	D=65 IK=38	
0907259 	81432206055 070550504 11013547 81432206396 81432206409 81432206189	l=130 p=30 D=70 d=19	
0807464 	082756320 082756320	L=790	
0907485 	- -	D=70 K=45	
0807408 	81432206189 81432206396 81432206409 81432206189	L=614 T=48 l=130 d=19	CENTROLINER
0907259 	81432206055 070550504 11013547 81432206396 81432206409 81432206189	l=130 p=30 D=70 d=19	
0807806 	81432206215 81432206215	L=413 d=15 l=80	CENTROLINER
0807808 	81432206145 81432206145	L=531 T=48	CENTROLINER N 4516
0907259 	81432206055 070550504 11013547 81432206396 81432206409 81432206189	l=130 p=30 D=70 d=19	
0807821 	81432206161 81432206161 81432206190	L=531 T=50 l=130 d=19	CENTROLINER

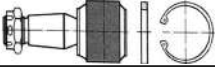
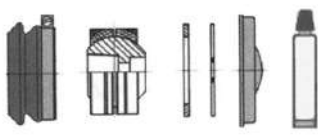

BARRE DI REAZIONE - TORQUE RODS

RIF. OCAP OCAP REF.	RIF. ORIG O.E. NUMBER	NOTE REMARKS	MODELLO / DESCRIZIONE MODEL / DESCRIPTION
0907259 A 	81432206055 070550504 11013547 81432206396 81432206409 81432206189	l=130 p=30 D=70 d=19	
0807823 A 	81432206183 81432206151 81432206183 81432206276	L=570 T=48 l=130 d=19	STARLINER - CENTROLINER - CITYLINER - TOURLINER - TRENDLINER
0907259 A 	81432206055 070550504 11013547 81432206396 81432206409 81432206189	l=130 p=30 D=70 d=19	
0807832 A  A	81432206279 81432206258 81432206264 81432206275 81432206278 81432206279	L=622 T=48 l=130 d=19	CENTROLINER - CITYLINER - STARLINER - TOURLINER
0907362 A 	81432706127 5001850588 5000333285 5001860300 5010393047 42536819 81432206369 81432206250		
0807844 	81433156037 81433156037 81433156036	L=782 T=48	CENTROLINER
0907844 A 	81433150009 81433150009	l=145 p=35 D=95 d=19	
0907845 B 	81432706133 81432706133 5001847026	l=130 p=30 D=85 d=21	





KIT DI SOSPENSIONE - SUSPENSION KITS

RIF. OCAP OCAP REF.	RIF. ORIG O.E. NUMBER	NOTE REMARKS	MODELLO / DESCRIZIONE MODEL / DESCRIPTION
0907484 	- -	l=115 p=24 D=62 d=17	
0907556 	- -	l=152 p=24 D=65 d=21	
0907586 	0005861533 0005861533	D=65	senza perno (without pin)
0907485 	- -	D=70 K=45	
0907257 	082750905 082750905	D=65 IK=38	-
0907845 	81432706133 81432706133 5001847026	l=130 p=30 D=85 d=21	CENTROLINER
0907259 	070550504 070550504 11013547 81432206396 81432206409 81432206189	l=130 p=30 D=70 d=19	TRANSLINER - CENTROLINER - STARLINER - CITYLINER - TOURLINER - TRENDLINER
0907407 	85432206002 85432206002 500333284 0003302011	l=130 d=19	CENTROLINER - STARLINER - TRENDLINER
0907362 	81432706127 5001850588 5000333285 5001860300 5010393047 42536819 81432206369 81432206250		CENTROLINER - CITYLINER - TOURLINER - TRENDLINER
0907623 	082751027 082751027		







KIT DI SOSPENSIONE - SUSPENSION KITS

RIF. OCAP OCAP REF.	RIF. ORIG O.E. NUMBER	NOTE REMARKS	MODELLO / DESCRIZIONE MODEL / DESCRIPTION
0907844 	81433150009 81433150009	l=145 p=35 D=95 d=19	CENTROLINER
0909984 	81432206224 * 81432206224 *		CENTROLINER N 4420 - 4422
0907816 	81432206177 * 81432206177 *		CENTROLINER N 4420 - 4422

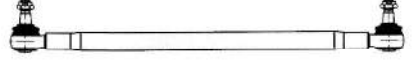

BARRE ACCOPPIAMENTO - TIE RODS

RIF. OCAP OCAP REF.	RIF. ORIG O.E. NUMBER	NOTE REMARKS	MODELLO / DESCRIZIONE MODEL / DESCRIPTION
0507989 	5010207728 5000761673 5010104286 5010207728	L=555 T=36	FR1 - ILIADE
0508737   0186424 M=30x1,5 RHT	5010347549 5010347549	L=1675 T=50	AGORA - CRISTALIS - GX
0507986   0186598 M=30x1,5 RHT	5010190148 5010190148 0000755676	L=1855 T=40	PR 100-110-180 - GX 107







TIRANTI LONGITUDINALI - DRAG LINKS

RIF. OCAP OCAP REF.	RIF. ORIG O.E. NUMBER	NOTE REMARKS	MODELLO / DESCRIZIONE MODEL / DESCRIPTION
<p>0508996</p>  <p>0186598 M=30x1,5 RHT</p> <p>0196598</p>	<p>5010104287 5010104287</p>	<p>L=525</p>	
<p>0507744</p>  <p>0186598 M=30x1,5 RH</p>	<p>5001829030 5001829030 5000786768</p>	<p>L=642</p>	<p>PR14</p>
<p>0506693</p>  <p>0186424 M=30x1,5 RHT</p>	<p>5010174787 5000932435 5010174787</p>	<p>L=985</p>	<p>Gamma S45/S53 A.R. - Gamma S45/S53 A.V.</p>
<p>0506694</p>  <p>0186598 M=30x1,5 RHT</p>	<p>5010174785 5000998430 5010174785</p>	<p>L=1200</p>	<p>Gamma S45/S53 A.R. - Gamma S45/S53 A.V.</p>
<p>0507678</p> 	<p>5010207724 5010207724 5010151528 5000761671</p>	<p>L=1475</p>	<p>Gamma FR1</p>
<p>0506692</p>  <p>0186598 M=30x1,5 RHT</p>	<p>5010207725 5010207725 5000761670 5010151529 5000786527 5010104289</p>	<p>L=2085</p>	<p>Gamma FR1- FRH</p>

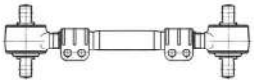

TESTE STERZO - TIE RODS END

RIF. OCAP OCAP REF.	RIF. ORIG O.E. NUMBER	NOTE REMARKS	MODELLO / DESCRIZIONE MODEL / DESCRIPTION
0186424 	5000295214 5000295214 0003406212 0003406242 0003406253 5000242159 5000559335 5000812483 5001831473 7701016946 5001832582	L=115 M=30x1,5 RHT	Gamma: M-S-J
0186598 	5000288360 5000288360 0003401169 0003406236 0003406251 0003406254 0003406260 0003406261 5000590236 5000804824 5001836298 7701011412 5010832582 5001858773	L=120 M=30x1,5 RHT	AE-C-G-R - MAGNUM-PREMIUM

BARRE DI REAZIONE - TORQUE RODS

RIF. OCAP OCAP REF.	RIF. ORIG O.E. NUMBER	NOTE REMARKS	MODELLO / DESCRIZIONE MODEL / DESCRIPTION
0808747  A	5006172093 5006172093	L=454 T=50	IRISBUS
0907845  A	5001847026 5001847026	l=130 p=30 D=85 d=21	IRISBUS
0807673 	5000640089 5000640089 5000869619	L=500 T=40	TRACER
0808739  A A	5010347403 5010347403	L=555 T=48	IRISBUS ACCESS BUS - AGORA
0907259  A	5001842823 5001842823	l=130 p=30 D=70 d=19	IRISBUS ACCESS BUS - AGORA
0807750  A A	5010347099 5010347099	L=575 d=19	ILIADE-ARES
0907259  A	5001842823 5001842823	l=130 p=30 D=70 d=19	-





KIT DI SOSPENSIONE - SUSPENSION KITS

RIF. OCAP OCAP REF.	RIF. ORIG O.E. NUMBER	NOTE REMARKS	MODELLO / DESCRIZIONE MODEL / DESCRIPTION
0907845 	5001847026 5001847026	l=130 p=30 D=85 d=21	IRISBUS
0907259 	5001842823 5001842823	l=130 p=30 D=70 d=19	IRISBUS: - ACCESS - ARWAY - CITELIS - CROSSWAY - EVADYS - ILIADE-ARES

SNODI SOSPENSIONI - SUSPENSION JOINTS

RIF. OCAP OCAP REF.	RIF. ORIG O.E. NUMBER	NOTE REMARKS	MODELLO / DESCRIZIONE MODEL / DESCRIPTION
<p>0407219</p> 	<p>5010393672 5000489779 5010393672</p>	<p>M=30x1,5 RHT</p>	<p>FR1 - ILIADE</p>





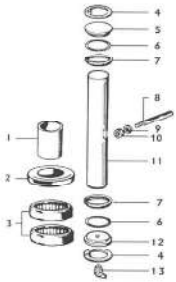

STABILIZZATORI - STABILIZERS

RIF. OCAP OCAP REF.	RIF. ORIG O.E. NUMBER	NOTE REMARKS	MODELLO / DESCRIZIONE MODEL / DESCRIPTION
0587992 	5010151409 5010151409 5000869761	L=120 T=31	FR1 - ILIADE (ANTERIORE - FRONT)
0597992 	5010151410 5010151410 5000786379 5000869762	L=120 T=31	FR1 - ILIADE (ANTERIORE - FRONT)
0507993 	5010151411 5000869763 5010151411	L=120 T=31	FR1 - ILIADE (POSTERIORE - REAR)
0507888 	5010199642 5010199642	L=195	









KIT PERNO FUSO - KING PIN SET

RIF. OCAP OCAP REF.	RIF. ORIG O.E. NUMBER	NOTE REMARKS	MODELLO / DESCRIZIONE MODEL / DESCRIPTION
<p>0927450</p> 	<p>-</p> <p>-</p>	<p>L=277</p> <p>D=50</p>	<p>BUS TRACER</p>

















BARRE ACCOPPIAMENTO - TIE RODS

RIF. OCAP OCAP REF.	RIF. ORIG O.E. NUMBER	NOTE REMARKS	MODELLO / DESCRIZIONE MODEL / DESCRIPTION
<p>0508742</p> 	<p>1755507 1755507</p>	<p>L=538 T=52</p>	<p>SERIE F-K-N-L - IRIZAR PB</p>
<p>0508743</p>  <p>0186598</p> 	<p>1433533 1433533</p>	<p>L=635 T=52</p>	<p>SERIE 4 - IRIZAR PB - F-K-L-N</p>
<p>0508744</p>  <p>0186598</p> 	<p>1433532 1433532</p>	<p>L=635 T=52</p>	<p>SERIE 4 - IRIZAR PB - F-K-L-N</p>
<p>0508758</p>  <p>0187894 M=30x1,5 RHT</p> 	<p>1527989 1527989</p>	<p>L=1743</p>	



TIRANTI LONGITUDINALI - DRAG LINKS

RIF. OCAP OCAP REF.	RIF. ORIG O.E. NUMBER	NOTE REMARKS	MODELLO / DESCRIZIONE MODEL / DESCRIPTION
<p>0508745</p>  <p>0186598 M=30x1,5 RHT</p>	<p>475463 475463</p>	<p>L=870 T=48</p>	IRIZAR PB
<p>0508746</p>  <p>0186598 M=30x1,5 RHT</p>	<p>1432723 1432723</p>	<p>L=882 T=48</p>	IRIZAR PB
<p>0507996</p>  <p>0186598 M=30x1,5 RHT</p>	<p>1755502 1450364 1755502 1895860</p>	<p>L=882 T=48</p>	IRIZAR PB
<p>0507758</p>  <p>0186598 M=30x1,5 RHT</p>	<p>412406 412406</p>	<p>L=898 T=50</p>	SERIE K 113 - F 113 - L113
<p>0507998</p>  <p>0186598 M=30x1,5 RHT</p>	<p>466336 0466336 466336</p>	<p>L=992 T=48</p>	SERIE 3 K 113- F 113 - L113
<p>0507730</p>  <p>0186598 M=30x1,5 RHT</p>	<p>415400 415400 0415400</p>	<p>L=1015</p>	Serie 3 - K 112
<p>0509882</p>  <p>0186960 M=30x1,5 RHT</p>	<p>1197339 1197339</p>	<p>L=1028 T=62</p>	SERIE B10 - B12
<p>0508749</p>  <p>0186598 M=30x1,5 RHT</p>	<p>1533026 1533026</p>	<p>L=1042 T=52</p>	SERIE 4 - F-K-N





TIRANTI LONGITUDINALI - DRAG LINKS

RIF. OCAP OCAP REF.	RIF. ORIG O.E. NUMBER	NOTE REMARKS	MODELLO / DESCRIZIONE MODEL / DESCRIPTION
0508751   0186598 M=30x1,5 RHT	1428193 1428193	L=1042 T=62	SERIE 4 - F-K-N
0508752   0186598 M=30x1,5 RHT	1497223 1497223	L=1044 T=60	SERIE 4 - F-K-N
0506938   0186598 M=30x1,5 RHT	466881 466881	L=1099	SERIE 3: K 113 - Sosp. pneumatiche - (Pneumatic suspension)
0509880   0186598 M=30x1,5 RHT	466880 466880 0466880	L=1105 T=52	SERIE 3 K 113- F 113 - L113
0508754   0186598 M=30x1,5 RHT	1897669 1897669	L=1256 T=62	SERIE 4
0508755   0186598 M=30x1,5 RHT	1897671 1897671	L=1256 T=62	SERIE 4
0507995   0186598 M=30x1,5 RHT	1895858 1479122 1755498 1895858	L=1272 T=62	SERIE K 250-270-310-360-400-410-440
0508756   0186598 M=30x1,5 RHT	1479120 1479120	L=1272 T=62	SERIE K 250-270-310-360-400-410-440











TIRANTI LONGITUDINALI - DRAG LINKS

RIF. OCAP OCAP REF.	RIF. ORIG O.E. NUMBER	NOTE REMARKS	MODELLO / DESCRIZIONE MODEL / DESCRIPTION
<p>0506933</p>  <p>0186598 M=30x1,5 RHT</p>	<p>432698 432698</p>	<p>L=1365</p>	<p>K 113</p>
<p>0507189</p>  <p>0186598 M=30x1,5 RHT</p>	<p>470272 470272</p>	<p>Lt=1335</p>	<p>K 113</p>









TESTE STERZO - TIE RODS END

RIF. OCAP OCAP REF.	RIF. ORIG O.E. NUMBER	NOTE REMARKS	MODELLO / DESCRIZIONE MODEL / DESCRIPTION
0186598 	283784 1358793 283784 468286 395010 1738381 1767328	L=120 M=30x1,5 RHT	SERIE 3: K 93 - K 113 - SERIE 4 - F 113 - L113 - SERIE K 250-270- 310-360-400-410-440
0196598 	283783 283783 395009 468285 1358792 1738380	L=120 M=30x1,5 LHT	SERIE 3: K 93 - K 113 - SERIE 4
0186960 	1695776 1695776 1507826 1695585 1698557	L=120 M=30x1,5 RHT	B 10 - B 12
0187894 	1723897 1723897	L=145 M=30x1,5 RHT	SERIE F-K-N

BARRE DI REAZIONE - TORQUE RODS

RIF. OCAP OCAP REF.	RIF. ORIG O.E. NUMBER	NOTE REMARKS	MODELLO / DESCRIZIONE MODEL / DESCRIPTION
0807451  A A	0477889 0477889 1431471	L=532 T=46 I=115	IRIZAR PB
0907528  A	639370 639370 550799 550806 0639370 1104334 112506 1517403	I=115 p=24 D=62 d=17	
0807452  A A	1438475 1438475 1863130	L=539 T=50 I=115	IRIZAR PB
0907528  A	639370 639370 550799 550806 0639370 1104334 112506 1517403	I=115 p=24 D=62 d=17	
0808772  A A	1431472 1431472	L=637 T=48 I=115	BUS: RIZAR PB - SERIE F-K-L-N
0907528  A	639370 639370 550799 550806 0639370 1104334 112506 1517403	I=115 p=24 D=62 d=17	BUS: RIZAR PB - SERIE F-K-L-N
0807901  A A	1431710 1431710 1514274 489037	L=640 T=48 I=130	IRIZAR PB - 3 SERIE - K-S SERIE
0907362  A	1435944 1435944	I=130 D=85 d=19	
0807455  A A	489989 1796671 445599 489989	L=650 T=48 I=130	IRIZAR PB - 3 SERIE - K-S SERIE
0907362  A	1435944 1435944	I=130 D=85 d=19	

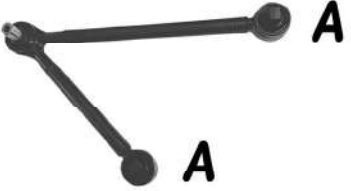



BARRE DI REAZIONE - TORQUE RODS

RIF. OCAP OCAP REF.	RIF. ORIG O.E. NUMBER	NOTE REMARKS	MODELLO / DESCRIZIONE MODEL / DESCRIPTION
0808773 	1324889 1324889	L=652 T=48 I=115	BUS: SERIE F-K-N
0907528 	639370 639370 550799 550806 0639370 1104334 112506 1517403	I=115 p=24 D=62 d=17	BUS: SERIE F-K-N
0808775 	0481959 0481959	L=670 T=48 I=130	IRIZAR PB - SERIE F-K-N
0907259 	1104335 1104335	I=130 p=30 D=70 d=19	IRIZAR PB - SERIE F-K-N
0807453 	463435 463435	L=750 T=38 I=100	SERIE 3
0907405 	639319 639319 550812	I=100 D=67 d=17	
0808777 	415853	L=827/601 T=48 I=130	SERIE 3
0907259 	1104335 1104335	I=130 p=30 D=70 d=19	SERIE 3
0809879 	489986 489986	L=902/703 T=48	SERIE 4: K94 - L 94 - N 94











BARRE DI REAZIONE - TORQUE RODS

RIF. OCAP OCAP REF.	RIF. ORIG O.E. NUMBER	NOTE REMARKS	MODELLO / DESCRIZIONE MODEL / DESCRIPTION
<p>0907362</p> <p>A </p>	<p>1435944 1435944</p>	<p>l=130 D=85 d=19</p>	



KIT DI SOSPENSIONE - SUSPENSION KITS

RIF. OCAP OCAP REF.	RIF. ORIG O.E. NUMBER	NOTE REMARKS	MODELLO / DESCRIZIONE MODEL / DESCRIPTION
0907528 	639370 639370 550799 550806 0639370 1104334 112506 1517403	l=115 p=24 D=62 d=17	IRIZAR PB
0907362 	1435944 1435944	l=130 D=85 d=19	IRIZAR PB - SERIE 4 K94 - L 94 - N 94
0907405 	639319 639319 550812	l=100 D=67 d=17	SERIE 3
0907259 	1104335 1104335	l=130 p=30 D=70 d=19	SERIE 3







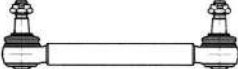
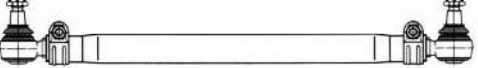

STABILIZZATORI - STABILIZERS

RIF. OCAP OCAP REF.	RIF. ORIG O.E. NUMBER	NOTE REMARKS	MODELLO / DESCRIZIONE MODEL / DESCRIPTION
0509886 	1766014 1766014 463245	L=100 T=31	SERIE K
0509889 	1766015 1766015 445626	L=130 T=31	SERIE K - SERIE 3
0508740 	488739 488739	L=145 T=30	SERIE 4 - IRIZAR PB
0589888 	1506924 1506924	L=150 T=30	SERIE K - SERIE IRIZAR PB - (DESTRO - RIGHT)
0599888 	1506925 1506925	L=150 T=30	SERIE K - SERIE IRIZAR PB - (SINISTRO - LEFT)
0588741 	488056 488056	L=160 T=26	SERIE 4 - K
0598741 	486590 486590	L=160 T=26	SERIE 4 - K
0507896 	416159 416159	L=210 T=28	BUS: SERIE 3
0509890 	1789082 1455327 1751418 1789082 1928859 483527	L=284 T=36	SERIE K - IRIZAR PB
0509913 	488738 488738	L=293 T=36	SERIE F-K-N - IRIZAR PB
0509392 	21477917 22287868 21477917 22287886 21412073	L=390 T=36	IRIZAR















KIT PERNO FUSO - KING PIN SET

RIF. OCAP OCAP REF.	RIF. ORIG O.E. NUMBER	NOTE REMARKS	MODELLO / DESCRIZIONE MODEL / DESCRIPTION
<p>0927452</p> 	<p>550732 550732 550713 550714</p>	<p>L=228 D=53,5/44,5</p>	<p>K 112 1984 > - BR 116 1980 ></p>
<p>0927453</p> 	<p>550730 550730 550729</p>	<p>L=215 D=44,5/55</p>	<p>K 113 1986 ></p>



BARRE ACCOPPIAMENTO - TIE RODS

RIF. OCAP OCAP REF.	RIF. ORIG O.E. NUMBER	NOTE REMARKS	MODELLO / DESCRIZIONE MODEL / DESCRIPTION
0507224 	3112050 3112050	L=300	B6 - B7 - B10
0507109   0186959 M=30x1,5 RHT  0196959 M=30x1,5 LHT	1626494 1626494	L=1592	B 56
0509900   0186959 M=30x1,5 RHT  0196959 M=30x1,5 LHT	8156123 8156123	L=1674 T=42	B 10 - B 12
0507719   0186960 M=30x1,5 RHT  0196960 M=30x1,5 LHT	1194390 1194390	L=1674	B9M - B10M - B12M











TIRANTI LONGITUDINALI - DRAG LINKS

RIF. OCAP OCAP REF.	RIF. ORIG O.E. NUMBER	NOTE REMARKS	MODELLO / DESCRIZIONE MODEL / DESCRIPTION
0509892 	3098294 85104265 85114167 3098294	L=495 T=40	B 12 - IRIZAR PB
0507223 	3112273 3112273	L=743	B 6 - B 7 - B 10
0507222  0186946  M=30x1,5 RHT	3112122 3112122	L=763	B 12
0508791 	9522701 9522701	L=770	B 12
0509882  0186960  M=30x1,5 RHT	1197339 1197339	L=1028 T=62	SERIE B10 - B12
0507692  0186960  M=30x1,5 RHT	1197338 1197338	L=1028	B 10 B - B 10 BLE - B 10 N - B 12
0507686  0187686  M=30x1,5 RHT	20745924 20490120 20745924 21308024 9519279	L=1028 T=60	8500-8700-9700-9900-IRIZAR PB-B10-B12
0509354  0187686  M=30x1,5 RHT	20490123 20490123	L=1030 T=62	
0509899  0186424  M=30x1,5 RHT	3039647 3039647	L=1041 T=42	B 6 B6R



TIRANTI LONGITUDINALI - DRAG LINKS

RIF. OCAP OCAP REF.	RIF. ORIG O.E. NUMBER	NOTE REMARKS	MODELLO / DESCRIZIONE MODEL / DESCRIPTION
0509355 	20739082 20739082	L=1243 T=42	
0509901   0186960 M=30x1,5 RHT	3116050 3116050	L=1822 T=50	B 10 B10M











TESTE STERZO - TIE RODS END

RIF. OCAP OCAP REF.	RIF. ORIG O.E. NUMBER	NOTE REMARKS	MODELLO / DESCRIZIONE MODEL / DESCRIPTION
0186595 	1518142 1518142	L=95 M=25x1,5 RHT	B 12
0196595 	1517448 1517448	L=95 M=24x1,5 LHT	B 12
0182259 	6313300535 6313300535	L=105 M=24x1,5 RHT	100 Autobus (631) D
0186946 	3090727 3090727 3110002 3988965 3090472	L=115 M=30x1,5 RHT	
0186424 	1697247 1697247 1695690 1696057 1517577	L=115 M=30x1,5RHT	
0186960 	1695776 1695776 1507826 1695585 1698557	L=120 M=30x1,5 RHT	B 9 M- B 10 M- B 12
0196960 	1698840 1698840 1131744 1698558 6869744	L=120 M=30x1,5 LHT	B 9 M- B 10 M- B 12
0186959 	1698846 1698846	L=120 M=30x1,5 RHT	B 12
0196959 	1698847 1698847	L=120 M=30x1,5 LHT	B 12
0187686 	3093647 3093647 21263821	L=140 M=30x1,5 RHT	8500-8700-9700-9900-IRIZAR PB-B10-B12
0286964 	1699401 1699401 1131742 1696901	L=168 M=52x1,5 RHT	B 7-B 7 F-B 7 R - B 9 M- B 12 - B 10 M-B 10 R - B 58-310 M











TESTE STERZO - TIE RODS END

RIF. OCAP OCAP REF.	RIF. ORIG O.E. NUMBER	NOTE REMARKS	MODELLO / DESCRIZIONE MODEL / DESCRIPTION
0296964 	1699400 1699400 1131741 1696900	L=168 M=52x1,5 LHT	B 7-B 7 F-B 7 R - B 9 M- B 12 - B 10 M-B 10 R - B 58-310 M
0288781 	85104266 85104266	L=206	B12 - B9 - IRIZAR PB





BARRE DI REAZIONE - TORQUE RODS

RIF. OCAP OCAP REF.	RIF. ORIG O.E. NUMBER	NOTE REMARKS	MODELLO / DESCRIZIONE MODEL / DESCRIPTION
0809362 A  B	1135429 1135429	L=510 T=48	BUS: B10-B12
0907222 A 	1598588 1598588	l=125 p=20 D=91 d=14	B10-B12
0907224 B 	1135080 1135080	D=91 d=52	B10-B12
0809363 A  A	24426046 24426046	L=510 T=48	B12
0909363 A 	3093467 3093467	l=130 p=24 D=75 d=17	B12-B9
0809364 A  B	9523794 9523794	L=535 T=46	8700 - B7
0907222 A 	1598588 1598588	l=125 p=20 D=91 d=14	B10-B12-8700 - B7
0907224 B 	1135080 1135080	D=91 d=52	B10-B12-8700 - B7
0809365 A  A	9523795 9523795	L=535 T=46	8700 - B7
0907222 A 	1598588 1598588	l=125 p=20 D=91 d=14	B10-B12-8700 - B7
0809368 	20816966 20816966	L=580 T=48	B12-B13-B7-B9







BARRE DI REAZIONE - TORQUE RODS

RIF. OCAP OCAP REF.	RIF. ORIG O.E. NUMBER	NOTE REMARKS	MODELLO / DESCRIZIONE MODEL / DESCRIPTION
0809372  A A	20510773 20510773	L=666 T=48	8700 - B9
0907528  A	271187 271187	l=115 p=24 D=62 d=17	8700 - B9
0809373  A B	1135427 1135427	L=666 T=48	8700 - B10 - B12
0907222  A	1598588 1598588	l=125 p=20 D=91 d=14	B10-B12-8700 - B7
0907224  B	1135080 1135080	D=91 d=52	B10-B12-8700 - B7
0809375  A A	1589817 1589817	L=666 T=48	B10-B12-B9
0907222  A	1598588 1598588	l=125 p=20 D=91 d=14	B10-B12-B9
0809376  A A	20837990 20837990	L=666 T=48	B12-B9
0909363  A	3093467 3093467	l=130 p=24 D=75 d=17	B12-B9
0809387  B B	24426048 24426048	L=760 T=48	BUS: B12-B13-B9

BARRE DI REAZIONE - TORQUE RODS

RIF. OCAP OCAP REF.	RIF. ORIG O.E. NUMBER	NOTE REMARKS	MODELLO / DESCRIZIONE MODEL / DESCRIPTION
0909363 A 	3093467 3093467	l=130 p=24 D=75 d=17	B12-B9
0809388 A 	1194631 1194631	L=773 T=48	B10-B12-B9
0909379 A 	1075255 1075255	p=96 D=138	B10-B12-B9
0907222 B 	1598588 1598588	l=125 p=20 D=91 d=14	B10-B12-B9







KIT DI SOSPENSIONE - SUSPENSION KITS

RIF. OCAP OCAP REF.	RIF. ORIG O.E. NUMBER	NOTE REMARKS	MODELLO / DESCRIZIONE MODEL / DESCRIPTION
0907297 	3093469 3093469	IK=38 D=65	B12
0907528 	271187 271187	l=115 p=24 D=62 d=17	8700 - B9
0907222 	1598588 1598588	l=125 p=20 D=91 d=14	B10-B12-8700 - B7
0907224 	1135080 1135080	D=91 d=52	B10-B12-8700 - B7
0909363 	3093467 3093467	l=130 p=24 D=75 d=17	B12-B9
0909379 	1075255 1075255	p=96 D=138	B10-B12-B9



SNODI SOSPENSIONI - SUSPENSION JOINTS

RIF. OCAP OCAP REF.	RIF. ORIG O.E. NUMBER	NOTE REMARKS	MODELLO / DESCRIZIONE MODEL / DESCRIPTION
<p>0408780</p> 	<p>20739867 20739867</p>		<p>B12 B12</p>

STABILIZZATORI - STABILIZERS

RIF. OCAP OCAP REF.	RIF. ORIG O.E. NUMBER	NOTE REMARKS	MODELLO / DESCRIZIONE MODEL / DESCRIPTION
0109903 	948372 948372	L=40 M=8x1 RHT	B 10 B10M
0508782 	70376892 70376892	L=150	8700 - B12 B12 - B9 - IRIZAR PB
0508783 	9959503 9959503	L=150	B12 B12
0508785 	24425411 24425411	L=160	
0509906 	3112282 3112282	L=220 T=31 M=24x1,5 RHT	B 9
0509904 	1196631 1196631	L=354	B10 - B12
0509392 	21477917 22287868 21477917 22287886 21412073		B 7 - B 9

TESTE COMANDO CAMBIO - GEAR BOX CONTROL BALL JOINTS

RIF. OCAP OCAP REF.	RIF. ORIG O.E. NUMBER	NOTE REMARKS	MODELLO / DESCRIZIONE MODEL / DESCRIPTION
0287229 	1696685 1696685	L=55 M=12x1,75 RH	B 6 - B 7 - B 10
0297229 	1696684 1696684	L=55 M=12x1,75 RH	B 6 - B 7 - B 10

KIT PERNO FUSO - KING PIN SET

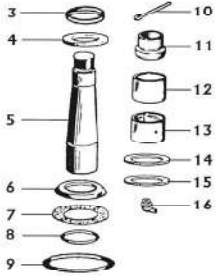
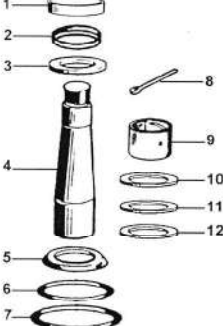
RIF. OCAP OCAP REF.	RIF. ORIG O.E. NUMBER	NOTE REMARKS	MODELLO / DESCRIZIONE MODEL / DESCRIPTION
0927456 	3090267 3090267 271141 270911 276015 276024 276030 276032	L=237 D=48	ASSALE/AXLE: 253270-253283-253295 - - B6 - B7F - B7FA 1983 > - B9M - B10M - B10MBR -B10R 1978 > - B12 - B57 - B58 - B59 1976 >
0927458 	3090266 3090266 271142 270912 276023 276031	L=251 D=50/38	ASSALE/AXLE: 253290 - - BUS: - B9M CH.20001 > - B10M - B10B - B10BLE - B10L - C10M - B12 - B12BR

COMPONENTI - COMPONENTS

RIF. OCAP OCAP REF.	RIF. ORIG O.E. NUMBER	NOTE REMARKS	MODELLO / DESCRIZIONE MODEL / DESCRIPTION
<p>1216349</p> 	<p>3028448 3028448</p>	<p>D=90</p>	<p>B10-B12</p>

O.E.	OCAP	PAG.	O.E.	OCAP	PAG.	O.E.	OCAP	PAG.
-	0182344	249	0000721608	0506642	245	0003304035	0287136	203, 369, 390
-	0182345	249	0000755676	0507986	396	0003304135	0297136	203, 369, 390
-	0182346	250	000192	0197125	327	0003305035	0180730	200, 366
-	0186167	88	000218	0507132	325	0003305635	0187342	201, 367
-	0187460	388	000221	0507134	325	0003305835	0186424	202, 367
-	0187854	250	0002680189	0187228	228	0003306735	0186595	200, 366
-	0187856	250	0002684689	0287229	228	0003306835	0196595	200, 366
-	0192345	249	0002684789	0297229	228	0003306935	0190729	204, 370
-	0196167	88	0002684889	0187228	228	0003307035	0180729	204, 370
-	0196547	204	0002685589	0287646	228	0003307135	0186613 35-37, 39,	201, 367
-	0197854	250	0002685989	0189997	228	0003307235	0196613	201, 367
-	0288003	124	0002686189	0297229	228	0003307335	0186424	202, 367
-	0401127-K	21	0002686289	0287229	228	0003307535	0186612	38, 201, 367
-	0402742	33, 65	0002686389	0287646	228	0003307635	0196612	201
-	0403877	48, 61	0003200028	0402159	31, 35, 227, 379	0003307735	0287136	203, 369, 390
-	0404260	41	0003200128	0402159	31, 35, 227, 379	0003307835	0297136	203, 369, 390
-	0407249	26	0003200132	0588936	380	0003308135	0186547	202, 367
-	0407250	27	0003200232	0598936	380	0003308535	0186595	200, 366
-	0600887	67	0003201232	0507433	359	0003308635	0196595	200, 366
-	0601406	69, 71	0003220223	0508970	229	0003308735	0186595	200, 366
-	0601412	69, 71	0003220323	0508968	229	0003308835	0196595	200, 366
-	0602230	60	0003220423	0508969	229	0003309335	0186613 35-37, 39,	201, 367
-	0602231	60	0003300035	0196424	202	0003309435	0196613	201, 367
-	0602741	32, 65	0003300075	0908978	374, 378	0003309535	0186613 35-37, 39,	201, 367
-	0603811	43, 45, 57	0003300080	0907882	371, 377	0003309635	0196613	201, 367
-	0604250	41	0003300107	0907217	375, 378	0003309735	0186612	38, 201, 367
-	0604334	73	0003300107	0907531	377	0003309835	0196612	38, 201, 367
-	0606927	26	0003300148	0196424	202, 367, 389	0003309935	0186612	38, 201, 367
-	0901169	13	0003300207	0907327	377	0003310017	0907671	221, 225
-	0901527	14	0003300235	0196595	200, 366	0003381610	0187560	36-40, 200
-	0901528	14	0003300248	0186424	202, 367	0003381810	0187342	201, 367
-	0902079	67	0003300335	0186595	200, 366	0003382129	0186613 35-37, 39,	201, 367
-	0902230	60	0003300410	0908988	375-376, 378	0003383410	0186424	202, 367
-	0902231	60	0003300511	0907927	224	0003383429	0186612	38, 201, 367
-	0907210	335	0003300611	0907259	372-374, 377	0003383529	0186612	38, 201, 367
-	0907484	391, 394	0003300635	0186595	200, 366	0003383629	0186613	367
-	0907485	392, 394	0003300707	0907528	372-373, 375, 378	0003384923	0188932	201
-	0907556	391, 394	0003300735	0196595	200, 366	0003384929	0287136	203, 369, 390
-	0907745	253, 258	0003300827	0188934	368	0003385029	0297136	203, 369, 390
-	0907746	253, 257	0003300835	0180729	204, 370	0003401151	0287753	251
-	0907747	253, 258	0003301035	0187560	36-40, 200	0003401152	0297753	251
-	0907748	253, 258	0003301107	0808750	371	0003401169	0186598	249, 398
-	0907757	91, 127, 129-130, 133, 135, 163-164, 171	0003301135	0187560	36-40, 200	0003401170	0196598	250
-	0927409	175	0003301135	0198931	201	0003401202	0297753	251
-	0927410	175	0003301235	0186612	38, 201, 367	0003401203	0287753	251
-	0927450	262, 403	0003301335	0196612	38, 201, 367	0003401206	0196599	250
-	1211481	32, 65	0003301411	0907635	221-223	0003401207	0186599	250
-	1211482	28	0003301435	0186613 35-37, 39,	201, 367	0003406212	0186424	249, 398
-	1215173	11, 19, 55	0003301535	0186613 35-37, 39,	201, 367	0003406213	0196424	249
-	1215174	11, 19, 55	0003301611	0907883	371, 377	0003406218	0196424	249
-	1215175	11, 19, 55	0003301635	0187560	36-40, 200	0003406236	0186598	249, 398
-	1215176	9, 16, 53	0003301935	0297136	390	0003406242	0186424	249, 398
-	1215177	9, 16, 53	0003302011	0907407	350, 354, 371, 377, 394	0003406242	0186613	248
-	1215503	41	0003302111	0907591	373, 377	0003406251	0186598	249, 398
-	1215504	41	0003302410	0186595	200, 366	0003406252	0186595	248
-	1215646	56	0003302511	0908989	377	0003406253	0186424	249, 398
-	1215647	56	0003302635	0180729	204, 370	0003406254	0186598	249, 398
-	1215671	70, 72	0003302635	0190729	204, 370	0003406260	0186598	249, 398
-	1215677	23	0003302735	0180729	204, 370	0003406261	0186598	249, 398
-	1215822	10, 18, 54	0003302835	0287136	203, 369	0003500105	0907584	216-217, 223
-	1215823	10, 18, 54	0003302935	0297136	203, 369, 390	0003500113	0907541	219, 225
-	1215870	56	0003303135	0186547	202, 367	0003500205	0907620	223
-	0000712758	245	0003303235	0186424	202, 367	0003500213	0907556 206-209, 211, 213, 216-220,	225
-			0003303335	0196613	201, 367	0003500305	0907556 206-209, 211, 213,	

O.E.	OCAP	PAG.	O.E.	OCAP	PAG.	O.E.	OCAP	PAG.
		216-220, 225	0004604505	0508954	192	0005861633	0907601	210-211, 223
0003500405	0907584	216-217, 223	0004604542	0180730	200	0005861733	0907602	210-211, 224
0003500413	0907330	207, 212, 218-219, 225	0004604548	0180730	366	0005861833	0907584	216-217, 223
0003500505	0907556	206-209, 211, 213, 216-220, 225	0004604648	0190731	35, 204	0005861933	0907584	216-217, 223
0003500506	0907259	372-374, 377	0004604848	0187971	204	000977	0197125	327
0003500613	0907304	206, 208-209, 212, 216, 219-220, 225	0004604905	0508962	198	000978	0187125	327
0003500905	0908992	378	0004604948	0287684	201	0009964845	0287361	200, 366
0003500906	0907362	377	0004605505	0507694	198	0009965045	0289998	228
0003501005	0907672	371, 377	0004605648	0187342	201, 367	0009965145	0299998	228
0003501013	0907531	212, 224	0004605748	0186551	203, 368	0009965245	0189995	228
0003501305	0907414	375, 378	0004605748	0186961	205	0009966645	0289999	228
0003501405	0908983	217-218, 226	0004605848	0196961	203	0009966745	0299999	228
0003501505	0907201	223	0004606005	0507971	186	0009966845	0189996	228
0003501513	0907906	371, 377	0004606048	0186551	203, 368	0013300035	0196612	38, 201
0003501805	0907304	206, 208-209, 212, 216, 219-220, 225	0004606048	0196961	203	0013300135	0186424	202, 367, 389
0003501905	0907623	220, 225	0004606305	0507971	186	0013300235	0186424	202, 367
0003502005	0907984	215, 222, 224	0004606548	0182261	30, 366	0013300335	0186547	202, 367
0003502105	0907622	215, 221, 225	0004606605	0507641	198	0013300435	0186547	202, 367
0003502205	0907609	223	0004606748	0287907	349, 370	0013300735	0180729	204, 370
0003502305	0907634	214, 224	0004606848	0186551	203, 368	0013300835	0190729	204, 370
0003502405	0907774	129, 131, 134-135, 166-167, 173, 215-216, 225	0004606848	0186961	205	0013300935	0180729	204, 370
0003502505	0907599	214-216, 223	0004606948	0196961	203	0013301035	0180729	204, 370
0003502605	0908990	225	0004607048	0186551	203, 368	0013301235	0187560	36-40, 200
0003502705	0907547	207, 213, 224	0004607048	0186961	205	0013301435	0187560	36-40, 200
0003502805	0907907	224	0004607048	0186961	205	0013301835	0186599	203
0003503105	0908991	225	0004607105	0506585	193	0013302135	0287136	203, 369, 390
0003503305	0907840	224	0004607148	0196961	203	0013302235	0297136	203, 369, 390
0003503605	0907908	213, 220-221, 225	0004607205	0506585	193	0013302635	0287136	203, 369, 390
0003503705	0907909	213, 220-221, 224	0004607248	0182260	30, 201, 366	0013302735	0297136	203, 369, 390
0003504405	0907634	214, 224	0004607548	0186961	205	0013302835	0182260	30, 201, 366
0003504505	0907609	223	0004607748	0187137	368	0013304835	0182260	30, 201, 366
0003504605	0907622	215, 221, 225	0004607848	0197137	368	0013308835	0196424	202, 367
0003504705	0907984	215, 222, 224	0004608348	0186424	202, 367	0014600005	0507633	182
0003504805	0907840	214, 224	0004608448	0197971	204	0014600105	0507633	182
000360098524	0807671	221	0004608505	0507977	199	0014600248	0186598	202, 368
0004600148	0187146	202, 369	0004608548	0180730	35, 200, 366	0014600305	0507594	189
0004600348	0186598	202, 368	0004608648	0190731	35, 204	0014600348	0196598	203, 368
0004600648	0196598	203, 368	0004608748	0190731	35, 204	0014600405	0507594	189
0004601005	0507970	189	0004608948	0186598	202, 368	0014600448	0186551	203, 368
0004601105	0507970	189	0004609205	0507629	192	0014600448	0186961	205
0004601248	0196598	203, 368	0004609305	0507629	192	0014600505	0508953	191
0004601748	0187467	203	0004609505	0507967	196	0014600548	0196961	203
0004602148	0180730	200, 366	0004609805	0507627	196	0014600648	0187971	204
0004602248	0186598	202, 368	0004609905	0507627	196	0014600705	0507968	194
0004602248	0190731	204	0004631129	0187342	367	0014600748	0197971	204
0004602648	0187146	202, 369	0004632329	0287466	388	0014600805	0507968	194
0004602705	0507695	190	0004632629	0287466	388	0014600848	0186598	202, 368
0004602748	0187146	202, 369	0004633229	0186595	200, 366	0014600948	0186598	202, 368
0004602848	0186598	202, 368	0004633429	0186424	202, 367	0014601105	0507961	186
0004602948	0186598	202, 368	0004633529	0186424	202, 367	0014601148	0186551	203, 368
0004603448	0196598	203, 368	0004634429	0287361	200, 366	0014601148	0186961	205
0004603548	0196598	203, 368	0004634629	0287684	201	0014601248	0186598	202, 368
0004604005	0508941	185	0005860132	0907638	210, 223	0014601305	0507911	198
0004604105	0507694	198	0005860135	0907584	216-217, 223	0014601348	0196961	203
0004604148	0180730	35, 200, 366	0005860632	0907602	210-211, 224	0014601405	0507911	198
0004604248	0190731	35, 204	0005860732	0907836	210, 224	0014601448	0196598	203, 368
0004604305	0508943	186	0005861035	0907621	223	0014601505	0507587	187
0004604348	0180730	200, 366	0005861135	0907304	206, 208-209, 212, 216, 219-220, 225	0014601648	0288930	200
0004604348	0187342	201, 367	0005861235	0907330	207, 212, 218-219, 225	0014601748	0186551	203, 368
0004604405	0507628	198	0005861433	0907556	206-209, 211, 213, 216-220, 225	0014601748	0186961	205
						0014602048	0187137	368
						0014602105	0507695	190
						0014602148	0187137	368
						0014602205	0507695	190
						0014602248	0186598	202, 368
						0014602348	0196598	203, 368

O.E.	OCAP	PAG.	O.E.	OCAP	PAG.	O.E.	OCAP	PAG.
0014602448	0186961	205	0024600148	0186598	202	0034608005	0509479	197
0014602505	0508950	190	0024600248	0196424	202	0034608605	0509470	199
0014602548	0196961	203	0024600348	0196598	203	0035603405	0507964	197
0014602905	0506582	189	0024600405	0507961	186	004204	0196598	327
0014602948	0187916	204	0024600505	0507911	198	004206	0186598	327
0014603005	0506582	189	0024600548	0187789	204	004728	0507129	325
0014603448	0186424	202, 367	0024600605	0507440	186	004729	0507130	325
0014603748	0196598	203, 368	0024600948	0287684	201	004908	0507128	325
0014603848	0187959	202	0024601005	0507977	199	004909	0507127	325
0014604148	0187789	204	0024601705	0507973	194	0067303	0296428	88
0014604205	0507829	196	0024604305	0507630	193	0067354	0907327	92-93, 95
0014604248	0187789	204	0024604405	0507630	193	0067389	0286428	88
0014604848	0187959	202	0024604505	0507789	195	0069600	0907487	92
0014604905	0507441	195	0024604605	0507789	195	0069867	0187146	87
0014605048	0187789	204	0024604705	0507631	193	0074607205	0506585	193
0014605105	0508959	196	0024604805	0507631	193	0080521	0807489	92
0014605148	0187959	202	0024604905	0507615	195	0083380029	0196612	38
0014605305	0507440	186	0024605005	0507615	195	0087932	0507924	79, 266, 325
0014605505	0507964	197	0024605105	0507912	194	0094006	0509933	79
0014605648	0187435	369	0024605205	0507912	194	0094016	0506431	80
0014605705	0507966	187	0024605305	0507584	196	0094029	0506429	81
0014606105	0508971	199	0024605405	0507584	196	0094037	0507492	83
0014606505	0507978	189	0024605905	0507965	197	0094038	0506430	82
0014606705	0506585	193	0024606005	0507965	197	0094044	0507945	84
0014606905	0507629	192	0024606105	0507962	197	0094053	0507494	84
0014606948	0287360	366	0024606205	0507962	197	0094613	0507799	83
0014607005	0507968	194	0024606405	0507632	191	0098726	0507495	83
0014607048	0287361	200, 366	0024607505	0507973	194	0100873	0927399	100
0014607105	0507967	196	0024607605	0507973	194	0110196	0196613	86
0014607305	0507587	187	0024607705	0507637	196	0110197	0186613	86
0014607405	0507441	195	0024607805	0507637	196	0117343	0506429	81
0014607448	0197146	369	0024608805	0509461	199	0118086	0927401	100
0014607548	0197146	369	0024608905	0509461	199	0122810	0186758	89
0014607648	0186551	203, 368	0024609205	0507974	197	0161376	0187146	87
0014607648	0186961	205	0024609305	0507974	197	0171215	0506431	80
0014607748	0186598	202	0024609605	0507614	189	0206137	0927398	100
0014607948	0196961	203	0024609705	0507614	189	0267743	0807501	91
0014608248	0188933	202	002763	0507129	325	0273203	0287503	86
0014608448	0187789	204	002765	0507126	325	0274878	0507945	84
0014608548	0187789	204	0034600705	0507963	195	0275962	0507800	77
0014608605	0508960	197	0034601805	0507642	194	0278665	0506816	269
0014608648	0187959	202	0034601905	0507642	194	0281007	1216314	101
0014608905	0508963	198	0034602905	0507977	199	0283784	0186598	272
0014608948	0187789	204	0034603105	0507961	186	0288281	0507934	77
0014609005	0508966	199	0034603205	0507911	198	0296110	0807507	92
0014609648	0186551	203, 368	0034603305	0507587	187	0301369	0506939	264
0014609705	0507804	190	0034603405	0507964	197	0306981	0506918	269
0014609748	0186424	202	0034603505	0507966	187	0310977	0507725	265
0014609805	0507632	191	0034603805	0507978	189	03109774	0507725	265
0014609905	0507632	191	0034604005	0507912	194	0310979	0296759	273
0014609948	0187959	202	0034604105	0507965	197	0310980	0286759	273
0014632229	0186424	202	0034604205	0507962	197	0311300	0196424	87, 328
0023123224	0506695	238	0034604405	0507973	194	0350270	0187230	286
0023123230	0506695	238	0034604505	0507974	197	0356310	0186960	303
0023123247	0506642	245	0034604605	0507887	195	0362413	0507799	83
0023123251	0807745	253	0034604705	0507963	195	0366351	1216312	101
0023123253	0807252	255	0034604805	0507630	193	0368541	0807509	93
0023123262 *	0187891	251	0034604905	0507631	193	0370875	0506919	268
0023123262	0506689	240	0034605005	0507789	195	0371586	1216313	101
0023123268	0507677	242	0034605105	0507637	196	0382774	0507188	266
0023123269	0507677	242	0034605605	0507615	195	0382780	0507727	266
0023123275	0807675	254	0034605705	0507614	189	0386930	0187228	99, 286
0023162046	0187228	260	0034605805	0507642	194	0388941	0507775	266
0023301335	0186612	38	0034605905	0507827	195	03889417	0507775	266
0023301435	0196612	201	0034606005	0507434	195	0388942	0507732	270

O.E.	OCAP	PAG.	O.E.	OCAP	PAG.	O.E.	OCAP	PAG.
0389867	0507728	267	0691709	0907359	91, 96	1094334	0507720	292
03898673	0507728	267	0693778	0907556	91, 95	1094466	0809909	308
0390784	0506913	268	0694298	0186424	86, 328	1094912	0507119	292
03907847	0506913	268	0694360	0186424	86, 328	11013547	0907259	392-394
0392418	0807513	92	0696225	0196598	87, 328	11015685	0196424	389
0395010	0186598	272	0696226	0186598	87, 328	11015686	0186424	389
0395350	0506939	264	0696226	0186758	89, 160, 272, 349, 389	11015863	0807354	391
03953502	0506939	264				1101843	0808776	279
0415400	0507730	405	0696320	0907525	93-95	11019632	0507468	384
043102	0507133	326	0696321	0907529	94, 96	11019635	0507469	385
043102.3	0507133	326	0696321	0907686	96	11019641	0507470	386
0466336	0507998	405	0697221	0187463	89	11019659	0186598	389
0466880	0509880	406	0698450	0186598	87, 328	11019661	0196598	389
0475087	0808774	277	0698586	0187530	89	11019664	0507472	386
0477889	0807451	409	0698609	0186424	86, 328	11019692	0507474	384
0481959	0808775	410	0698724	0907489	92, 94-95	11019859	0287361	388
0513757	0907359	91, 96	070550504	0907259	392-394	11019933	0187463	389
0548588	0927400	100	0817824	0287291	86	11019966	0187476	390
0554765	0506430	82	082192200	0196424	389	11020274	0507477	386
0586714	0186758	89, 160, 272, 349, 389	082192300	0186424	389	11020285	0507480	386
			082750900	0807354	391	11020291	0507481	384
0586753	0186424	86, 328	082750905	0907257	392, 394	11020292	0507482	384
0592106	0297229	99	082751027	0907623	220, 225, 394	1104334	0907528	274-276, 279, 282, 409-410, 412
0593883	0507939	79	082751110	0807357	391			
0606922	0296427	88, 328	082756320	0807464	392	1104335	0907259	276-279, 283, 410, 412
0606923	0286427	88, 328	0890991	0507798	79			
0607053	0196598	87, 328	0890992	0509934	79	1104336	0907529	282
0607073	0186758	89, 160, 272, 349, 389	093161371	0907586	126, 136, 335	11100492	0297752	251
			093163617	0907927	136	11100521	0287752	251
0607451	0186613	86	094038	0506430	82	1112023	0507729	268
0607452	0196613	86	100873	0927399	100	1112511	0506936	267
0607453	0186613	86	101347	0186422	75	11200265-0	0506588	233
0607981	0186598	87, 328	101348	0196422	75	11200360-0	0186592	235
0607998	0196424	87, 328	101694	0186598	75	11200361-0	0196592	235
0607999	0186424	86, 328	101695	0196598	75	11200454-0	0506590	234
0608000	0187146	87	10229	0186421	75	112506	0907528	274-276, 279, 282, 409-410, 412
0608122	0287519	90	10391031	0281725	21			
0608123	0297519	90	1047145	0281725	21	1127452	0507244	299
0608530	0186595	86	1055194	0401127	21	1130567	0507706	291
0609634	0186758	89, 160, 272, 349, 389	1071169	0507117	292	1131741	0296964	305, 419
			1071170	0508792	292	1131742	0286964	305, 418
0609643	0186758	89, 160, 272, 349, 389	1071315	0507122	298	1131744	0196960	304, 418
			1071344	0507118	296	1132493	0187228	322
0638680	0197523	90	1071674	0809366	306	113251	0186422	75
0639370	0907528	274-276, 279, 282, 409-410, 412	1075005	0507107	295	113252	0196422	75
			1075006	0507108	295	113253	0196598	75
0646373	0807797	91	1075153	0507112	297	113254	0186598	75
0649819	0807525	93	1075153	0507113	297	1134840	0507679	299
065472	0507131	325	1075179	1216353	324	1134955	1216355	324
065475	0507131	325	1075180	1216352	324	1135080	0907224	311, 317, 420-421, 423
065475.0	0507131	325	1075255	0909379	309, 311-313, 319, 422-423			
0655695	0807797	91				1135427	0809373	421
0655697	0807797	91	1075663	0507111	294	1135429	0809362	420
0656084	0297229	99	1075663	0507688	295	1135630	0507244	299
0658102	0807528	93	1075664	0507120	295	1138275	0283867	22, 24
0680374	0927402	100	1076639	0807762	311	1143319	0507930	79
0681511	0927404	100	1080690	0807221	307	1143322	0507943	81
0681621	0927402	100	1080786	0507114	294	1143324	0507946	84
0681706	0927403	100	1080787	0507106	294	1144018	0507930	79
0689747	0907531	93, 96	1080788	0507105	293	1149907	0186598	87
0689748	0907528	93, 95	1080792	0507708	288	11505036-0	0506591	234
0689749	0907259	92, 96	1082104	0807222	311	1152350	0186598	87
0691703	0907304	96	1083744	0507693	293	1152427	0507945	84
0691704	0907257	96	1088985	0507702	291	1164684	0509912	236
0691704	0907487	92	1094219	0509893	292	118086	0927401	100

O.E.	OCAP	PAG.	O.E.	OCAP	PAG.	O.E.	OCAP	PAG.
1190778	0186595	302	1270853	0507933	77	1320787080	0381141	7, 15, 51
1191900	0507946	84	1270854	0507934	77	1320855	0186424	86
11926	0186598	389	1271124	0907258	91	1320855	0187783	89
11927	0196598	389	1271126	0289923	86, 121, 158, 302	1321170	0509935	80
1193034	0507943	81	1277567	0509937	81	1321936	0907927	92, 95
1194390	0507719	415	1277568	0509936	81	1322663080	0391184	11, 19, 55
1194631	0809388	422	1278679	0187228	286	1322664080	0381184	11, 19, 55
1194824	0507680	292	1283203	0509945	82	1324483	0507737	267
1196631	0509904	425	1283211	0506435	81	1324483	0507782	267
1197338	0507692	416	1283212	0506434	80	1324889	0808773	410
1197339	0509882	405, 416	1284860	0807797	91	1326771	0807454	274
120110403	0187465	388	1286342	0507800	77	1326775	0807454	274
120110404	0287466	388	1286343	0506432	77	1326896	0186424	86
120164610	0287291	388	1291048	0509948	83	1329134	0196598	87, 328
1203.223.00	0197467	203	1291060	0506433	83	1331640080	0401446	8, 15, 52, 137
120322300	0197467	390	1294251	0807927	91	1331641080	0401451	8, 16, 52, 137
120322305	0187467	389	1295415	0507931	77	1331937080	0391451	9, 16, 53
120322809	0507468	384	1297572	0507942	76	1331938080	0391446	8, 15, 52
120322812	0507469	385	1300284	0507781	267	1331939080	0381451	8, 16, 52
120323000	0507470	386	1300473080	0401138	8, 15, 52, 137	1331940080	0381446	8, 15, 52
120324001	0186612	388	1300716080	0181602	9, 16, 53	1333754080	0391184	11, 19, 55
120324002	0196612	388	1300716080	0181602-K	9, 17, 53	1333755080	0381184	11, 19, 55
120324500	0507471	385	1300720080	0181602-K	9, 17, 53	1337366	0196758	272
120325000	0186598	389	1300720080	1215491	17	1337367	0186758	160, 272, 349, 389
120325100	0196424	389	1300721080	0181602-K	9, 17, 53	1337644	0507934	77
120325101	0186424	389	1302368080	0401137	7, 15, 51, 137	1338714	0196424	87, 328
120325200	0196598	389	1304569	0506919	268	1338769	0807771	274
120325500	0507472	386	1304569	0507735	268	1339464080	0391451	9, 16, 53
120325701	0186613	388	1304571	0506869	268	1339465080	0391446	8, 15, 52
120325702	0196613	388	1305012	0507737	267	1339466080	0381451	8, 16, 52
120325800	0507473	384	1305012	0507782	267	1339467080	0381446	8, 15, 52
120326000	0187146	389	1306003080	0280037	10, 18, 54	1341019080 *	0602637	9, 17, 53
120326100	0187342	388	1306332	0509949	84	1342026	0186424	86
120326200	0197342	388	1306716080	0281143	7, 14, 51, 123	1343262	0507999	266
120326400	0187571	389	1308600080	0391141	7, 15, 51	1343264	0509879	270
120328300	0507474	384	1308601080	0381141	7, 15, 51	1343266	0507767	266
1205248	0297796	88	1308643	0506916	270	1343278	0509884	271
1208073	0907508	92-93, 95	13086434	0506916	270	1343283	0507766	266
122162800	0287361	388	1308664080 *	0181322-K	11, 19, 55	1344684	0289927	87
122169000	0187463	389	1308759080	0391140	8, 16, 52	1345854080 *	0602637	9, 17, 53
122169100	0197463	389	1308760080	0381140	8, 16, 52	1346489	0507941	84
122169500	0187476	390	1310760	0199928	89	1348269	0509881	269
122350000	0507477	386	1311025080 *	0181322-K	11, 19, 55	1348271	0508753	269
122351400	0807478	391	1311048	0507932	83	1350658080 Z	0182638	10, 18, 54
122351500	0507479	386	1313056080 *	0181322-K	11, 19, 55	1351205	0509956	76
122351600	0507480	386	1313083080	0391184	11, 19, 55	1351714	0506435	81
122352700	0507481	384	1313084080	0381184	11, 19, 55	1351718	0507784	80
122352720	0507482	384	1313744	0196960	304	1351720	0507941	84
122352740	0507483	384	1315447	0196424	87, 328	1351730	0507939	79
1228114	0186613	86	1315530	0507940	84	1351731	0507940	84
1228115	0196598	87, 328	1315878	0287881	368	1351732	0507944	80
1229944	0186424	86, 328	1316735080	0391184	11, 19, 55	1351734	0506433	83
1235514	0287724	88	1316736080	0381184	11, 19, 55	1351737	0507932	83
1235515	0297724	88	1316872	0507737	267	1351741	0509931	79
1243618	0907997	95	1316872	0507782	267	1351745	0507939	79
1247956	0506435	81	1317238080	0391140	8, 16, 52	1352225080	0382638	10, 17, 54
1247957	0506434	80	1317239080	0381140	8, 16, 52	1352226080	0382639	10, 18, 54
1249088	0297229	99	1317240080	0391141	7, 15, 51	1352227080	0392638	10, 17, 54
1249129	0287229	99	1317241080	0381141	7, 15, 51	1352228080	0392639	10, 18, 54
1252284	0907296	96	1317389080	0391184	11, 19, 55	1353391	0507933	77
1257890	0186598	87, 328	1317390080	0381184	11, 19, 55	1353396	0506432	77
1257991	0507784	80	1319838	0196424	87, 328	1353400	0507931	77
1257992	0507944	80	1320755080	0391140	8, 16, 52	1353445	0807997	277
1261101	0807555	91	1320756080	0381140	8, 16, 52	1355449080 Z	0503520	10, 18, 54
1269973	0509950	84	1320786080	0391141	7, 15, 51	1356055	0506920	270

O.E.	OCAP	PAG.	O.E.	OCAP	PAG.	O.E.	OCAP	PAG.
1356055	0507766	266	1394446	0287906	121	1471654080	0601139	7, 14, 51
1357572080 Z	0182638	10, 18, 54	1394447	0289455	273	1471655080	0281143	7, 14, 51
1357674	0187723	273	1394884	0507726	266	1479120	0508756	406
1358792	0196598	272, 408	1395614	0507723	270	1479122	0507995	406
1358793	0186598	272, 408	1395993	0509946	83	1481465	0101724-K	22
1361155	0507942	76	1395994	0507947	82	1485758	0808764	275
1361157	0507931	77	1395995	0509947	83	1485760	0808770	276
1361413	0507723	270	1395999	0509985	85	1486756	0808762	274
1361650	0807501	91	1396000	0509961	84	1486758	0808760	274
1361651	0807489	92	1397866	0506939	264	1495683	0783867	23
1361652	0807930	94	1398368	0907926	95	1495684	0793867	23
1363858	0507935	80	1399019	0808769	276	1495685	0503254	23, 25
1363859	0507948	81	1399180	0807771	274	1497223	0508752	406
1363964	0507779	264	1399724	0287503	86	1497407080	0382734	12, 20, 56
1363984	0507779	264	140009680	0502735	12, 20, 56	1497408080	0392734	12, 20, 56
1367628	0507733	270	1401381380	0602733	11, 19, 55	1497552080	0602733	11, 19, 55
1367628	0507775	266	1401932	0509944	82	1498131	0907230	274-275, 282
1367641	0507734	270	1401937	0509941	82	1498132	0907846	168, 172
1367641	0507775	266	1401940	0507928	82	1499474	0808763	274
1368270	0807489	92	1401942	0197928	88	1499475	0808766	275
1369411	0506937	265	1401944	0189926	87	1499477	0808768	276
1369917	0507188	266	1405309	0509943	82	1499479	0808771	277
1369919	0506919	268	1405363	0509940	82	1500572	0808765	275
1369919	0507735	268	1405655	0507928	82	1501030	0506937	265
1371228	0793867	23	1406025	0507928	82	1505758	0196959	303
1371231	0783867	23	1406038	0509938	81	1505759	0186959	303
1373135	0186613	86	1406600	0509939	81	1505855	0507109	288
1373137	0196613	86	1407144	0507928	82	1505857	0506966	292
1373878	0509464	85	1407393	0509942	82	1506269	0186948	303
1375228	0287684	272	1407394	0196424	87, 328	1506924	0589888	413
1376728	0907931	96	1407963	0506167	76	1506925	0599888	413
1376729	0907932	97	1407963	0506168	76	1507260	0507771	269
1376730	0907297	96	1408040	0509390	84	1507822	0196959	303
1378435	0506939	264	1409918	0506937	265	1507823	0186959	303
1378436	0507779	264	1412254	0507124	289	1507826	0186960	303, 408, 418
1379071	0506920	270	1417351	0403867	22, 24	1509222	0807221	307
1379168	0506937	265	1426101	0509474	85	1514274	0807901	409
1380417	0507938	80	1427727	0507243	286	1515191600	0907634	167, 173
1383405	0187231	286	1428193	0508751	406	1515981	0907919	275, 283
1384025	0506920	270	1428349	0807454	274	1517279	0196613	302
1384027	0507731	269	1431471	0807451	409	1517403	0907528	274-276, 279, 282, 409-410, 412
1384896	0507243	286	1431472	0808772	409	1517439	0196613	302
1384897	0297229	286	1431710	0807901	409	1517440	0186613	302
1384898	0287229	286	1432723	0508746	405	1517444	0186613	302
1385251	0506937	265	1433448	0509960	84	1517448	0196595	302, 418
1385488	0507939	79	1433532	0508744	404	1517449	0186595	302
1385490	0507944	80	1433533	0508743	404	1517452	0186595	302
1385492	0506434	80	1435944	0907362	409, 411-412	1517577	0186424	303, 418
1385493	0507784	80	1438253	0783867	23	1517647	0196424	303
1385497	0506435	81	1438254	0793867	23	1518142	0186595	302, 418
1385498	0507932	83	1438475	0807452	409	1527234	0187241	322
1385499	0506433	83	1440028	0809434	280	1527989	0508758	265, 404
1385506	0507940	84	1444472	0909434	280, 283	1533026	0508749	405
1385513	0507941	84	1445656	0907925	95	1534756	0188994	272
1386618	0508759	270	1448062	0507935	80	1549071	0101724-K	22
1386753	0908778	282	1448063	0507948	81	15503811 *	0181322-K	11, 19, 55
1388436	0808767	275	1448064	0509464	85	15503811	0181602-K	9, 17, 53
1388958	0508757	264	1450364	0507996	405	1553239	0783867	23
1389190	0187843	89	1451118	0507937	80	1553250	0793867	23
1390932	0807489	92	1451119	0509932	79	1571862	0507716	288
1392640	0507936	85	1451122	0507936	85	1575690	0507720	292
1392962	0509987	98	1451129	0507938	80	1576092	0506969	296
1393383	0509416	271	1451917	0403867	22, 24	1576093	0507102	296
1394443	0287361	272	1455327	0509890	413	1576816	0507103	298
1394444	0287360	272	1464611	0807997	277			

O.E.	OCAP	PAG.	O.E.	OCAP	PAG.	O.E.	OCAP	PAG.
1576952	0807221	307	1626492	0506966	292	1705908	0196168	89
1576953	0807529	309	1626493	0506965	291	171419811	0280056	67
1577080	0506966	292	1626494	0507109	288, 415	1722582	0809434	280
1577081	0507245	291	16264947	0507109	288	1722753	0908763	274-277, 282
1581527	0807687	309	1626637	0507124	289	1723895	0506937	265
1584620	0506965	291	1626670	0507718	293	1723897	0187894	272, 408
1587489	0507103	298	16266702	0507718	293	1732635	0509879	270
1588017	0506966	292	1626671	0507895	299	1732972	0509957	76
1588018	0507245	291	1626672	0507680	292	1732973	0509438	77
1588263	0506965	291	1626749	0506968	294	1732980	0509955	76
1589817	0809375	311, 421	1626750	0507104	294	1733471	0509885	270
1590068	0809908	308	1626751	0506967	294	1734019	0507723	270
1592939	0507101	293	1626896	0807762	311	1734020	0506939	264
15929391	0507101	293	1626957	0807690	306	1737683	0506937	265
1592940	0507100	293	1626958	0807690	306	1738379	0187723	273
15929409	0507100	293	1628107	0909380	309, 311-313, 319	1738380	0196598	272, 408
1592959	0507114	294	1628635	0509891	296	1738381	0186598	272, 408
1598588	0907222	311-312, 317, 420-423	1628636	0507113	297	1747467	0509885	270
1599175	0507895	299	1629397	0508797	296	1751418	0509890	413
1602820	0507935	80	1629553	1249735	324	1755498	0507995	406
1602821	0507948	81	1629668	0807691	306	1755502	0507996	405
1603418	0199928	89	1629734	0807762	311	1755507	0508742	404
1603788	0289986	88	1631619	0101724-K	22	1759690	0507767	266
1603789	0186598	87	1668179	0187456	322	1759691	0507766	266
1603883	0187723	89	1668638	0187241	322	1763713	0403867	22, 24
1604247	0196168	89	1669010	0187456	322	1763714	0503254	23, 25
1604248	0186168	89	1672152	0187228	322	1763991	0603867	24
1605035	0807222	311	16750635	0903144	27	1766014	0509886	285, 413
1606200	0807221	307	1676776	0909447	97	1766015	0509889	413
1606274	0507109	288	1685552	0188994	89	1767328	0186598	272, 408
1606276	0507716	288	1689604	0186608	86	1768898	0506920	270
1606277	0506965	291	1689605	0196608	86	1769597	0507731	269
1606282	0507103	298	1695511	0196613	302	1770730	0808761	274
1606283	0506969	296	1695585	0186960	303, 408, 418	1785340	0187894	89
1606284	0507102	296	1695689	0196424	303	1788520	0509416	271
1606551	0807762	311	1695690	0186424	303, 418	1789082	0509890	413
1606551	0809377	311	1695776	0186960	303, 408, 418	1793876	0807930	94
1606552	0807544	307	1696057	0186424	303, 418	1796671	0807455	409
1606897	0509896	289	1696684	0297229	322, 426	1807596	0509469	77
1606980	0287684	302	1696685	0287229	322, 426	1817754	0403867	22, 24
1607079	0807687	309	1696900	0296964	305, 419	1828523	0509459	85
1607483	0287457	302	1696901	0286964	305, 418	1847311	0506920	270
1608151	0809369	307	1696919	0186612	302	1847312	0507731	269
1608953	0507106	294	1696920	0196612	302	1863130	0807452	409
1608954	0507105	293	1697246	0186948	303	1869413	0507999	266
1610074	0507104	294	1697247	0186424	303, 418	1877332	0783868	24
1610338	0506967	294	1698047	0186948	303	1877334	0793868	24
1610338	0508794	293	1698190	0196613	302	1895858	0507995	406
1611864	0507109	288	1698191	0186613	302	1895860	0507996	405
1611880	0507718	293	1698532	0186959	303	189716	0186598	327
1612254	0509896	289	1698533	0196959	303	189717	0196598	327
1612779	0507703	300	1698557	0186960	303, 408, 418	1897335	0506937	265
1612781	0507706	291	1698558	0196960	304, 418	1897667	0507771	269
1612857	0507704	300	1698839	0196424	303	1897669	0508754	406
1612858	0507705	300	1698840	0196960	304, 418	1897671	0508755	406
1613351	0507895	299	1698846	0186959	303, 418	1902942	0509459	85
1613562	0506968	294	1698847	0196959	303, 418	1902996	0196168	89
16170096	0807489	92	1699400	0296964	305, 419	1902997	0186168	89
1618048	0186598	87	1699401	0286964	305, 418	1903526	0783870	25
1620436	0807930	94	1700000	0507949	77	1903527	0793870	25
1620438	0807797	91	1700001	0509959	78	1903652	0280515	26, 121
1620497	0809371	309	1700912	0507928	82	1912757	0506920	270
1624093	0287457	302	1703472	0186168	89	1912758	0507731	269
1624605	1216354	324	1703473	0196168	89	1912759	0287684	272
			1705907	0186168	89	1923962	0196608	86

O.E.	OCAP	PAG.	O.E.	OCAP	PAG.	O.E.	OCAP	PAG.
1923963	0186608	86	20547286	0907919	319	21287062	0509449	320
1928859	0509890	413	20556488	0809382	310	21287063	0509451	321
1942147	0807997	277	20556490	0809386	313	21295227	0807762	311
1998190	0196613	302	20556491	0809385	313	21299034	0509894	290
2007274	0509884	271	20556492	0809379	309	21308024	0507686	416
2007275	0509881	269	20556493	0809384	312	213123268	0507253	241
2007278	0509879	270	20581086	0509914	289	213123269	0507253	241
2007279	0509885	270	20581089	0189914	304	21367010	0509437	290
20303061	0507112	297	20587731	0509359	289	21406952	0509895	295
20361568	0509356	288	20589061	0807914	312	21412073	0509392	413, 425
20367555	0508784	291	206137	0927398	100	21431678	0289456	305
20374698	0288779	302	20702095	0909994	306, 309, 319	21477917	0509392	413, 425
20374831	0508789	291	20709844	0507863	299	21543888	0509462	301
20375555	0509897	295	20710008	0199914	304	21560865	0509412	300
20375556	0509895	295	20713859	0509910	237	21560868	0509412	300
20375787	0508793	293	20727840	0509412	300	21560892	0509460	301
20376808	0509351	297	20727843	0508723	293	21560894	0509460	301
20382314	0809909	308	20727850	0509460	301	2161883	0506937	265
20390745	0508799	297	20739082	0509355	417	21698607	0509462	301
20392649	0807762	311	20739867	0408780	424	22159733	0509897	295
20392778	0509357	289	20741710	0907913	318	22159741	0509465	301
20393061	0507112	297	20742127	0186598	304	22159755	0509473	290
20393063	0507120	295	20745042	0196598	304	22159757	0509436	290
20393069	0507111	294	20745924	0507686	416	22159758	0509472	290
20393069	0507688	295	20751021	0927221	323	22159764	0509468	290
20393079	0509891	296	20816966	0809368	420	22159765	0509437	290
20393083	0507702	291	20818840	0509463	301	22163223	0509466	301
20393089	0509441	300	20818854	0509439	246, 300	22163637	0509911	289
20393091	0509898	300	20829503	0807762	311	22287868	0509392	413, 425
20393093	0509361	300	20830369	0507975	288	22287886	0509392	413, 425
20393097	0509896	289	20837990	0809376	421	22318841	0509450	320
20393186	0509897	295	20840820	0909389	319	22318844	0509452	321
20393187	0509895	295	20894438	0187723	304	22380814	0509475	301
20399543	0509894	290	20937674	0188994	304	22526504	0509462	301
20400907	0507715	299	20994419	0507221	320	22526506	0509475	301
20400909	0507116	299	21041	0507470	386	23341677	0509462	301
20400941	0507115	296	21051052	0808738	306	243664	0187230	286
20400942	0507802	296	21106930	0509897	295	24425411	0508785	425
20400944	0507118	296	21106952	0509895	295	24425658	0509441	300
20410053	0809378	314	21119053	0509449	320	24425660	0509898	300
20442111	0509441	300	21119056	0509449	320	24426046	0809363	420
20442113	0509898	300	21119064	0509915	320	24426048	0809387	421
20443059	1249734	324	21119067	0509449	320	2443499	0506881	109
20443061	0507918	320	2113903	0506937	265	2444423	0506860	114
20443061	0807918	306	21146253	0509451	321	2454629	0506851	112
20443062	0507221	320	21146255	0509451	321	2458534	0506814	113
20443063	0508787	320	21176251	0509451	321	24601005	0507977	199
20443065	0507918	320	21176253	0509451	321	2460515	0187157	137, 141
20443066	0507221	320	21176255	0509451	321	2461519	0506854	113
20444418	0507918	320	21182238	0509451	321	2463583	0187156	137, 141
20444418	0807918	306	21182239	0509451	321	2475843	0506794	110
20448089	0809443	256, 316	21192770	0509473	290	2476050	0506788	110
20453027	0509893	292	21196798	0809445	316	2476066	0506755	110
20453063	0509360	300	21197609	0509450	320	2478910	0506818	109
20477805	0807691	306	21209705	0509452	321	2506671	0506795	330
20477807	0508786	320	21248088	0507221	320	251407187A	0400889	68
20490120	0507686	416	2125090	0506937	265	251407187C	0404001	68
20490123	0509354	416	21260274	0509916	288	251407361	0400888	68
20491771	0809381	310	21260275	0509358	289	251411041C	1214127	68
20497798	0507224	288	21260286	0509896	289	251419803	0501501	67
20497800	0507222	292	21261985	0509468	290	251419803A	0501501	67
20502944	0809909	308	21263821	0187686	304, 418	251419811	0280056	67
20510773	0809372	421	21263974	0189896	304	251419831A	1211142	67
20513949	0509441	300	21286847	0509915	320	2519077	0506858	113
20513951	0509898	300	21287061	0509915	320	2636650	0509477	271

O.E.	OCAP	PAG.	O.E.	OCAP	PAG.	O.E.	OCAP	PAG.
270911	0927456	323, 427	2D0407361A	0401505	31, 66	3090728	0196946	303
270912	0927458	323, 427	2D0411051	0591514	32, 67	3092189	0189896	304
271141	0927456	323, 427	2D0411052	0581514	32, 67	3092452	0909909	308, 310, 317
271142	0927458	323, 427	2D0422803	0501503	31, 66	3092471	0196959	303
271187	0907528	307-308, 314, 318, 421, 423	2D0422803	0601504	31, 66	3093301203	0507652	199, 365
271188	0907257	318	2D0422811	0281503	31, 66	3093301403	0507652	199, 365
271188	0907487	308, 313, 318	2D0422831	1211400	31, 40, 66	3093301603	0507652	199, 365
273373	0907359	306, 310, 317	2D0498831	0901504	31, 40, 66	3093301703	0507652	199, 365
273375	0907534	318	2D0511329	0104151	32, 67	3093301803	0507652	199, 365
273706	0907533	309, 318	2E0407152M	0782742	33, 65	3093301903	0507652	199, 365
274019	0907359	306, 310, 317	300308	0507188	266	3093302003	0507652	199, 365
274056	0907529	309, 313, 317	30042	0196421	75	3093302103	0507652	199, 365
274068	0907304	308, 317	3004600205	0507140	362	309331303	0507652	199
274069	0907545	308, 315	3004600305	0507139	386	3093467	0909363	420-423
274070	0907296	311, 317	3004600305	0507140	362	3093469	0907297	318, 423
275988	0907405	317	3004600405	0507138	364, 386	3093544	0907913	318
276015	0927456	323, 427	3004600505	0507138	364, 386	3093630	0907763	256, 258
276023	0927458	323, 427	3004600605	0507139	363, 386	3093631	0907763	256, 258, 312, 317
276024	0927456	323, 427	3004600705	0507139	363, 386	3093647	0187686	304, 418
276030	0927456	323, 427	301369	0506939	264	3093714	0187783	304
276031	0927458	323, 427	3014600005	0507140	362	3094600305	0500730	35, 184
276032	0927456	323, 427	3014600105	0507140	362	3094602905	0500730	35, 184
276191	0907683	307, 317	3014600505	0507138	386	3094603005	0500730	35, 184
276192	0907529	309, 313, 317	301639	0506939	264	3094603105	0500730	35, 184
276192	0907686	168, 173, 307, 318	3023300035	0196424	202, 367, 389	3094603205	0500730	35, 184
278663	0506889	269	3023300135	0196424	202, 367, 389	3096213	0186424	123
278664	0506889	269	3023300235	0196424	202, 367, 389	3097228	0189896	304
278665	0506816	269	3023300303	0507654	360	3097999	0189360	304
278666	0506816	269	3023300335	0196424	202, 367, 389	3098294	0509892	416
283766	0507777	264	3023300603	0507654	360	3099128	0289923	86, 121, 158, 302
283768	0507776	264	3023301803	0507654	360	3099230	0507975	288
283783	0196598	272, 408	3024600305	0507667	363	3099529	0189896	304
283784	0186598	272, 408	3024600505	0507661	186, 362	3103300035	0188935	369
288281	0507934	77	3024600605	0507661	186, 362	3103300135	0198935	369
291395	0506846	267	3024603505	0507667	363	3103300635	0187342	201
291396	0506846	267	3024603605	0507667	363	3103301035	0187342	201
291398	0506914	267	3024603905	0507661	186, 362	3103301219	0927416	230
296110	0807507	92	3024604005	0507661	186, 362	3103301235	0187342	201
2966252	0186598	332	3024633429	0186424	202	3103301335	0180730	35, 200, 366
2966321	0186613	122	3028448	1216349	324, 428	310977	0507725	265
2966635	0186613	122	3028448	1216350	324	3109774	0507725	265
2966688	0186424	123	3028448	1216351	324	310979	0296759	273
2968454	0907257	129-130, 135	3039647	0509899	416	310980	0286759	273
2968454	0907487	136	305317	0507242	286	3110001	0196946	303
2969507	0196613	122	305319	0297229	286	3110002	0186946	303, 418
2969808	0186598	123, 332	305320	0287229	286	3110011	0196959	303
2969844	0907259	127, 136, 334-335, 337	3053300403	0507619	360	3112050	0507224	288, 415
2980129	0196424	123	3053300803	0507619	360	3112122	0507222	292, 416
2980323	0186424	123	3053301003	0507619	360	3112273	0507223	416
2980875	0187146	123	3054600305	0507139	363, 386	3112282	0509906	425
2980884	0907258	91, 127, 129-130, 133, 135, 335	3054600605	0507142	364	3116050	0509901	417
2981461	0187278	122	306913	0506913	268	311846	0507725	265
2983125	0907262	128-129, 135	306913	0507188	266	3124480	0507116	299
2984061	0196598	123	306981	0506918	269	31244809	0507116	299
2984511	0196424	123	307443	0407232	286	3124594	0507116	299
2992592	0902749	28	3090015	0907770	306, 315	3124625	0189965	322
2992593	0602749	28, 125	3090015	0907917	319	3124962	0507121	297
2D0407021	0791505	31, 67	3090266	0927458	323, 427	3127737	0507118	296
2D0407021B	0791505	31, 67	3090267	0927456	323, 427	3133173	0907406	308, 319
2D0407022	0781505	31, 67	3090291	0289923	86, 121, 158, 302	3134600005	0507606	362
2D0407022B	0781505	31, 67	3090452	0909909	308, 310, 317	3134600105	0507606	362
2D0407140	1215705	32, 67	3090472	0186946	303, 418	3163300203	0507786	178, 360
			3090712	0907762	256, 258, 312, 318	3163300503	0507786	178, 360
			3090727	0186946	303, 418	3163300603	0507786	178, 360
			3090727	0507112	297	3163300703	0507786	178, 360

O.E.	OCAP	PAG.	O.E.	OCAP	PAG.	O.E.	OCAP	PAG.
3164600605	0507625	185	352095	0391141	7, 15, 51	3573330101	0808979	375
3164600705	0507625	185	352096	0391140	8, 16, 52	3573330205	0807822	374
3164600805	0507625	185	3520N3	0391446	8, 15, 52	3573330405	0807594	372
3164600905	0507625	185	3520N4	0391451	9, 16, 53	3573330505	0888977	372
3164800806	0507625	185	3520R8	0392734	12, 20, 56	3573330605	0807542	373
3172829	0809907	313	3520S0	0392638	10, 17, 54	3573330705	0898977	372
3173500606	0807418	371	3520S1	0392639	10, 18, 54	3573330905	0807542	373
3173500706	0807417	374	3521.65	0381141	7, 15, 51	3573500306	0807882	371
3173613	0509905	320	3521.66	0381140	8, 16, 52	3574601005	0507141	364
3173914	0508788	320	3521.J3	0381446	8, 15, 52	3574601105	0507141	364
319359	0507725	265	3521.J4	0381451	8, 16, 52	3574601205	0507142	364
3193731	0288993	303	352165	0381141	7, 15, 51	3574601305	0507142	364
3223301011	0807419	375	352166	0381140	8, 16, 52	3574601405	0507645	364
325537	0196758	272	3521J3	0381446	8, 15, 52	3574601505	0507645	364
325615	0187838	272	3521J4	0381451	8, 16, 52	3574602005	0507685	364
3265974	0280037	10, 18, 54	3521N9	0382734	12, 20, 56	3574602205	0507438	364
3273300103	0507620	181	3521P1	0382638	10, 17, 54	3574602305	0507685	364
3273300303	0507620	181	3521P2	0382639	10, 18, 54	3574602405	0507422	364
3273300403	0507620	181	3523301603	0507655	181	3574602505	0507426	363
3273300803	0507620	181	3523301903	0507655	181	3574603105	0507422	364
3354600005	0507665	187	3523302003	0507655	181	3574603205	0507426	363
3433201032	0807602	210	3523302303	0507655	181	3574603505	0507431	365
3433201632	0807601	210	3523302403	0507655	181	3583300103	0507605	181
3433201632	0807602	210	3523500306	0807638	210	3583300503	0507605	181
3433201632	0807637	211	3524602105	0507662	185	3583300703	0507620	181
3433201732	0807601	210	3524602305	0507621	185	3593300011	0807417	374
3433201732	0807602	210	3524602405	0507621	185	3640.32	0401137	7, 15, 51
3433201732	0807637	211	3524602905	0507662	185	3640.33	0401138	8, 15, 52
3433201832	0807601	210	3524603005	0507663	186	3640.54	0401451	8, 16, 52
3433201832	0807602	210	3524603705	0507607	185	3640.55	0401446	8, 15, 52, 137
3433201832	0807637	211	3524604605	0507662	185	364032	0401137	7, 15, 51
3433300103	0507647	178	3524604705	0507663	186	364033	0401138	8, 15, 52
3433300303	0507647	178	3524605505	0507662	185	364054	0401451	8, 16, 52
3433300403	0507647	178	3524605805	0507663	186	364055	0401446	8, 15, 52, 137
3434600405	0507664	187	3524606605	0507607	185	364067	0402638	9, 17, 53
3434600805	0507664	187	3524606705	0507621	185	3643307411	0807417	374
3434601005	0507664	187	3524606805	0507621	185	36466106007	0507952	346, 387
3434601205	0507664	187	3524607105	0507607	185	36466106012	0507410	346
3434601405	0507664	187	352635	0506889	269	36466106033	0507952	346, 387
3434601505	0507664	187	352637	0506829	269	36466106040	0507410	346
3435788	0181785	143	352645	0196758	272	366757	0196959	303
3435860032	0907601	210-211, 223	3553300319	0927432	231, 382	370875	0506919	268
345124	0506888	268	3555860033	0927432	231, 382	370875	0507735	268
34602905	0507977	199	3563300003	0507600	359	371448	0507243	286
3463300019	0927437	231	3563300103	0507144	362	371451	0297229	286
3463300119	0927438	231	3563300211	0807414	375	371452	0287229	286
3463303903	0507437	179	3563301410	0898988	376	371453	0507242	286
3463303903	0507669	179	3563301510	0888988	375	3734600305	0507667	363
3463304903	0507437	179	3563331304	0807672	371	3734600505	0507143	364
3463304903	0507669	179	3564600205	0507438	364	3734600505	0507667	363
3463320106	0927409	230	3573300203	0507616	361	3734600605	0507661	186, 362
3464600005	0507665	187	3573300403	0507616	361	3734600705	0507143	364
3464600105	0507665	187	3573300503	0507616	361	3734600705	0507667	363
3464605005	0507665	187	3573300603	0507742	361	3734600905	0507661	186, 362
3465860033	0927437	231	3573300703	0507742	361	3734601005	0507143	364
3465860133	0927410	230	3573300803	0507644	360	3736028	0503870	23
3465860133	0927438	231	3573300903	0507644	360	3736028	0903870	23
350270	0187230	286	3573301103	0507619	360	3753500105	0807984	215
3503307035	0186424	202	3573301403	0507644	360	3753500205	0807774	215
3503307135	0196424	202	3573301503	0507619	360	3753500505	0807599	213
3503307203	0507658	180	3573301603	0507616	361	3754600005	0507887	195
3520.95	0391141	7, 15, 51	3573301911	0808978	374	3754600405	0507789	195
3520.96	0391140	8, 16, 52	3573303111	0807419	375	3754600605	0508958	196
3520.N3	0391446	8, 15, 52	3573303411	0807418	371	3754601505	0507911	198
3520.N4	0391451	9, 16, 53	3573330101	0807531	375	3754601605	0507587	187

O.E.	OCAP	PAG.	O.E.	OCAP	PAG.	O.E.	OCAP	PAG.
3754601705	0507973	194	3874604905	0506579	193	3986454	0507124	289
3812A4	0600918	11, 18, 55	3874605005	0506575	193	3987354	0509905	320
3812F0	0602733	11, 19, 55	388941	0507775	266	3987356	0509453	321
3813300303	0507605	181	388942	0507732	270	3988695	0507112	297
3813300503	0507605	181	3889425	0507732	270	3988695	0507113	297
3813300603	0507605	181	388943	0507780	264	3988697	0507112	297
3813300703	0507605	181	3893200732	0807826	208	3988697	0507113	297
381339	0506869	268	3893200832	0807827	213	3988698	0508798	297
3813500206	0807556	211	3895860033	0927436	231, 382	3988701	0507120	295
3813500306	0807603	212	389867	0507728	267	3988704	0507111	294
3813500606	0807585	206	389870	0507924	79, 266, 325	3988704	0507688	295
381770	0282637	9, 17, 53	390784	0506913	268	3988708	0509891	296
381773	0282733	11, 19, 55	3913300019	0927436	231, 382	3988710	0509891	296
381777	0292637	9, 17, 53	3913300603	0507610	178	3988711	0507124	289
3823300403	0507435	361	3913300803	0507610	178	3988764	0508795	294
382613	0187682	322	3913301003	0507610	178	3988767	0508796	294
382702	0507727	266	3913301203	0507610	178	3988965	0186946	303, 418
382745	0187241	322	3914600605	0508945	187	3988968	0196946	303
382774	0507188	266	3914600905	0507697	199	4000SF *	0602637	9, 17, 53
382780	0507727	266	3914601705	0507697	199	4000SG *	0602637	9, 17, 53
3833500006	0807556	211	3914601805	0507697	199	400622	0900489	7, 14, 51
3833500105	0807218	216	3915860033	0927436	231, 382	400624	0601139	7, 14, 51
3834600605	0506963	194	3933200132	0807586	209	40160-00QAB	0401522	43, 46, 58
3834600705	0507696	195	3933200232	0807828	218	40160-00QAD	0401494	43, 45, 57
3834600805	0506584	194	3933200332	0807825	206	401608374R	0401536	47, 59
3834601405	0506963	194	3933200632	0506575	193	4018036	0186603	105
3834601605	0506584	194	3933300003	0507658	180	4018037	0196603	105
3834602108	0507696	195	3933300203	0507658	180	401815	0900489	7, 14, 51
3834602305	0506963	194	3933300303	0507658	180	4018A3	0281143	7, 14, 51
3834602405	0506584	194	3933300403	0507658	180	4018A4	0601139	7, 14, 51
3834604405	0506963	194	3933468	0903870	23	4018A5	1211310	7, 14, 51
3834604505	0506584	194	3933505205	0807218	216	4018E0	0282323	7, 14, 51
3834606605	0507696	195	3933505305	0807218	216	4018H4	0281143	7, 14, 51
3834606705	0507696	195	3933505405	0807218	216	4025438	0286665	106
3853300203	0507793	181	3933505505	0807218	216	4028250	0186604	105, 123, 332
3853300503	0507657	180	395009	0196598	272, 408	4028251	0196604	105, 332
3853300603	0507657	180	395010	0186598	272, 408	4041494	0903870	23
3853300803	0507793	181	3951306	0807770	306	4042022	0783869	23
3853301103	0507657	180	3953200132	0807606	207	4042023	0793869	23
3853301303	0507218	181	3953200206	0807612	208	4042068	0503871	24
3853301403	0507657	180, 360	3953200332	0807608	212	4047091	0283867	22, 24
3853301503	0507657	180	3953201432	0807610	219	4054600005	0507617	187
3853301603	0507793	181	3953201532	0807607	218	4054600305	0507617	187
3853301803	0507793	181	395346	0507778	264	4054600605	0507617	187
3853302103	0507218	181	395347	0507778	264	405909	0280037	10, 18, 54
3853302203	0507218	181	395348	0507779	264	4059921	0993868	22
3853302403	0507218	181	395350	0506939	264	4059922	0983868	22
3853500006	0807642	206	3953500006	0807611	207	4059923	0693868	22
3853500106	0807608	212	3953500206	0807643	209	4059924	0683868	22
3853500206	0807603	212	3953500606	0807614	212	4064600105	0507976	197
3854600805	0508952	191	3953500706	0807617	209	406635	0900449	7, 15, 51
386930	0187228	99	3953500806	0807600	212	406683 *	1211477	12, 19, 56
3874600005	0506579	193	3953501006	0807829	218	406683	0902733	12, 20, 56
3874600405	0506575	193	3953501106	0807831	219	406686	0902637	9, 17, 53
3874600605	0506580	190	3953501206	0807831	219	409639	0807758	278
3874600705	0506962	191	3953501306	0807618	219	41002118	0281786	143
3874601405	0506962	191	395432	0506939	264	41002119	0291786	143
3874601505	0507671	191	3962343	0507124	289	41002770	0807211	132
3874603205	0506962	191	3962768	0507703	300	41003268	0807292	127
3874603305	0506962	191	3963260081	1216339	383	41005309	0507288	111
3874603505	0507671	191	3964603005	0508961	197	41005450	0506932	110
3874603605	0507671	191	3985570	0509896	289	41005451	0506932	110
3874604405	0506580	190	3986443	0807691	306	41005456	0506927	112
3874604505	0506580	190	3986450	0507124	289	41005460	0507288	111
3874604805	0506579	193	3986452	0509897	295	41005463	0506931	116, 330

O.E.	OCAP	PAG.	O.E.	OCAP	PAG.	O.E.	OCAP	PAG.
41005466	0506927	112	416524	0807761	276	42117267	0506955	108
41005469	0507287	114	416800	0807759	278	42118693	0506955	108
41005472	0506897	114	417290	0807738	277	42118694	0507314	119
41005475	0507293	116	4173761	0403869	22, 24	42118781	0506955	108
41005523	0186949	143	42000481	0807262	128	42125057	0807209	126
41006093	0507293	116	42000486	0807298	128	421573	0507764	270
41009661	0807358	127	42001325	0506855	115	42200700	0506928	114
41009665	0807211	132	42001326	0506855	115	42202358	0506828	116
41009961	0807225	126	42003432	0506847	110	42203459	0506828	116
41011006	0807295	128	42014656	0506794	110	42204473	0506893	115
41011476	0507287	114	42014657	0506794	110	42204475	0506928	114
41016958	0506897	114	42019074	0507170	330	42211146	0506928	114
41016960	0507287	114	42023778	0507347	114	42211148	0506928	114
41016961	0507287	114	42023779	0507347	114	4243300303	0507618	178
41016964	0506927	112	42026837	0506794	110	4243300503	0507618	178
41022092	0807296	131	42026840	0506794	110	4244600305	0507611	193
41028269	0507904	115	42026853	0506788	110	42480023	0196595	122
41028598	0807211	132	42034051	0807298	128	42480024	0186595	122
41028599	0807296	131	42034054	0807262	128	42483386	0186598	123, 332
41028600	0807211	132	42035418	0507301	115	42483520	0186424	123
41029665	0807211	132	42035419	0507301	115	42484886	0186613	122
41032608	0507366	108	42037032	0507302	109	42484887	0196613	122
41032826	0507207	119	42037033	0507302	109	42485638	0297229	143
4103300205	0507428	363	42037040	0506818	109	42485639	0287319	143
4103300303	0507425	359	42037041	0506818	109	42485718	0186424	123
4103300503	0507425	359	42037384	0506827	109	42487165	0186612	122
41033237	0507366	108	42037386	0506904	108	42487482	0187228	340
41033479	0807211	132	42037655	0506794	110	42488269	0186598	123, 332
41033731	0807226	126	42037657	0506794	110	42488722	0907259	127, 136, 334-335, 337
41034479	0807211	132	42039631	0507303	118	42488722	0907331	337
4103500906	0807412	372	42041107	0807579	128	42489395	0196598	123
41035950	0807211	132	42041327	0281786	143	42489573	0186598	332
41035951	0807358	127	42041328	0291786	143	42489594	0186598	123, 332
41036944	0506932	110	42042912	0181785	143	42491638	0186598	332
41042050	0807211	132	42042950	0506848	116	42491937	0186595	122
41042092	0807296	131	42043293	0506856	113	42491957	0196598	123
41042093	0807299	132	42043295	0507306	112	42493431	0907330	126, 128, 136
41042919	0506931	116, 330	42043908	0506856	113	42493781	0186424	123
41203863	0281786	143	42043909	0507306	112	42493782	0196424	123
41203864	0291786	143	42043910	0507306	112	42530316	0287320	121
4120734	0403869	22, 24	42043912	0506848	116	42530929	0907583	336-337
41210795	0607191	144	42044493	0506762	329	42532294	0287313	121
41215165	0507370	116	42064639	0506827	109	42532977	0607552	28, 125
41218021	0807363	126	42065332	0807295	128	4253300003	0507636	178
41218482	0181785	143	42071290	0287294	143	42533073	0287361	121
41218621	0807372	131	42072495	0607254	144	42533101	0287360	121
41226580	0507370	116	42078019	0507310	117	42533102	0287906	121, 158
412405	0507772	268	4207841	0506840	118	42534911	0287552	26, 28, 332
412406	0507758	405	42079850	0291786	143	42535445	0907339	334, 337
41272428	0809448	134	42079852	0291786	143	42535446	0907331	337
41272706 Z	0907774	129, 131, 135, 166-167, 173	42079853	0281786	143	42536819	0907362	337, 393-394
41272706	0807373	131	42086282	0807308	132	42537936	0186598	123, 332
41272706	0907774	134	42086458	0506855	115	42538047	0287320	121
41296730	0807374	129	42087841	0506840	118	42538048	0289923	86, 121, 158, 302
41296731	0807374	129	42087842	0506840	118	42538384	0188994	124
41298449	0507904	115	42087846	0507309	117	4254600105	0507612	197
4131788	1215678	23	42087848	0507310	117	4254600205	0507612	197
4140393	0783869	23	42088124	0507284	119	4254600305	0507612	197
4140394	0793869	23	42100262	0506818	109	4254600405	0507612	197
414531	0807760	279	42100263	0506818	109	42551289	0787250	140
415400	0507730	405	42100703	0506818	109	42551289	0797250	27
416159	0507896	413	42102058	0506755	110	42551290	0787250	27
4164518	0783869	23	42102633	0507312	109	42551290	0797250	140
4164522	0793869	23	42105474	0287313	121	42551296	0797249	26, 139
			42115532	0507314	119			

O.E.	OCAP	PAG.	O.E.	OCAP	PAG.	O.E.	OCAP	PAG.
42551297	0787249	26, 139	4500094	1215609	43, 45, 58	4664297	0186605	105, 332
42569562	0289426	124	4500095	1215610	43, 45, 58	4664340	0187166	332
42569563	0289425	124	4500198	0593812	44, 46, 58	4664341	0197166	333
42569566	0609422	125	4500199	0583812	44, 46, 58	4664343	0186653	105
4274600005	0507611	193	4500255	0401494	43, 45, 57	4664345	0186651	105
4274600105	0507611	193	4501260 Z	1211392	46, 57, 59	4664347	0296606	107
4274600305	0507611	193	4501260	0903811	46, 59	4664349	0286606	106
4274600405	0507611	193	4501261	0603811-K	45	4664351	0296610	107
4322906	0280037	10, 18, 54	4501262	0291495	43, 45, 57	4664353	0286610	107
432698	0506933	407	4501263	0281495	43, 45, 57	4664460	0286650	106
4336779	0280513	121	4510017	0286606	106	4664462	0286652	106
4339248	1215388	14	4510018	0296606	107	4664586	0186657	106
4372130	0783869	23	4510019	0186605	105	4665005	0186649	105
4372131	0793869	23	4510620	0186605	105	4665007	0186648	105
4373300003	0507636	178	4514235	0286610	107	4665009	0286647	106
4373300403	0507636	178	4514236	0296610	107	4665085	0506709	103
4374600005	0507612	197	4514245	0286650	106	4665209	0506710	103
4374600105	0507612	197	4519467	0503254	23, 25	4665422	0286658	107
4381927	0403869	22, 24	4520694	0506712	102	4665501	0506711	103
4388159	0400097	13, 137	4520697	0186657	106	4666933	0506723	104
4391813	0380405	13	4520698	0506753	102	4666954	0506720	104
4391814	0390405	13	4520744	0506984	104	4666991	0506750	104
4401910	0401523	46, 58	4523292	0196605	106	4666993	0506723	104
4404048	0381494	43, 45, 57	4533777	0286666	106	4667156	0506721	104
4408474 *	0604424	48-49, 61, 63	4536229	0286659	105	466801	0807554	277
4408474	0604424-K	47, 49, 61-62	4540774	0783869	23	4668206	0286658	107
4408476 *	1211589	48, 50, 63	4540775	0793869	23	4668258	0506971	104
4408476	0903807	48-49, 61, 63	4544893	0186653	105	4668368	0286659	105
4408511	0283875	47, 49, 61-62	4545422	0506987	104	4668402	0506984	104
4408904	0503878	49-50, 62-63	4546822	0507154	103	4668771	0507168	331
4408958	0793808	48, 61	4557357	0507167	330	4668880	0509880	406
4408959	0783808	48, 61	4562450	0186651	105	4668881	0506938	406
4417177	0394627	49, 62	4568702	0506977	102	4669091	0506712	102
4417178	0384627	49, 62	4573092	0507154	103	4669094	0506753	102
4418212	0391494	43, 45, 58	4574457	0506981	104	4670853	0507192	128
4418213	0381494	43, 45, 57	4579231	0186614	121	4672795	0506781	331
4418225	0394627	49, 62	4579232	0196614	121	468285	0196598	272, 408
4418226	0384627	49, 62	4580778	0186684	106	468286	0186598	272, 408
4419215	0391536	47, 59	4580782	0187152	106	4688941	0186608	122
4419216	0381536	47, 59	4582159	0286652	106	4688942	0196608	122
4419217 Z	1216016	47, 59	4588688	0506976	102	4688944	0187160	124
4419218 Z	1216017	47, 59	4603300435	0182260	366	4688946	0287159	124
4419219	0401536	47, 59	4603301235	0182260	30, 201, 366	4688948	0186599	123, 332
4419291	0501536	47, 59	4603301335	0182260	366	4688949	0196599	123
4419304	0501496	47, 59	4608505	0507977	199	4688951	0186656	124
4420096 Z	0601536	46, 59	4624032	0506720	104	4688952	0186655	124
4420096	0901536	46, 58	4624116	0506721	104	4692686	0506714	103
4420097	0291536	46, 58	4626261	0507192	128	4699246	0506716	118
4420098	0281536	46, 58	4626917	0506709	103	4699305	0506717	117
4421646	0384627	49, 62	463245	0509886	285, 413	4702125	0506413	331
4421647	0394627	49, 62	463435	0807453	410	470272	0507189	407
4422269	0393875	50, 63	465816	0807554	277	4704183	0506810	117
4422270 *	0403875	50, 63	4659860	0506774	331	4704239	0507169	330
4422270	0383875	50, 63	4661613	0186620	333	4711108	0506760	331
4431869	0404627	48, 62	4661614	0196620	333	4711109	0506760	331
4440885	0503872	24	466336	0507998	405	4714134	0807207	127
445599	0807455	409	4663787	0186603	105	4714134	0807209	126
445626	0509889	413	4663791	0196603	105	4715615	0506839	117
445631	0807773	279	4663972	0186604	105, 123	4716271	0807208	130
445632	0807773	279	4663974	0196604	105	4716557	0507169	330
445634	0807772	278	4664088	0287151	106	4716799	0807257	130
4463926	0807282	129	4664090	0287150	106	4719609	0807283	133
4500090	0401523	46, 58	4664092	0287151	106	4720262	0507284	119
4500092	0391494	43, 45, 58	4664292	0186605	105	4722108	0507161	117
4500093	0381494	43, 45, 57	4664295	0196605	106	4732041	0286610	107

O.E.	OCAP	PAG.	O.E.	OCAP	PAG.	O.E.	OCAP	PAG.
4732042	0296610	107	50 01 852 452	0187723	251	5000786902	0506695	238
4732546	0506720	104	50 01 858 763	0187723	251	5000787304	0506676	245
4732549	0506721	104	5000027957	0807551	254	5000787305	0506676	245
4733704	0506750	104	5000240688	0186598	249	5000787306	0506676	245
4733752	0506723	104	5000242159	0186424	249, 398	5000787472	0506680	242
4738069	0807210	335	5000242478	0196598	250	5000787496	0807252	255
4741171	0507165	142	5000242479	0186598	249	5000791330	0506677	245
4741956	0506811	331	5000242485	0186598	249	5000793641	0907264	262
4741957	0506811	331	5000246729	0401398	64	5000793828	0927446	262
4747690	0506840	118	5000246730	0401399	64	5000793849	0927444	261
4747960	0506840	118	5000246731	0400951	64	5000794318	0927447	262
4747961	0506840	118	5000246732	0400952	64	5000794319	0927445	261
475463	0508745	405	5000253852	0186598	249	5000794320	0927443	261
4765442	0506764	120	5000275496	0186598	249	5000802123	0907678	254, 257
4773359	0506820	118	5000288360	0186598	249, 398	5000803459	0297350	251
4793166	0506826	118	5000288361	0196598	250	5000803460	0287350	251
4802443	0186598	123, 332	5000288362	0286641	251	5000803464	0287752	251
4802444	0196598	123	5000288363	0296641	252	5000803465	0297752	251
4815933	0506915	118	5000288364	0287892	250	5000804824	0186598	249, 398
4822291	0596419	329	5000288365	0297892	250	5000807536	0187228	260
4826513	0586419	329	5000295214	0186424	249, 398	5000807553	0196595	248
4827082	0586419	329	5000295215	0196424	249	5000807554	0186595	248
482779	0507771	269	5000297580	0187900	251, 305	5000808458	0187146	250
4833820	0186424	123	5000297581	0197756	251	5000810038	0807551	254
4833821	0196424	123	5000297668	0287753	251	5000812483	0186424	249, 398
4833825	0186613	122	5000297669	0297753	251	5000814096	0196595	248
4833826	0196613	122	5000333285	0907362	337, 393-394	5000814097	0186595	248
4833827	0186424	123	5000336305	0907263	262	5000816456	0297892	250
4833828	0196424	123	5000350120	0506904	236	5000819349	0186598	249
4833829	0186598	123	5000352082	0506690	243	5000819365	0907749	253-254, 256-257
4833830	0196598	123	5000352083	0506690	243	5000819413	0907595	254-255, 257
4834037	0506820	118	5000393080	0506595	236	5000823947	0196613	248
4834041	0506826	118	5000393204	0506595	236	5000823987	0186424	249
4835068	0506553	109	5000395296	0507202	240	5000823987	0186613	248
483527	0509890	413	5000395435	0507202	240	5000823997	0196613	248
4838587	0596419	329	5000446681	0506699	236	5000869572	0807753	254
4844041	0506994	109	5000450713	0587990	259	5000869573	0807756	256
48510-F3900	0509411	234	5000450714	0597990	259	5000869619	0807673	399
48510F3900	0509411	234	5000453600	0508728	244	5000869761	0587992	402
48510-F3901	0509411	234	5000489779	0407219	401	5000869762	0597992	402
48510F3901	0509411	234	5000516214	0187228	260	5000869763	0507993	402
48510-LA21D	0509411	234	500053864	0289476	124	5000874577	0506642	245
48510LA21D	0509411	234	5000541224	0506904	236	5000874578	0506642	245
48520-00QAH	0291495	43, 45, 57	5000541230	0506690	243	5000932435	0506688	241
48520-00QAJ	0281495	43, 45, 57	5000559335	0186424	249, 398	5000932435	0506693	245, 397
4852000780R	0281536	46, 58	5000590236	0186598	249, 398	500098430	0506694	397
485206730R	0291536	46, 58	5000613598	0506939	238	5001000134	0297229	260
48521-00QAF	0603811	43, 45, 57	5000613837	0506697	236	5001014520	0907406	257
485212373R	0601536	46, 59	5000614223	0506595	236	5001823279	0907677	255, 258
485212373R	0901536	46, 58	5000640089	0807673	399	5001823280	0907676	255, 258
4854871	0506953	109	5000725267	0506676	245	5001825687	0186613	248
4854874	0506952	115	5000725268	0507674	245	5001829030	0507744	397
4855237	0807286	133	5000745719	0506677	245	5001830480	0288930	248
4862449	0586419	329	5000748784	0506642	245	5001831473	0186424	249, 398
4862451	0586419	329	5000748868	0506642	245	5001831481	0186599	250
4865483	0807227	334	5000750976	0807252	255	5001831526	0907678	254, 257
486590	0598741	413	5000761670	0506692	397	5001832579	0196599	250
488056	0588741	413	5000761671	0507678	397	5001832580	0186599	250
488738	0509913	413	5000761673	0507989	396	5001832581	0196598	250
488739	0508740	413	5000783574	0807252	255	5001832582	0186424	249, 398
489037	0807901	409	5000783889	0506642	245	5001834533	0196424	249
489986	0809879	410	5000785429	0506751	242	5001836297	0196598	250
489987	0807554	277	5000786379	0597992	402	5001836298	0186598	249, 398
489989	0807455	409	5000786527	0506692	397	5001836801	0180730	248
4941233	0907359	306, 310, 317	5000786768	0507744	397	5001842337 *	0907739	255, 258

O.E.	OCAP	PAG.	O.E.	OCAP	PAG.	O.E.	OCAP	PAG.
5001842337	0907219	254-255, 258	500379802	0797249	139	5010145584	0507849	238
5001842823	0907259	254, 257, 399-400	500383975	0587871	28, 142	5010151409	0587992	402
5001844136	0186595	248	500383976	0597871	28, 142	5010151410	0597992	402
5001847026	0907845	353-354, 393-394, 399-400	500397738	0507369	117	5010151411	0507993	402
5001847436	0196595	248	500559335	0186613	248	5010151528	0507678	397
5001849879	0287361	248	500559336	0196613	248	5010151529	0506692	397
5001849880	0287360	248	5006172093	0808747	399	5010163161	0506686	244
5001850530	0807252	255	5006305888	0809921	335	5010163162	0506686	244
5001850550	0196424	249	5006305890	0809925	334	5010163163	0506686	244
5001850588	0907362	337, 393-394	5006305892	0809924	334	5010174785	0506694	397
5001852263	0196424	249	5006305917	1216307	341	5010174787	0506688	241
5001852452	0187723	251	5006306002	0589922	339	5010174787	0506693	245, 397
5001855163	0507677	242	5006306003	0599922	339	5010190148	0507986	396
5001858756	0196595	248	5006306531	0858055	339	5010199642	0507888	339, 402
5001858763	0187723	251	5010005937	0807752	253	5010207724	0507678	397
5001858773	0186598	249, 398	5010013397	0807756	256	5010207725	0506692	397
5001858774	0196598	250	5010013398	0807753	254	5010207726	0807753	254
5001860123	0186595	248	5010014345	0907252	254-255, 257	5010207727	0807756	256
5001860300	0907362	337, 393-394	5010037411	0508724	243	5010207728	0507989	396
5001860359	0506695	238	5010037418	0506686	244	5010207771	0807749	253
5001860769	0196595	248	5010037602	0506686	244	5010216608	0508734	237
5001860769	0197884	248	5010037603	0506686	244	5010224898	0506595	236
5001860770	0187884	248	5010039426	0508727	244	5010224899	0506699	236
5001866165	0187903	250	5010060764	0506679	241	5010229242	0506687	244
5001867774	0187903	250	5010064641	0807252	255	5010229243	0508730	244
5001868363	0508736	237	5010064715	0507755	242	5010238594	0597991	259
5001868374	0508721	241	5010092170	0506677	245	5010239340	0506678	246
5001868383	0509412	246	5010092191	0506677	245	5010239386	0506678	246
5001868385	0509460	246	5010094838	0807252	255	5010239387	0506691	246
500307556	0506950	108	5010094839	0807676	255	5010245591	0187228	260
500308895	0507367	115, 330	5010094840	0807219	255	5010253255	0597991	259
500309296	0187364	124	5010094941	0807252	255	5010253256	0587991	259
500310933	0280517	137, 141	5010097562	0506904	236	5010268035	0807678	254
500311471	0506413	331	5010098467	0507849	238	5010291903	0507865	237
500311473	0506413	331	50101030452	0506642	245	5010294287	0506681	241
500317413	0903144	27	5010104286	0507989	396	5010294288	0506684	242
500324282	0507859	113	5010104287	0508996	397	5010294289	0506685	242
500333284	0907407	135, 350, 354, 394	5010104289	0506692	397	5010294320	0508995	240
500334486	0787250	140	5010104365	0907749	253-254, 256-257	5010294502	0506682	242
500334487	0797250	140	5010129530	0287229	260	5010294720	0507854	242
500334713	0407249	138-139, 141	5010130344	0506688	241	5010305365	0509463	247
500334714	0407249	138-139, 141	5010130382	0507755	242	5010305367	0507863	244
500334716	0407250	138, 140-141	5010130383	0507740	241	5010308082	0506754	237
500334716	0787250	27, 140	5010130393	0506683	243	5010308083	0508735	237
500334716	0797250	140	5010130446	0506686	244	5010308214	0508733	236
500334717	0407250	138, 140-141	5010130447	0506686	244	5010308215	0507987	237
500334717	0797250	27, 140	5010130451	0507673	245	5010347099	0807750	399
500336085	0507367	115, 330	5010130453	0506642	245	5010347403	0808739	399
500336364	0507893	142	5010130456	0506686	244	5010347549	0508737	329, 396
500337201	0286616	26, 141	5010130483	0506680	242	5010383097	0507985	243
500339201	0903144	27	5010130710	0507765	246	5010383203	0508722	241
500340451	0807299	132	5010130739	0506678	246	5010383410	0508999	240
500340452	0807292	127	5010130740	0506691	246	5010383529	0507988	244
500344887	0407249	138-139, 141	5010130783	0508997	240	5010389262	0807674	254
500344887	0797249	139	5010138060	0506642	245	5010393047	0907362	337, 393-394
500344888	0407249	138-139, 141	5010138446	0506642	245	5010393672	0407219	401
500344888	0787249	139	5010138691	0506642	245	5010439021	0507858	238
500345518	1216308	341	5010144543	0187228	260	5010439022	0507856	238
500362533	0507852	119, 331	5010144549	0506676	245	5010439023	0507865	237
500363545	0507853	119, 330	5010144551	0506677	245	5010439631	0507849	238
500379801	0407249	138-139, 141	5010144552	0506676	245	5010467915	0807219	255
500379801	0797249	26, 139	5010144554	0507674	245	5010488051	0508720	240
500379802	0407249	138-139, 141	5010144556	0506677	245	5010488052	0506687	244
500379802	0787249	26, 139	5010144557	0506677	245	5010488084	0509439	246
			5010145077	0506695	238	5010488096	0508731	246

O.E.	OCAP	PAG.	O.E.	OCAP	PAG.	O.E.	OCAP	PAG.
5010488097	0507988	244	54501-00QAE	0391494	43, 45, 58	6013305235	0190727	34, 38, 200
5010488146	0507220	244	545019956R	0393875	50, 63	6013305335	0180727	34, 38, 200
5010488164	0507861	243	545601173R	1216017	47, 59	6013325306	0927412	230
5010488165	0507862	243	54570-00QAA	1215609	43, 45, 58	6013743	0506795	330
5010488167	0507863	244	546180004R	0501536	47, 59	6014300535	0501347	35
5010488464	0507884	240	54618-00QAA	0583812	44, 46, 58	6014600005	0500730	35, 184
5010488639	0509439	246	54618-00QAB	0593812	44, 46, 58	6014600105	0500730	35, 184
5010488759	0509439	246	548588	0927400	100	6014600205	0500730	35, 184
5010556210	0409919	338	550257	0927454	287	6014600305	0500730	35, 184
5010557243	0506679	241	550284	0927455	287	6014600505	0502257	35, 184
5010557341	0509439	246	550713	0927452	287, 414	6014600605	0502257	35, 184
5010557423	0508725	243	550714	0927452	287, 414	6014600705	0502257	35, 184
5010566048	0508732	236	550729	0927453	287, 414	6014600805	0502257	35, 184
5010566049	0507864	236	550730	0927453	287, 414	6014600905	0502257	35, 184
5010566058	0507987	237	550732	0927452	287, 414	6014601005	0502257	35, 184
5010566059	0507855	238	550799	0907528	274-276, 279, 282, 409-410, 412	6014601105	0502257	35, 184
5010566062	0507865	237				6014601205	0502257	35, 184
5010566063	0507858	238	550800	0907591	274, 278-279, 282	6014601305	0502257	35, 184
5010566064	0507856	238	550806	0907528	274-276, 279, 282, 409-410, 412	6014601505	0502257	35, 184
5010630255	0509463	247				6015865033	0927412	230
5010630434	0509435	238	550807	0907508	277, 282	6023300003	0502253	34
5010630812	0509460	246	5508072	0907508	277, 282	6023300035	0182254	34
5010630813	0509460	246	550808	0907997	277, 283	6023300103	0502253	34
5010630820	0509412	246	5508080	0907997	277, 283	6023300135	0192254	34
5010630821	0509412	246	550812	0907405	283, 410, 412	6023300303	0502253	34
5010630822	0508723	241	551100019R	0501496	47, 59	6023300403	0502253	34
5010630980	0508998	240	5516017400	0506690	243	6023300903	0502254	34
5010832582	0186598	249, 398	5516017831	0506690	243	6023301003	0502254	34
5010832583	0196598	250	554765	0506430	82	6023305303	0502254	34
504001436	0907230	135	574274	0196598	332	6023305403	0502254	34
504034521	0507866	119	579342	0186424	332	6023305435	0192254	34
504039506 *	0903144	140	579343	0196424	332	6023305535	0182254	34
504039506	0903144	27	5801208436	0409919	338	6023305735	0192254	34
504039506	1215953	27, 140	5801282537	0507365	116	6023305835	0182254	34
504049893	0507368	115	5801282538	0507365	116	6025370231 Z	0903811	46, 59
504092613	0507574	142	5801378064	0407894	28, 141	6025370231	1211392	46, 57, 59
504092614	0507552	142	5801564274	0909422	136, 139	6027074	0187228	322
504126384	0509918	329	5801564276	0909422	136, 139	606922	0296427	88, 328
504144266	0509421	111	5801564281	0909422	136, 139	606923	0286427	88, 328
504201479	0409919	338	5801564293 *	0409422	139, 141	608122	0287519	90
504212584	0407893	141	5801564293	0709422	139	608123	0297519	90
504212586	0407893	28, 141	5801564316 *	0409423	139, 141	6083200028	0402159	31, 35, 227, 379
50705629	0402638	9, 17, 53	5801564316	0709423	139	6083200128	0402159	31, 35, 227, 379
5081N9 Z	0182638	10, 18, 54	5801692437	0509421	111	6083300303	0502252	33
508735 *	0181322-K	11, 19, 55	5801891027	0509918	329	6083300403	0502255	34
508735	0181322	11, 19, 55	5801893542	0589922	339	6083305535	0192254	34
508756	0502735	12, 20, 56	5801893544	0599922	339	6083305735	0192254	34
525443	0506430	82	581528	0807687	309	6083330027	0182252	34
542150011	0395072	29	5829067053	0502255	34	6083380110	0192252	34
542150012	0385072	29	586753	0186424	86, 328	6084600105	0502256	34
542180020	0858054	29	589333	0287229	99	6113300019	0927411	230
542180023	0595068	29	6.851.488.000	0187342	367	6133300003	0507600	359
542180024	0585068	29	6.851.490.000	0197467	203, 369	6133300011	0807414	375
542410018	0405069	29	6.851.491.000	0187467	369	6133300103	0507144	362
542410025	0405069	29	6000025546 Z	0903811	46, 59	6150970	0101724-K	22
5430119888	0507741	240	6001547607	1211392	46, 57, 59	6150970	0181724	22
5430122944	0507741	240	6003300111	0807417	374	6150971	0101724-K	22
54423-00QAA	1215610	43, 45, 58	60103171	0506613	108	6150971	0191724	22
54500-00QAC	0381494	43, 45, 57	6013201389	0502744	33, 66	61590824	0506746	119
54500-00QAD	0381494	43, 45, 57	6013210350	1215817	33, 66	61590910	0506741	118
54500-00QAE	0381494	43, 45, 57	6013300019	0927412	230	61591070	0187158	122
545006069R *	0403875	50, 63	6013300435	0180727	34, 38	61591070	0507163	119
545006069R	0383875	50, 63	6013300535	0190727	34, 38, 200	61593332	0506743	116
54501-00QAC	0391494	43, 45, 58	6013300635	0180727	34, 38, 200	61595371	0506745	118
54501-00QAD	0391494	43, 45, 58	6013300735	0190727	34, 38, 200	61595957	0187158	122

O.E.	OCAP	PAG.	O.E.	OCAP	PAG.	O.E.	OCAP	PAG.
61595957	0507163	119	6253302503	0507591	180	6313300535	0182259	30, 418
61595960	0506746	119	6253303203	0507437	179	6313300603	0502259	30, 359
61600701	1211073	21	6253303203	0507669	179	6313300703	0502260	30
6173300203	0507795	180	6254601405	0507700	199	6313380310	0182261	30
6173300303	0507795	180	6254602505	0507640	192	6313380410	0192258	30
6174600005	0507626	192	6254604005	0507700	199	6313380510	0182260	366
6174600105	0507825	191	6254604205	0507694	198	6314600705	0502261	30
6174600205	0507626	192	6254605005	0507628	198	6323200232	0507433	359
6174600305	0507825	191	6254607805	0507694	198	6323200532	0507433	359
6174602005	0507592	190	6254609605	0507700	199	6323500306	0807416	374
6174602405	0507592	190	6254609805	0507700	199	634300120	0287752	251
6174602805	0507626	192	6264600005	0507427	365	634300130	0297752	251
6174602905	0507825	191	6273300103	0507421	359	6343260016	0598937	380
6174603405	0507592	190	6273300203	0507423	359	6343260116	0588937	380
6174603505	0507666	192	6273300303	0507429	359	6343260216	0598938	381
6174603605	0507666	192	6273500006	0807413	372	6343260316	0588938	381
6193500206	0807604	220	6273500106	0807413	372	6344600505	0507424	359
6194601205	0507804	190	6273500106	0807416	374	6383230268	0591907	41
6194602505	0506578	190	6273500206	0808973	371	6383230368	0581907	41
6194602705	0507804	190	6283200089	0597982	380	6383230468	0594163	41
6194602905	0506578	190	6283200189	0597983	380	6383230568	0584163	41
6194603105	0507804	190	6283200289	0587982	380	6383260116	0504160	41
6194605205	0506578	190	6283200389	0587983	380	6383300010	0791906	40
6194605305	0507804	190	6283201089	0597980	380	6383300110	0781906	40
619687	0186960	303	6283201189	0587980	380	6383330027	0401906	40
6203300003	0507593	182	6283201389	0587981	380	6384600048	0281904	40, 366
6203300503	0507593	182	6283201389	0597981	380	6384600048	0284249	41
6203300603	0507593	182	6283201489	0507433	359	6384600205	0501904	40
620350006	0807587	211	6283300003	0507435	361	6384600255	0601905	40
6203500106	0807587	211	6283300103	0507435	361	638680	0197523	278-279, 284
6204600005	0506575	193	6283300503	0508946	359	638861	0907531	278-279, 282
6204600105	0507805	194	6283330003	0807416	374	638862	0907259	276-279, 283
6204600505	0508951	190	6283330005	0807413	372	638869	0187759	278, 284
6204602005	0506575	193	6283330005	0807416	374	638870	0907761	276, 282
6204602105	0507805	194	6283330205	0807591	373	638938	0907773	279, 282
6204602405	0507670	196	6283330305	0807592	373	639287	0907259	276-279, 283
6204602605	0507670	196	6283330405	0807593	372	639288	0907773	279, 282
6204602805	0506575	193	6283331005	0807413	372	639299	0907759	278, 282
6204602905	0507590	191	6283331005	0807416	374	639319	0907405	283, 410, 412
6204603005	0507590	191	6283331105	0808974	371	6393200089	0594262	42
6204603705	0506575	193	6283331805	0807413	372	6393200189	0584262	42
6204603805	0507805	194	6283331805	0807416	374	6393300410	0794260	42
6204603905	0507805	194	6284600205	0507432	365	6393300510	0784260	42
6204604005	0507670	196	6284600305	0507430	363	6393330214	1215704	42
6204604105	0507670	196	6284601105	0507432	365	639340	0907623	220, 225
6224600205	0507698	187	6284601205	0507430	363	639361	0197751	278, 281
6224600305	0507698	187	6284601905	0508942	362	639362	0187772	278, 281
6224600405	0508948	188	6284602005	0508940	359	639370	0907528	274-276, 279, 282, 409-410, 412
6224600905	0507698	187	6293200189	0507433	359	6394600048	0294249	41
6224601005	0507698	187	6293380010	0188994	369	6394600055	0604250-K	41
6243500006	0807611	207	6293500006	0807411	374	6394600348	0284249	41
6243500106	0807616	208	6293500105	0807411	374	6394600548	0284249	41
6243500206	0807829	218	6293500106	0807412	372	6443500305	0808748	374
6243500306	0807613	219	6293500506	0807590	372	6474600005	0506962	191
6243500406	0807830	219	6293500606	0807590	372	6474600105	0506962	191
6243500506	0807618	219	6293501106	0807411	374	6474600205	0507671	191
6244600348	0287313	200	6293501206	0807412	372	6474600305	0507671	191
6253300119	0927440	231	6293502806	0807412	372	6517356	1215878	21
6253300219	0927441	231	6293520005	0807420	373	6517364	0281725	21
6253300903	0507910	179	6313200028	0402159	31, 35, 227, 379	6523500306	0807585	206
6253301203	0507910	179	6313200128	0402159	227, 379	6533500005	0807218	216
6253301503	0507591	180	6313200228	0402159	31, 35, 227, 379	6533500006	0807642	206
6253301603	0507591	180	6313300303	0502258	30	6533500105	0807218	216
6253302003	0508967	179	6313300435	0192260	30	6533500106	0807585	206
6253302403	0507591	180	6313300503	0502260	30			

O.E.	OCAP	PAG.	O.E.	OCAP	PAG.	O.E.	OCAP	PAG.
6533500205	0807619	216	6684601705	0507656	37, 39, 185	6763300303	0507792	178, 360
6533500305	0808983	217	6684601905	0507656	37, 39, 185	6763300403	0507790	179, 360
6533500405	0808984	217	6684602105	0507960	36, 38, 184	6763300503	0507792	178
6533500606	0808972	206	6684602205	0507960	36, 38, 184	6763300603	0507790	179, 360
653500006	0807586	209	6684602305	0507826	36, 38, 184	6763300703	0507790	179, 360
653503506	0807616	208	6684602405	0507826	36, 38, 184	6763300803	0507792	178, 360
6543500005	0807867	217	6687191	0281725	21	6763300903	0507790	179, 360
6543500105	0807867	217	6693300403	0507653	38	6763301003	0507792	178, 360
6543500305	0807867	217	6693300503	0507653	38	6763301103	0507788	179
6543500406	0808976	220	6703300003	0507653	38, 180	6763301203	0507788	179
6553500006	0807586	209	6703300103	0507653	38, 180	6764600105	0506577	188, 363
6553500305	0807218	216	6703300119	0927419	230	6764600205	0507701	188
6553500306	0807587	211	6703300203	0507653	38, 180, 360	6764600605	0506577	188, 363
656085	0287229	99	6703300219	0927420	231	6764600705	0507701	188
6563500005	0807619	216	6703300303	0507653	38, 180, 360	6764601105	0506577	188, 363
6583500005	0807218	216	6703300403	0507653	180	6764601205	0507701	188
6583500006	0807586	209	6703300503	0507653	180	6764601505	0506577	188, 363
6583500105	0807619	216	6704600805	0507830	36	6764601605	0507701	188
6583500205	0807619	216	6704600905	0507898	37, 185, 362	6764601905	0507639	188
6583500206	0807586	209	6704601205	0507830	36	6764602105	0507639	188
6593500106	0807643	209	6704601605	0507830	36	6764603105	0507794	188
6593500124	0807605	208	6704601805	0507898	37, 185, 362	6771112	0507707	299
6593500406	0807617	209	6704602005	0507830	36	6771120	0507715	299
6593500427	0807615	208	6704602205	0507898	37, 185, 362	67711200	0507715	299
6593500906	0807831	219	6704602605	0507659	35, 184, 362	6773300303	0506586	179
6593501006	0807618	219	6704602705	0507659	35, 184, 362	6773300403	0506586	179
6593501106	0807611	207	6704602805	0507624	36, 184, 362	6777705	0807770	306
6593501206	0807616	208	6704602905	0507624	36, 184, 362	6777855	0507116	299
6593501306	0807829	218	6713300003	0507619	360	6790473	0507717	295
6593501406	0807613	219	6713330005	0807822	374	6790474	0507681	295
6593501506	0807830	219	6713330105	0807594	372	6790572	0507115	296
6593501606	0807618	219	6714600005	0507422	364	67905729	0507115	296
6593502206	0807604	220	6714600105	0507426	363	6790607	0507802	296
6593502406	0807643	209	6714600205	0507422	364	67906073	0507802	296
6593502706	0807617	209	6714600305	0507426	363	6790766	0507802	296
6593503206	0807831	219	67303	0296428	88	6791948	0507116	299
6593503306	0807618	219	673300503	0507792	360	6797979	0807770	306
6593503406	0807611	207	6734600205	0506583	186	6799189	0507121	297
6593503506	0807616	208	6734600305	0507828	186	67991893	0507121	297
6593503606	0807829	218	6734600405	0506583	186	6799190	0509902	298
6593503706	0807613	219	6734600505	0507828	186	680374	0927402	100
6593503806	0807830	219	6734600605	0506583	186	681511	0927404	100
6593503906	0807618	219	6734600705	0507828	186	681621	0927402	100
6593504506	0807604	220	6734600805	0506583	186	681706	0927403	100
6608818	1215877	21	6734600905	0507828	186	6851475000	0186598	368
6608830	0782751	21	67389	0286428	88	6851476000	0196598	368
6608832	0792751	21	6744600405	0508947	188	6851478000	0187146	369
6643307211	0807417	374	6753300019	0927420	231	6851481000	0196598	368
6653307411	0807417	374	6753300119	0927419	230	6851484000	0186598	368
6673300303	0501499	37	6754601005	0506576	188, 363	6851485000	0196598	368
6673300403	0501499	37	6754601205	0506581	187, 363	6851486000	0187146	369
6673300503	0501499	37	6754601305	0508944	186	6851486000	0197146	369
6673300603	0501499	37, 180	6754601405	0507787	188	6851488000	0197146	369
6674600705	0507831	37	6754601605	0506576	188, 363	6851516000	0186424	367
6674601005	0507831	37	6754601805	0506581	187, 363	6851516000	0196424	367
6674601505	0507905	39	6754602005	0507787	188	6851523000	0197146	369
6674601605	0507608	39, 185	6754602205	0506576	188, 363	6851529000	0287881	368
6674601705	0507905	39	6754602405	0506581	187, 363	68515290000	0287881	368
6674601805	0507608	39, 185	6754602605	0507787	188	6851531000	0186598	368
6683300019	0927416	230	6754602805	0506576	188, 363	6851532000	0197146	369
6684600505	0507660	37, 39, 185	6754603005	0506581	187, 363	6851533000	0187146	369
6684600705	0507660	37, 39, 185	6754603205	0507787	188	6852195	0507769	298
6684600905	0507660	37, 39, 185	6754603305	0506581	187	6852196	0507768	298
6684601105	0507660	37, 39, 185	6763300103	0507788	179	6852197	0507710	298
6684601505	0507656	37, 39	6763300203	0507790	179, 360	6853511	0507709	288

O.E.	OCAP	PAG.	O.E.	OCAP	PAG.	O.E.	OCAP	PAG.
6853913	0187228	322	7166384	0506542	108	7701049282	0293875	47, 49, 61-62
6862225	0507708	288	7167757	0186608	122	7701049283	0283875	47, 49, 61-62
6866174	0507713	291	71737047	0391184	11, 19, 55	7701461667	0402235	61
6866175	0507714	291	71737048	0381184	11, 19, 55	7701461770	0180947	60
6869744	0196960	304, 418	7403193731	0288993	249	7701462427	0282240	57
6869950	1211165	21	7420390836	1249735	263	7701462692	0402241	57
68699511	0600081	21	7420399543	0509894	290	7701462693	0402242	57
6876948	0507712	296	7420448089	0809443	256, 316	7701462987	0502231	60
6882111	0186960	303	7420547286	0907919	256-257, 310	7701463035	0502230	60
6882112	0196960	304	7420581086	0509914	289	7701470361	1211392	46, 57, 59
6883300003	0507653	38	7420702095	0909994	253, 258	7701470362	0603811-K	57
6883300103	0507653	38	7420713859	0509910	237	7701470363	0291495	43, 45, 57
6884001	0196959	303	7420741703	0807913	256, 310	7701470364	0281495	43, 45, 57
6889509	0907359	306, 310, 317	7420741710	0907913	256-257, 310	7701473333	0604424-K	47, 49, 61-62
691709	0907359	306, 310, 317	7420761145	0508726	243	7701473334 *	1211589	48, 50, 63
696321	0907686	96	7420800194	0509374	259	7701473334	0903807	48-49, 61, 63
698609	0186424	86, 328	7420829503	0807762	256	7701477385	0404627	48, 62
6994601648	0186442	204	7420840815	0907763	256, 258	77362278	0282323	7, 14, 51
6994602405	0507694	198	7420850454	0509433	259	77362279	0283815	18
6994603705	0507700	199	7420937674	0188994	251	77364009	0282637	9, 17, 53
6994603905	0507700	199	7421051052	0808738	253	77364253	0292637	9, 17, 53
6994604005	0507700	199	7421192770	0509473	239	77364254	0902637	9, 17, 53
6C113A052BB	0783867	23	7421295227	0807762	256	7820249212	0606927	125
6C113A053BB	0793867	23	7421431678	0289456	252	7981909	0187228	340
6K13312	0289929	90	7421560838	0509471	247	7984276	0196612	122
6K13313	0299929	90	7421560848	0509467	247	7D0407140	1215663	70, 72
701407077A	1215660	69, 72	7421560865	0509412	246	7D0407140A	1215663	70, 72
701407087	1215659	68	7421560892	0509460	246	7D0407183	1215661	69, 72
701407140B	1215663	70, 72	7421698605	0509475	247	7D0407361	0401425	71
701407140C	1215663	70, 72	7421698607	0509462	246	7D0411045	1214109	70, 72
701407183C	1215661	69, 72	7422159755	0509473	239	7D0411049	0501443	69, 72
701407187A	0401409	69, 71	7422159764	0509468	239	7D1411041	1214276	70, 72
701407187B	0401409	69, 71	7422163226	0509412	246	7H0407151E	0392723	73
701407361B	0401410	69, 71	7422163231	0509466	247	7H0407151F	0392723	73
701411041	1214105	70, 72	7422163636	0509440	238	7H0407151G	0392723	73
701411041D	1214270	70, 72	7422163637	0509911	237	7H0407152E	0382723	73
701411049	0501443	69, 72	7422380814	0509475	247	7H0407152F	0382723	73
701411049B	0503864	70, 72	7422526504	0509462	246	7H0407152G	0382723	73
701419803C	0591405	68	7485114029	0287291	248	7H0407182A	1215872	74
701419803D	0591407	69	7485114932	0507755	242	7H0407183	1215873	73
701419803E	0591411	70	7485114938	0507985	243	7H0407361	0404336	73
701419804C	0581405	68	7567284	0400096	13, 137	7H0419803D	0594333	73
701419804D	0581407	68-69	7695185	0380565	14	7H0419803E	0594333	73
701419804E	0581411	70	7695186	0390565	14	7H0419804D	0584333	72
701419804F	0581413	71	7695190	0380406	13	7H0419804E	0584333	72
701419811A	0291405	68	7695191	0390406	14	7H0422817A	0294333	73
701419811B	0291407	69	7700302122	1215609	43, 45, 58	7H0422817B	0294333	73
701419811C	0291411	71	7700302123	1215610	43, 45, 58	7H0422817C	0294333	73
701419811E	0291413	71	7700302165	0593812	44, 46, 58	7H0422817D	0294333	73
701419812	0281405	68	7700307343	0583812	44, 46, 58	7H0422818A	0284333	73
701419812A	0281407	69	7700309070	0593812	44, 46, 58	7H0422818B	0284333	73
701419812B	0281411	71	7700309071	0583812	44, 46, 58	7H0422818C	0284333	73
701419812D	0281413	71	7700309189	0391494	43, 45, 58	7H0422818D	0284333	73
701501131	1215662	70, 72	7700309190	0381494	43, 45, 57	7H0422831	1211430	73
702419803A	0591406	68	7700312851	0401522	43, 46, 58	7H5411317	0504337	74
702419803B	0591407	69	7700312852	0401494	43, 45, 57	7H5411317A	0504337	74
702419803C	0591412	70	7700680852	1211128	60	7H8407361	0404335	73
702419803D	0591413	71	7700706007	1211123	60	7H8407361A	0404335	73
702419804A	0581406	68	7700774566	1211267	60	8.226.318.000B	0807415	373
702419804B	0581407	68-69	7701002911	0187146	250	8.226.323.000B	0807415	373
702419804C	0581412	70	7701011267	0907216	257	80003406	0506893	115
70371217	0908778	317	7701011412	0186598	249, 398	80003408	0506893	115
70376892	0508782	425	7701013272	0181401	63	80003410	0507321	114
7136367	0507155	104	7701013276	0191401	64	8073569	0809907	313
7166166	0506904	108	7701016946	0186424	249, 398	8074268	0809367	306

O.E.	OCAP	PAG.	O.E.	OCAP	PAG.	O.E.	OCAP	PAG.
81.43270.6065	0907406	168, 172	81432206114	0807822	352	81432206258	0807832	351, 393
81.44204.0008	0927406	357	81432206123	0807409	351	81432206260	0807817	169
81.44205.6009	0927406	175, 357	81432206125	0807409	351	81432206264	0807832	351, 393
81.44205.6013	0927408	175, 357	81432206127	0807409	351	81432206267	0807407	163
81.44205.6016	0927742	175	81432206129	0807559	163	81432206268	0807894	163
81.95301.6288	0187723	161	81432206132	0907258	91, 127, 129-130, 133, 135, 163-164, 167, 171, 335	81432206270	0809446	170
8122752	0186598	332				81432206271	0809420	170
8122754	0186424	123				81432206272	0807407	163
8122755	0196424	123	81432206134	0807915	352	81432206275	0807832	351, 393
8123326	0196608	86	81432206137	0807559	163	81432206276	0807823	351, 393
8123394	0196613	122	81432206140	0807824	164	81432206278	0807832	351, 393
8131582	0506931	116, 330	81432206143	0807822	352	81432206279	0807832	351, 393
8132373	0507683	299	81432206144	0807408	351	81432206282	0809420	170
8132397	0506931	116, 330	81432206145	0807808	350, 392	81432206283	0807817	169
8135446	0506897	114	81432206147	0807818	169	81432206284	0807817	169
8135492	0507287	114	81432206151	0807823	351, 393	81432206285	0909992	170, 173
8136061	0506927	112	81432206160	0807808	350	81432206304	0807407	163
8137026	0807211	132	81432206161	0807821	162, 350, 392	81432206305	0807407	163
8137027	0807358	127	81432206162	0807808	350	81432206314	0809420	170
8137594	0507860	110	81432206164	0807806	350	81432206322	0907820	162, 173
8138182	0506932	110	81432206165	0807806	350	81432206327	0809420	170
814304	0186601	105	81432206166	0807806	350	81432206341	0807820	162
814305	0196601	105	81432206173	0807822	352	81432206342	0807820	162
81432206010	0807214	162	81432206174	0807807	167	81432206369	0907362	393-394
81432206012	0807214	162	81432206177 *	0907816	350, 354, 391, 395	81432206382	0807407	163
81432206013	0807214	162	81432206177	0807816	350, 391	81432206396	0807408	351, 392
81432206020	0807214	162	81432206179	0807816	350	81432206396	0907259	392-394
81432206025	0807812	353	81432206183	0807823	351, 393	81432206401	0807407	163
81432206035	0807214	162	81432206185	0807822	352	81432206409	0807408	351, 392
81432206040	0807214	162	81432206187	0807410	351	81432206409	0907259	392-394
81432206041	0807214	162	81432206189	0807408	351, 392	81432209092	0807811	163
81432206042	0807814	353	81432206189	0907259	392-394	81432209129	0807559	163
81432206052	0807214	162	81432206190	0807821	162, 350, 392	81432209140	0807824	164
81432206055	0907259	162-164, 171, 350-354	81432206196	0807906	164	81432209236	0807407	163
81432206056	0807214	162	81432206202	0907405	162, 172, 307	81432209267	0807407	163
81432206067	0807811	163	81432206203	0907359	352	81432209272	0807407	163
81432206068	0807811	163	81432206204	0907409	351-352, 354	81432306014	0807559	163
81432206070	0807833	164	81432206208	0807808	350	81432306018	0807214	162
81432206071	0807833	164	81432206209	0807808	350	81432306028	0807214	162
81432206072	0807833	164	81432206210	0807408	351	81432306030	0807559	163
81432206073	0907259	162-164, 171, 350-354	81432206211	0807408	351	81432306031	0807809	164
81432206082	0807818	169	81432206213	0807801	168	81432306037	0807216	162
81432206083	0807818	169	81432206213	0907339	168, 172	81432306038	0807810	169
81432206084	0807818	169	81432206215	0807806	350, 392	81432306039	0807810	169
81432206090	0807811	163	81432206216	0807848	162	81432306043	0907216	162, 164, 169, 171
81432206091	0807833	164	81432206220	0807409	351	81432306049	0807818	169
81432206092	0807811	163	81432206221	0807840	166	81432306051	0907528	169, 172, 354
81432206093	0807833	164	81432206222	0807817	169	81432306060	0907217	355
81432206096	0807559	163	81432206224 *	0909984	350, 354, 391, 395	81432306068	0907528	169, 172
81432206097	0807559	163	81432206224	0807816	350	81432309037	0807216	162
81432206098	0807559	163	81432206227	0807806	350	81432309039	0807810	169
81432206099	0807822	352	81432206228	0807806	350	81432506007	0807917	169
81432206100	0807822	352	81432206232	0807906	164	81432506009	0907770	172
81432206103	0807822	352	81432206234	0807410	351	81432506009	0907917	169, 173, 306
81432206104	0907259	162-164, 171, 350-354	81432206236	0807407	163	81432506011	0807950	353
81432206106	0807818	169	81432206240	0807410	351	81432506017	0907950	353-354
81432206107	0907259	162-164, 171, 350-354	81432206241	0907919	165, 171	81432706030	0807533	165
81432206108	0907258	91, 163-164, 167, 171	81432206241	0909994	173	81432706034	0807533	165
81432206112	0807409	351	81432206247	0807820	162	81432706040	0907330	172, 354
81432206113	0807822	352	81432206248	0807819	350	81432706045	0907330	172, 354
			81432206250	0907362	393-394	81432706053	0807846	168
			81432206250	0907906	164, 171	81432706054	0807533	165
			81432206251	0807819	350	81432706055	0807533	165
			81432206254	0807819	350	81432706055	0807847	168
			81432206256	0807819	350	81432706056	0807847	168

O.E.	OCAP	PAG.	O.E.	OCAP	PAG.	O.E.	OCAP	PAG.
81432706057	0807533	165	81466106006	0507839	153	81466106785	0507809	345
81432706065	0907406	168, 172	81466106088	0506445	152	81466106790	0507820	157
81432706067	0807847	168	81466106159	0507958	152	81466106791	0507820	157
81432706068	0807847	168	81466106160	0507821	153	81466106794	0507952	346, 387
81432706074	0807533	165	81466106167	0507844	152	81466106795	0507791	345
81432706075	0807847	168	81466106200	0507958	152	81466106798	0507823	152
81432706076	0807533	165	81466106241	0507214	155	81466106807	0507917	155
81432706077	0807847	168	81466106275	0507958	152	81466106808	0507917	155
81432706078	0807533	165	81466106280	0506444	153	81466106809	0507408	155
81432706079	0907686	168, 173	81466106281	0506436	152	81466106810	0507408	155
81432706080	0907683	173	81466106288	0506445	152	81466106811	0507951	156
81432706081	0807847	168	81466106292	0509983	347	81466106812	0507951	156
81432706087	0807839	166	81466106300	0506436	152	81466106813	0509415	157
81432706088	0807839	166	81466106301	0507818	152	81466106823	0507408	155
81432706089	0907230	171	81466106303	0506436	152	81466106836	0507917	155
81432706091	0907846	168, 172	81466106304	0506436	152	81466106838	0507408	155
81432706094	0807839	166	81466106305	0507818	152, 345	81466106839	0507408	155
81432706095	0807839	166	81466106313	0509972	345	81466106840	0507951	156
81432706096	0807840	166	81466106317	0507958	152	81466106876	0507823	152
81432706097	0807842	167	81466106327	0506436	152	81466116003	0507409	157
81432706100	0907932	167, 173	81466106328	0507818	152	81466116004	0507409	157
81432706102	0807951	169	81466106329	0506436	152	81466116005	0507409	157
81432706105	0907907	166-167, 169, 172	81466106333	0506443	156	81466116006	0507406	157
81432706110	0907774	129, 131, 134-135, 166-167, 173	81466106334	0506443	156	81466116016	0507685	346
81432706113	0807842	167	81466106354	0506443	156	81466116017	0507549	346
81432706114	0807840	166	81466106355	0506443	156	81466116019	0507955	156, 345
81432706116	0807841	166	81466106360	0506443	156	81466116043	0507809	345
81432706117	0807907	165	81466106361	0506443	156	81466116044	0507952	346, 387
81432706118	0907840	166, 173	81466106374	0507955	156, 345	81466116045	0507791	345, 386
81432706119	0907919	165, 171	81466106375	0507685	346	81466116047	0507791	345
81432706121	0807840	166	81466106414	0507214	155	81466116049	0507791	345
81432706123	0907840	166, 173	81466106578	0507823	152	81466116064	0507958	152
81432706126	0907840	166, 173	81466106579	0507848	148, 343	81466116067	0509920	345
81432706127	0907362	351, 354	81466106580	0507848	148, 343	81466116081	0507809	345
81432706133	0907845	353-354, 393-394	81466106583	0507848	148, 343	81466116085	0507952	346, 387
81432706135	0807842	167	81466106598	0507823	152	81466116096	0507917	155
81432706137	0807841	166	81466106603	0507810	157	81466116097	0507917	155
81432706150	0807841	166	81466106606	0507212	346	81466116099	0507917	155
81432706151	0807841	166	81466106624	0507848	148, 343	81466116104	0507408	155
81432706160	0807842	167	81466106640	0507848	148, 343	81466116105	0507408	155
81432706161	0807842	167	81466106648	0507204	346	81466116107	0507408	155
81432709053	0807846	168	81466106654	0509977	346	81466116108	0507952	346, 387
81432709054	0807533	165	81466106656	0507406	157	81466116114	0507952	346, 387
81432709056	0807847	168	81466106659	0507406	157	81466116115	0507791	345
81432709078	0807533	165	81466106661	0509975	156	81466116120	0507952	346, 387
81432710027	0909990	171	81466106669	0507406	157	81466116126	0507791	345
81432710046	1216331	176	81466106684	0507685	346	81466116131	0509966	345
81432710081	1216334	176	81466106691	0509976	156	81466116132	0507917	155
81433150009	0907844	352, 354, 393, 395	81466106692	0507815	155	81466116133	0507917	155
81433156036	0807844	352, 393	81466106693	0507815	155	81466116134	0507408	155
81433156037	0807844	352, 393	81466106694	0509979	346	81466116135	0507408	155
81437040025	1214295	177	81466106695	0507815	155	81466116136	0507917	155
81437040029	1214294	177	81466106706	0507549	346	81466116137	0507408	155
81437040057	1216329	176	81466106708	0509920	345	81466116138	0507951	156
81437040061	1216333	176	81466106711	0507809	345	81466116139	0507951	156
81437040074	1216303	176	81466106721	0506443	156	81466116145	0507951	156
81437040077	1216306	176	81466106722	0506443	156	81466116146	0509415	157
81437220019	1216330	176	81466106723	0506443	156	81466116147	0509415	157
81437220059	1216319	176	81466106724	0506446	153	81466116148	0509415	157
81437220062	1216302	176	81466106725	0506446	153	81466116149	0509974	345
81437220063	1216305	176	81466106753	0507839	153	81466116150	0507204	346
81442040020	1216335	358	81466106754	0507839	153	81466116161	0509982	157
81466106001	0506446	153	81466106779	0507822	156	81466116197	0507917	155
81466106004	0507839	153	81466106780	0507822	156	81466116198	0507917	155
			81466106782	0507822	156	81466116199	0507408	155

O.E.	OCAP	PAG.	O.E.	OCAP	PAG.	O.E.	OCAP	PAG.
81466116200	0507408	155	81467106380	0507817	149	81467106994	0507581	150
81466116201	0507951	156	81467106388	0507847	149	81467107001	0507832	148
81466116202	0507951	156	81467106390	0507847	149	81467116711	0507843	150
81466116203	0507951	156	81467106393	0507847	149	81467116712	0507824	343
81466116204	0509415	157	81467106394	0507833	149	81467116715	0507894	343
81466116205	0507917	155	81467106394	0507847	149	81467116717	0507841	150
81466116206	0507408	155	81467106395	0507840	149, 343	81467116719	0507840	149, 343
81466116217	0507410	346	81467106396	0507808	149	81467116720	0507848	148, 343
81467106080	0507950	342	81467106397	0507808	149	81467116722	0507811	343
81467106081	0507806	342	81467106409	0507816	148	81467116723	0507835	151
81467106086	0507832	148	81467106410	0507816	148	81467116724	0507808	149
81467106112	0507807	150	81467106411	0507816	148	81467116725	0507807	150
81467106118	0507833	149	81467106418	0509981	157	81467116726	0507581	150
81467106118	0507847	149	81467106419	0507806	342	81467116728	0507841	150
81467106122	0507817	149	81467106420	0509967	342	81467116743	0507405	148
81467106131	0507808	149	81467106421	0507950	342	81467116744	0507405	148
81467106136	0507950	342	81467106434	0507819	148	81467116759	0507806	342
81467106137	0507806	342	81467106435	0507819	148	81467116762	0507950	342
81467106162	0507833	149	81467106436	0507216	155	81467116765	0507407	342
81467106163	0507807	150	81467106437	0507216	155	81467116766	0507407	342
81467106164	0507833	149	81467106438	0507845	148	81467116767	0507407	342
81467106164	0507847	149	81467106439	0507845	148	81467116770	0507743	342, 384
81467106165	0507807	150	81467106442	0507846	148	81467116771	0507957	342
81467106167	0507807	150	81467106443	0507846	148	81467116772	0507743	342, 384
81467106172	0507950	342	81467106444	0507806	342	81467116773	0507915	150
81467106173	0507806	342	81467106451	0507950	342	81467116780	0507957	342
81467106189	0507833	149	81467106453	0507407	342	81467116803	0507814	150
81467106189	0507847	149	81467106455	0507216	155	81467116810	0507405	148
81467106194	0507817	149	81467106457	0507407	342	81467116820	0507807	150
81467106195	0507817	149	81467106458	0507407	342	81467116845	0507824	343
81467106198	0507807	150	81467106459	0507742	343	81467116848	0507915	150
81467106236	0507835	151	81467106460	0507846	148	81467116858	0507915	150
81467106238	0507816	148	81467106806	0507742	343	81467116859	0507915	150
81467106240	0507816	148	81467106816	0507808	149	81467116860	0507915	150
81467106242	0507816	148	81467106818	0507742	343	81467116861	0507915	150
81467106265	0507808	149	81467106819	0507742	343	81467116862	0507915	150
81467106266	0507808	149	81467106830	0507817	149	81467116863	0507915	150
81467106267	0507835	151	81467106833	0507833	149	81467116874	0507743	342, 384
81467106268	0507835	151	81467106836	0507817	149	81467116875	0507743	342, 384
81467106280	0507958	152	81467106849	0507807	150	81467116876	0507743	342, 384
81467106294	0507806	342	81467106851	0507840	149, 343	81467116877	0507957	342
81467106295	0507950	342	81467106852	0507840	149, 343	81467116878	0507957	342
81467106313	0507958	152	81467106862	0507824	343	81467116879	0507957	342
81467106314	0507534	148, 343	81467106863	0507824	343	81467116882	0507915	150
81467106315	0507534	148, 343	81467106864	0507824	343	81467116883	0507915	150
81467106316	0507534	148, 343	81467106865	0507841	150	81467116884	0507405	148
81467106319	0507958	152	81467106866	0507841	150	81467116885	0507405	148
81467106325	0507832	148	81467106875	0507407	342	81467116886	0507954	342, 384
81467106337	0507950	342	81467106875	0507806	342	81467116888	0507915	150
81467106345	0507950	342	81467106876	0507950	342	81467116893	0507814	150
81467106353	0507807	150	81467106877	0507806	342	81467116894	0507814	150
81467106354	0507807	150	81467106879	0507806	342	81467116896	0507814	150
81467106355	0507835	151	81467106881	0507407	342	81467116897	0507954	342, 384
81467106356	0507835	151	81467106902	0507811	343	81467116898	0507954	342, 384
81467106359	0507808	149	81467106904	0507808	149	81467116899	0507954	342, 384
81467106360	0507808	149	81467106908	0507742	343	81467116920	0507915	150
81467106361	0507807	150	81467106909	0507824	343	81467116921	0507915	150
81467106362	0507808	149	81467106910	0507824	343	81467116930	0507915	150
81467106368	0507833	149	81467106912	0507817	149, 343	81467116933	0509417	151
81467106368	0507847	149	81467106926	0507405	148	81467116966	0509417	151
81467106369	0507833	149	81467106933	0507843	150	81467116972	0507957	342
81467106369	0507847	149	81467106934	0507843	150	814671406367	0507847	149
81467106373	0507835	151	81467106937	0507833	149	8151876	0287458	302
81467106378	0507817	149	81467106966	0509978	149	8154016	0807762	311
81467106379	0507817	149	81467106974	0507824	343	8154017	0807687	309

O.E.	OCAP	PAG.	O.E.	OCAP	PAG.	O.E.	OCAP	PAG.
8154018	0807687	309	81953016130	0287229	174, 356	81953016286	0188994	160
8154444	0509353	298	81953016131	0297229	174, 356	81953016288	0187723	161
8156123	0509900	289, 415	81953016132	0907533	165-166, 168, 171	81953016291	0287906	158
8158206	0807687	309	81953016133	0907534	165, 172	81953016302	0187228	174, 356
8158207	0807687	309	81953016134	0186595	158	81953016303	0186595	158
8163773	0506932	110	81953016135	0186613	158, 348	81953016304	0196595	158
8165309	0507288	111	81953016139	0196613	159, 348	81953016325	0187894	161, 349
8166702	0507371	119	81953016140	0186613	158, 348	81953016337	0287360	158
81767106879	0507807	150	81953016141	0196595	158	81953016345	0187410	349
8190146	0508800	297	81953016142	0186595	158	81953016355	0187410	349
8190147	0509350	297	81953016143	0186598	159, 348	81953020043	0407247	174
8190225	0196598	123	81953016149	0186598	159, 348	81953020077	0909991	355
8193645	0186613	122	81953016152	0196598	160, 349	81960200286	1216318	176
8193646	0196613	122	81953016154	0186598	159, 348	81962100278	1214293	177
8193649	0196595	122	81953016155	0196598	160, 349	81962100447	1216332	358
81953010013	0196424	159, 348	81953016156	0186598	159, 348	81962100450	1216304	176
81953010014	0186424	159, 348	81953016157	0196598	160, 349	81964010152	0909993	173
81953010015	0196598	160, 349	81953016162	0186424	159, 348	8198187	0287229	143
81953010016	0186598	159, 348	81953016163	0196424	159, 348	8198188	0297229	143
81953010022	0186758	160, 272, 349, 389	81953016168	0196598	160, 349	81991648156	0807810	169
81953010025	0187146	160	81953016169	0187228	174, 356	81998051662	0507951	156
81953010038	0187228	174, 356	81953016170	0287229	174, 356	8200002868	1215640	48-50, 61-63
81953010040	0289962	158	81953016171	0297229	174, 356	8200002869	1215641	48-50, 62-63
81953010045	0187228	174	81953016172	0187228	174, 356	8200002870	0503878	49-50, 62-63
81953010064	0186424	159, 348	81953016173	0287229	174, 356	8200247898	0793808	48, 61
81953010067	0186424	159	81953016174	0297229	174, 356	8200247900	0783808	48, 61
81953010074	0196424	159, 348	81953016176	0187228	174, 356	8200395007	0394627	49, 62
81953010077	0186595	158	81953016178	0186598	159, 348	8200395034	0384627	49, 62
81953010078	0196595	158	81953016179	0196598	160, 349	8200626959	0394627	49, 62
81953010079	0196613	159, 348	81953016184	0186598	160	8200626961	0384627	49, 62
81953010082	0196424	159	81953016194	0186598	159, 348	8200688832 Z	1216016	47, 59
81953010084	0186598	159, 348	81953016200	0189965	174	8200688871	0391536	47, 59
81953010087	0196598	160, 349	81953016219	0287906	158	8200688875	0381536	47, 59
81953010089	0187410	349	81953016222	0196613	159, 348	8200688877	0401536	47, 59
81953010091	0187463	160	81953016223	0196598	160, 349	8200876657	0384627	49, 62
81953016016	0187228	174	81953016224	0186598	159, 348	8200876659	0394627	49, 62
81953016030	0196598	160, 349	81953016225	0287906	158	8226232000	0807420	373
81953016043	0196598	160, 349	81953016226	0287906	158	8226241000	0807420	373
81953016048	0186598	159, 348	81953016233	0287907	349	8226244000D	0507424	359
81953016049	0186598	159, 348	81953016234	0186598	159, 348	8226247000C	0507429	359
81953016050	0196598	160, 349	81953016235	0187228	174, 356	8226248000C	0507425	359
81953016053	0186598	159, 348	81953016236	0187783	160	8226258000C	0507424	359
81953016054	0196598	160, 349	81953016237	0196598	160, 349	82262800000	0507427	365
81953016060	0186613	158, 348	81953016239	0186424	159, 348	8226280000B	0507427	365
81953016063	0297229	174, 356	81953016242	0186598	159, 348	8226280000C	0507427	365
81953016064	0287229	174, 356	81953016246	0186424	159	8226293000B	0807590	372
81953016067	0186424	159, 348	81953016248	0189964	174	8226306000	0507424	359
81953016068	0196424	159, 348	81953016249	0186613	158, 348	8226308000	0507425	359
81953016070	0197146	160	81953016250	0186424	159, 348	8226308000C	0507425	359
81953016071	0287684	158	81953016255	0287907	349	8226318000B	0807415	373
81953016087	0196598	160, 349	81953016261	0197146	160	8226323000B	0807415	373
81953016090	0186598	159, 348	81953016263	0186442	161	82263260000	0507423	359
81953016091	0196598	160, 349	81953016266	0187228	174, 356	82263280000	0507423	359
81953016092	0187349	161	81953016267	0287906	158	8226330000	0507421	359
81953016093	0197523	161	81953016268	0289923	86, 121, 158, 302	8226330000C	0507421	359
81953016095	0287684	158	81953016270	0187843	161, 349	8226347000	0507429	359
81953016096	0187838	158	81953016271	0187894	161, 349	8226355000	0507427	365
81953016106	0287684	158	81953016274	0186598	159, 348	82263550000	0507427	365
81953016107	0196598	160, 349	81953016275	0196598	160, 349	8226357000	0807420	373
81953016108	0186598	159, 348	81953016276	0186599	160	8226380000	0507428	363
81953016112	0186598	159, 348	81953016277	0287907	349	8226380000C	0507428	363
81953016120	0196598	160, 349	81953016278	0186598	159, 348	8226381000	0507425	359
81953016125	0196598	160, 349	81953016279	0196598	160, 349	82466106080	0507955	156, 345
81953016126	0186598	159, 348	81953016280	0287361	158	82466106189	0507955	156, 345
81953016127	0189963	174	81953016281	0287360	158	82466106190	0507955	156, 345

O.E.	OCAP	PAG.	O.E.	OCAP	PAG.	O.E.	OCAP	PAG.
82466106191	0507820	157	85466106231	0507217	152	9014600348	0281503	31, 66, 366
8246610691	0507820	157	85466106235	0507956	155	9014600455	0601504	31, 66
82467106016	0507833	149	85466106246	0507812	154	9014605500	0901504	31, 40, 66
82953010010	0287361	158	85466106247	0507813	153	9063201789	0592743	33, 66
82953016016	0287360	158	8550139	0187228	143	9063201889	0582743	33, 66
82953016018	0289923	86, 121, 158, 302	8557536	0506725	112	9063304007	0792742	33, 65
82953016019	0289923	86, 121, 158, 302	8558522	0506726	114	9063330014	1215874	33, 65
83466106001	0507410	346	8558524	0196612	122	9064600048	0282717	32, 65
83466106501	0507410	346	8558527	0186612	122	9064600055	0602741-K	32, 65
85.43220.6002	0907407	163, 170, 172	8558533	0186613	122	9064600096	0902741	32, 65
85104265	0509892	416	8558536	0196613	122	90804105207	0287294	174, 356
85104266	0288781	419	8558540	0506728	113	90804153107	0196424	159, 348
85112073	0187959	303	8558541	0506728	113	90804153111	0186424	159, 348
85114167	0509892	416	8558647	0506733	102	90804153113	0196424	159, 348
85114187	0509352	298	8558651	0506991	102	90804154117	0187146	160
85115631	0509894	290	8558653	0507153	103	91160038	0903807	48-49, 61, 63
8525704	0506993	102	8559559	0506726	114	91166461	0783808	48, 61
8526148	0506733	102	8564248	0506737	113	91166462	0793808	48, 61
8533963	0507171	102	8564386	0507290	108	9160392	0391494	43, 45, 58
8535664	0506991	102	8565366	0186608	122	9160393	0381494	43, 45, 57
85432206002	0907407	163, 170, 172, 350, 354, 394	8567618	0506736	112	9160394	1215609	43, 45, 58
85432706001	0809989	167	8567619	0506736	112	9160395	1215610	43, 45, 58
85461106141	0507217	152	8570528	0506812	112	9160498	0593812	44, 46, 58
85466106005	0507217	152	8573757	0507164	112	9160499	0583812	44, 46, 58
85466106007	0507559	154	8578492	0187234	143	9160555	0401494	43, 45, 57
85466106012	0507842	153	8578493	0187226	143	9161560 Z	1211392	46, 57, 59
85466106018	0507956	155	8580735	0286616	141	9161560	0903811	46, 59
85466106019	0507215	154	8582313	0187226	143	9161561	0603811-K	45
85466106020	0507815	155	8582320	0507290	108	9161562	0291495	43, 45, 57
85466106021	0507533	153	8582322	0186613	122	9161563	0281495	43, 45, 57
85466106026	0507953	156	8582332	0186608	122	9281792	0287291	121
85466106030	0506446	153	8582333	0196608	122	93157156	0287320	121
85466106031	0507839	153	8582350	0506736	112	93161371	0907578	126
85466106052	0509969	154	8590435	0506887	112	93161631	0907299	132, 136
85466106102	0506446	153	8591219	0506737	113	93161638	0907299	132, 136
85466106104	0507839	153	8591222	0506726	114	93161884	0404627	48, 62
85466106105	0507217	152	86011651	0506827	109	93161958	0907297	131-132, 135
85466106107	0507559	154	86012923	0506904	108	93161960	0907296	132, 135
85466106108	0507537	154	86012924	0507323	108	93162239	0907297	131-132, 135
85466106112	0507842	153	86018015	0506827	109	93162361	0907296	132, 135
85466106118	0507956	155	86027074	0187228	340	93163617	0907927	136
85466106119	0507215	154	8788387	0506738	103	93163964	0809418	134
85466106121	0507533	153	8788641	0506740	103	93165049	0807326	129
85466106126	0507953	156	9009500	0506725	112	93167687 Z	0601536	46, 59
85466106140	0507533	153	9009501	0186614	121	93167687	0901536	46, 58
85466106141	0507217	152	9009503	0196614	121	93167688	0291536	46, 58
85466106142	0507842	153	9013200089	0104151	32, 67	93167689	0281536	46, 58
85466106143	0507559	154	9013200289	0591514	32, 67	93192361	0907327	126-127, 131, 134-135, 336-337
85466106144	0507537	154	9013200389	0581514	32, 67	93192618	0907304	128, 136
85466106150	0507215	154	9013200589	0502379	32	93192618	0907331	337
85466106151	0507815	155	9013200689	0502368	32	93192619	0907330	126, 128, 136
85466106152	0507956	155	9013301807	0791505	31, 67	93192809	0287238	124, 332
85466106153	0507953	156	9013301907	0781505	31, 67	93194457	0907331	337
85466106156	0509970	154	9013302507	0781505	31, 67	93194458	0907260	335, 337
85466106160	0507812	154	9013330214	1215705	32, 67	93194626	0186612	122
85466106163	0509971	154	9013330627	0401505	31, 66	93194627	0196612	122
85466106201	0506446	153	9013330727	0401505	31, 66	93197214	0391536	47, 59
85466106205	0507217	152	9013331027	0401505	31, 66	93197215	0381536	47, 59
85466106208	0507537	154	9013331127	0401505	31, 66	93197216 Z	1216016	47, 59
85466106212	0507842	153	9013331227	0401505	31, 66	93197232 Z	1216017	47, 59
85466106218	0507956	155	9014600048	0281503	31, 66, 366	93197233	0401536	47, 59
85466106219	0507215	154	9014600148	0281503	31, 66, 366	93197325	0501536	47, 59
85466106226	0507953	156	9014600155	0601504	31, 66	93197332	0501496	47, 59
85466106230	0507839	153	9014600205	0501503	31, 66	93800662	0280515	121
			9014600255	0601504	31, 66			

O.E.	OCAP	PAG.	O.E.	OCAP	PAG.	O.E.	OCAP	PAG.
93802209	0280517	26, 28, 137, 141	9453300103	0507916	182	9704600705	0507613	189
93802242	0400518	26, 137, 141	9453300203	0507651	178	9704600805	0508949	189
93804059	0280515	121	9453300303	0507651	178	9704600905	0507613	189
93804060	0280517	137, 141	9453300403	0507916	182	97104296	0807326	129
93807320	0400518	141	9453300503	0507651	178	97104299	0807328	134
93807545	0400518	137, 141	9453300603	0507916	182	9724601005	0508955	192
93807640	1215270	27	9453500105	0808975	213	9724601405	0507439	189
93807641	1215269	27	94613	0507799	83	9724601605	0507439	189
93810239	1215271	27	9473500005	0807669	207	9724601805	0507827	195
93853465	0384627	49, 62	9473500105	0807634	214	9724601905	0507434	195
9386136	0394627	49, 62	9473500705	0807774	215	9724602005	0507827	195
93862135	0384627	49, 62	9473500905	0807774	215	9724602105	0507434	195
94038	0506430	82	9473501005	0807634	214	9743500005	0808987	221
9403817738	0282733	11, 19, 55	9483500405	0807774	215	9744601005	0507887	195
9404059080	0280037	10, 18, 54	9483500605	0807669	207	9744601105	0507963	195
9404066838 *	1211477	12, 19, 56	9483500805	0807669	207	9744601205	0507887	195
9404066838	0902733	12, 20, 56	9483500905	0808986	221	9744601305	0507963	195
9413230050	1216337	232	9483501105	0807774	215	9750000280	1211064	13
9413300007	0807636	222	9483501205	0807669	207	9750000380	1211063	13
9413300011	0807671	221	9483501305	0807669	207	9750079980	0280513	13, 121
9413300103	0507643	182	9483502005	0807669	207	9750390080	0600514	13
9413300203	0507643	182	9483502205	0807908	213	9753300203	0507975	180
9413300303	0507643	182	9483502305	0807908	213	9753300303	0507975	180
9413300503	0507643	182	9483502405	0807669	207	9753300803	0507975	180
9423260050	1216338	232	9483502805	0808985	220	9753301703	0507975	180
9423300003	0507633	182	9483502905	0808982	215	9753302503	0507975	180
9423300103	0507633	182	9483503005	0807774	215	9790002680	0501112	13
9423300203	0507633	182	948372	0109903	320, 425	98402544	0506951	113
9423300303	0507886	182	9493300203	0507591	180	98402553	0506950	108
9423300403	0507886	182	9493300303	0507591	180	98420110	0506410	329
9423300403	0507979	181	9493300403	0507604	182	98420112	0506410	329
9423300703	0507633	182	9493300503	0507604	182	98427667	0506817	110
9423300803	0507591	180	9493300603	0507603	182	98446354	0506894	116
9423301003	0507431	365	9493300703	0507603	182	98449025	0506956	114
9423301103	0507633	182	9493300803	0507604	182	98458724	0506817	110
9423301603	0507886	182	9493300903	0507591	180	98467459	0506951	113
9423301603	0507979	181	9493301003	0507436	180	98469650	0506956	114
9423301703	0507431	365	9493301103	0507436	180	98470968	0506994	109
9423301803	0507633	182	9493301403	0507604	182	98472466	0807358	127
9423302003	0507633	182	9493301503	0507603	182	98472468	0807296	131
9423302303	0507633	182	9493301603	0507603	182	98472871	0807336	127
9423302403	0507979	181	9493301703	0507436	180	98473328	0507850	117, 330
9423302503	0507431	365	9493301903	0507604	182	98484091	0507335	142
9423500105	0807984	215	9493302003	0507603	182	98488010	0807209	126
9423500505	0807599	213	9493302303	0507604	182	98488010	0807213	126, 334
9423500705	0807984	215	9493302403	0507603	182	98488013	0507335	142
9423500805	0807599	213	9519279	0507686	416	98489741	0506412	329
9423500905	0808981	214	9522701	0508791	416	98491559	0506413	331
9423501005	0807634	214	9523794	0809364	420	98493054	0507851	115
9423501105	0807984	215	9523795	0809365	420	99432053	0509370	329
9423501205	0807599	213	9566950880	0600918	11, 18, 55	99432565	0807339	334
9423501505	0807634	214	9574600405	0508939	184	99439665	0807341	335
9423501605	0807984	215	9574600505	0507972	190	99455009	0507367	115, 330
9443300203	0507910	179	9574600705	0507972	190	9945836	0601139	7, 14, 51
9443300503	0507969	179	9603172112	1216346	232	9945837	0900449	7, 15, 51
9443301303	0507969	179	9603172212	1216347	232	99458576	0809418	134
9443301703	0507437	179	9603231085	1216342	232	99463268	0607552	28, 125
9443301703	0507669	179	9603231285	1216345	232	9946982	0900489	7, 14, 51
9443500005	0807634	214	9603232085	1216344	232	9946982	1211310	7, 14, 51
9443500305	0807774	215	9603232285	1216341	232	99484068	0807341	335
9443500405	0808980	214	9603233785	1216343	232	9959151	0507224	288
9443500505	0807774	215	9603300403	0509442	183	9959153	0507222	292
9453300003	0507916	182	9603500906	0809444	222	9959503	0508783	425
9453300007	0807635	222	9604630815	0509479	197	9983325	0600516	26, 125
9453300011	0807670	221	9703300003	0509391	181	A0004634429	0287361	200, 366

O.E.	OCAP	PAG.
A0009964845	0287361	200, 366
A0034608005	0509479	197
A3574602405	0507422	364
A3574603105	0507422	364
A3574603205	0507426	363
A3574603505	0507431	365
A6273300203	0507423	359
A6284600205	0507432	365
A6284600305	0507430	363
A6284601205	0507430	363
A9604630815	0509479	197
ACU9239	0197803	90
ACU9240	0187803	90
ACU9241	0196613	86
ACU9242	0186613	86
AFRA635	0197928	88
AFRA888	0187803	90
BK213059A	1216246	24-25
BK213A262AC	1216245	24-25
EAX1458	0289929	90
EAX1459	0299929	90
HJK3892	0506167	76
KT6C113K209AA	0403867	22, 24
MAK1295	0196424	87
MAK1296	0186424	86
NAK3394	0197785	87
NAK3395	0187785	87
PAX1458	0299929	90
PAX1459	0289929	90
RAK1390	0509930	76
S009593	0507924	79, 266, 325
X50561	0807507	92

O.E.	OCAP	PAG.
------	------	------

O.E.	OCAP	PAG.
------	------	------

OCAP	O.E.	PAG.	OCAP	O.E.	PAG.	OCAP	O.E.	PAG.
0101724-K	6150970	22	0186599	0003401207	250	0187234	8578492	143
0104151	2D0511329	32, 67	0186599	0013301835	203	0187241	1527234	322
0109903	948372	320, 425	0186599	4688948	123, 332	0187278	2981461	122
0180727	6013300435	34, 38	0186599	81953016184	160	0187342	0004604348	201, 367
0180727	6013305335	200	0186601	814304	105	0187342	120326100	388
0180729	0013300735	204, 370	0186603	4018036	105	0187346	260	
0180730	0004604148	35	0186604	4028250	105, 123, 332	0187349	81953016092	161
0180730	3103301335	200, 366	0186605	4664297	105, 332	0187364	500309296	124
0180730	5001836801	248	0186608	1689604	86	0187410	81953016355	349
0180947	7701461770	60	0186608	4688941	122	0187435	0014605648	369
0181322	508735	11, 19, 55	0186612	0003301235	38	0187456	1668179	322
0181322-K	1308664080 *	11, 19, 55	0186612	0003309735	201, 367	0187460	-	388
0181401	7701013272	63	0186612	120324001	388	0187463	0697221	89
0181602	1300716080	9, 16, 53	0186612	1696919	302	0187463	122169000	389
0181602-K	1300716080	9, 17, 53	0186612	8558527	122	0187463	81953010091	160
0181724	6150970	22	0186613	0003309335 35-37, 39, 201, 367		0187465	120110403	388
0181785	42042912	143	0186613	0607451	86	0187467	0004601748	203
0182252	6083330027	34	0186613	120325701	388	0187467	120322305	389
0182254	6023300035	34	0186613	1698191	302	0187467	6.851.491.000	369
0182259	6313300535	30, 418	0186613	42484886	122	0187476	122169500	390
0182260	0004607248	30	0186613	5000823987	248	0187530	0698586	89
0182260	0013304835	366	0186613	81953016060	158, 348	0187560	0013301435	36-40, 200
0182260	4603301235	201	0186614	4579231	121	0187571	120326400	389
0182261	0004606548	366	0186620	4661613	333	0187682	382613	322
0182261	6313380310	30	0186648	4665007	105	0187686	3093647	304, 418
0182344	-	249	0186649	4665005	105	0187723	1357674	273
0182345	-	249	0186651	4664345	105	0187723	1603883	89
0182346	-	250	0186653	4664343	105	0187723	20894438	304
0182638	1350658080 Z	10, 18, 54	0186655	4688952	124	0187723	5001852452	251
0186167	-	88	0186656	4688951	124	0187723	81.95301.6288	161
0186168	1604248	89	0186657	4520697	106	0187759	638869	278, 284
0186421	10229	75	0186684	4580778	106	0187772	639362	278, 281
0186422	101347	75	0186758	0609643	89	0187783	1320855	89
0186424	0014603448	202	0186758	81953010022 160, 272, 349, 389		0187783	3093714	304
0186424	0586753	86, 328	0186946	3090727	303, 418	0187783	81953016236	160
0186424	082192300	389	0186948	1698047	303	0187785	NAK3395	87
0186424	1697247	303, 418	0186949	41005523	143	0187789	0014604148	204
0186424	2966688	123	0186959	1698846	303, 418	0187803	ACU9240	90
0186424	5000295214	249, 398	0186960	1695776	303, 408, 418	0187838	325615	272
0186424	579342	332	0186961	0004606848	205	0187838	81953016096	158
0186424	6851516000	367	0187125	000978	327	0187843	1389190	89
0186424	81953016239	159, 348	0187137	0004607748	368	0187843	81953016270	161, 349
0186442	6994601648	204	0187146	0004602648	202, 369	0187854	-	250
0186442	81953016263	161	0187146	0069867	87	0187856	-	250
0186547	0013300335	202, 367	0187146	120326000	389	0187884	5001860770	248
0186551	0004606848	203, 368	0187146	2980875	123	0187891	0023123262 *	251
0186592	11200360-0	235	0187146	5000808458	250	0187894	1723897	272, 408
0186595	0003308535	200, 366	0187146	90804154117	160	0187894	1785340	89
0186595	0608530	86	0187152	4580782	106	0187894	81953016271	161, 349
0186595	1518142	302, 418	0187156	2463583	137, 141	0187900	5000297580	251, 305
0186595	42491937	122	0187157	2460515	137, 141	0187903	5001867774	250
0186595	5000814097	248	0187158	61595957	122	0187916	0014602948	204
0186595	81953016142	158	0187160	4688944	124	0187959	0014603848	202
0186598	0004602848	202, 368	0187166	4664340	332	0187959	85112073	303
0186598	004206	327	0187226	8578493	143	0187971	0004604848	204
0186598	101694	75	0187228	0002684889	228	0188932	0003384923	201
0186598	120325000	389	0187228	1278679	286	0188933	0014608248	202
0186598	1257890	87, 328	0187228	1672152	322	0188934	0003300827	368
0186598	1358793	272, 408	0187228	386930	99	0188935	3103300035	369
0186598	20742127	304	0187228	5010245591	260	0188994	1534756	272
0186598	2966252	332	0187228	81953010038	174, 356	0188994	1685552	89
0186598	4833829	123	0187228	8550139	143	0188994	20937674	304
0186598	5000242479	249	0187228	86027074	340	0188994	42538384	124
0186598	5000288360	398	0187230	350270	286	0188994	6293380010	369
0186598	81953016234	159, 348	0187231	1383405	286	0188994	7420937674	251

OCAP	O.E.	PAG.	OCAP	O.E.	PAG.	OCAP	O.E.	PAG.
0188994	81953016286	160	0196612	1696920	302	0284249	6384600048	41
0189360	3097999	304	0196612	8558524	122	0284333	7H0422818D	73
0189896	21263974	304	0196613	0003309435	201, 367	0286427	0606923	88, 328
0189914	20581089	304	0196613	0607452	86	0286428	0067389	88
0189926	1401944	87	0196613	120325702	388	0286606	4510017	106
0189963	81953016127	174	0196613	1698190	302	0286610	4664353	107
0189964	81953016248	174	0196613	42484887	122	0286616	500337201	26, 141
0189965	3124625	322	0196613	5000823997	248	0286641	5000288362	251
0189965	81953016200	174	0196613	81953010079	159, 348	0286647	4665009	106
0189995	0009965245	228	0196614	4579232	121	0286650	4514245	106
0189996	0009966845	228	0196620	4661614	333	0286652	4582159	106
0189997	0002685989	228	0196758	1337366	272	0286658	4665422	107
0190727	6013300535	34, 38, 200	0196946	3090728	303	0286659	4536229	105
0190729	0013300835	204, 370	0196959	1698847	303, 418	0286665	4025438	106
0190731	0004602248	204	0196960	1698840	304, 418	0286666	4533777	106
0190731	0004608748	35	0196961	0004606948	203	0286759	310980	273
0191401	7701013276	64	0197125	000192	327	0286964	1699401	305, 418
0191724	6150971	22	0197137	0004607848	368	0287136	0013302135	203, 369, 390
0192252	6083380110	34	0197146	6851532000	369	0287150	4664090	106
0192254	6023300135	34	0197146	81953016261	160	0287151	4664092	106
0192258	6313380410	30	0197166	4664341	333	0287159	4688946	124
0192260	6313300435	30	0197342	120326200	388	0287229	0002686289	228
0192345	-	249	0197463	122169100	389	0287229	1696685	322, 426
0196167	-	88	0197467	120322300	390	0287229	305320	286
0196168	1703473	89	0197467	6.851.490.000	203, 369	0287229	5010129530	260
0196421	30042	75	0197523	0638680	90	0287229	589333	99
0196422	101348	75	0197523	638680	278-279, 284	0287229	81953016064	174, 356
0196424	0013308835	202	0197523	81953016093	161	0287229	8198187	143
0196424	082192200	389	0197751	639361	278, 281	0287238	93192809	124, 332
0196424	1319838	87, 328	0197756	5000297581	251	0287291	0817824	86
0196424	1698839	303	0197785	NAK3394	87	0287291	120164610	388
0196424	2980129	123	0197803	ACU9239	90	0287291	7485114029	248
0196424	5000295215	249	0197854	-	250	0287291	9281792	121
0196424	579343	332	0197884	5001860769	248	0287294	42071290	143
0196424	6851516000	367	0197928	1401942	88	0287294	90804105207	174, 356
0196424	81953010074	159, 348	0197971	0004608448	204	0287313	42105474	121
0196547	-	204	0198931	0003301135	201	0287313	6244600348	200
0196592	11200361-0	235	0198935	3103300135	369	0287319	42485639	143
0196595	0003308635	200, 366	0199914	20710008	304	0287320	42530316	121
0196595	1517448	302, 418	0199928	1310760	89	0287350	5000803460	251
0196595	42480023	122	0280037	405909	10, 18, 54	0287360	0014606948	366
0196595	5000814096	248	0280056	251419811	67	0287360	1394444	272
0196595	81953016141	158	0280513	9750079980	13, 121	0287360	42533101	121
0196598	0004603448	203, 368	0280515	1903652	26	0287360	5001849880	248
0196598	004204	327	0280515	93800662	121	0287360	82953016016	158
0196598	101695	75	0280517	93802209	26, 28, 137, 141	0287361	0004634429	200, 366
0196598	120325200	389	0281143	1306716080	7, 14, 51, 123	0287361	122162800	388
0196598	1228115	87, 328	0281405	701419812	68	0287361	1394443	272
0196598	20745042	304	0281407	701419812A	69	0287361	42533073	121
0196598	283783	272, 408	0281411	701419812B	71	0287361	5001849879	248
0196598	4833830	123	0281413	701419812D	71	0287361	81953016280	158
0196598	5000242478	250	0281495	7701470364	43, 45, 57	0287457	1624093	302
0196598	574274	332	0281503	9014600348	31, 66, 366	0287458	8151876	302
0196598	81953016237	160, 349	0281536	4420098	46, 58	0287466	120110404	388
0196599	0003401206	250	0281725	10391031	21	0287503	0273203	86
0196599	4688949	123	0281786	42041327	143	0287519	0608122	90
0196601	814305	105	0281904	6384600048	40, 366	0287552	42534911	26, 28, 332
0196603	4018037	105	0282240	7701462427	57	0287646	0002685589	228
0196604	4028251	105, 332	0282323	77362278	7, 14, 51	0287684	0004604948	201
0196605	4523292	106	0282637	381770	9, 17, 53	0287684	1375228	272
0196608	1689605	86	0282717	9064600048	32, 65	0287684	1066980	302
0196608	4688942	122	0282733	381773	11, 19, 55	0287684	81953016106	158
0196612	0003301335	38	0283815	77362279	18	0287724	1235514	88
0196612	0003309835	201, 367	0283867	1138275	22, 24	0287752	5000803464	251
0196612	120324002	388	0283875	7701049283	47, 49, 61-62	0287753	5000297668	251

OCAP	O.E.	PAG.	OCAP	O.E.	PAG.	OCAP	O.E.	PAG.
0287881	6851529000	368	0381141	1308601080	7, 15, 51	0403877	-	48, 61
0287892	5000288364	250	0381184	71737048	11, 19, 55	0404001	251407187C	68
0287906	42533102	121, 158	0381446	1339467080	8, 15, 52	0404260	-	41
0287907	0004606748	370	0381451	1339466080	8, 16, 52	0404335	7H8407361A	73
0287907	81953016233	349	0381494	7700309190	43, 45, 57	0404336	7H0407361	73
0288003	-	124	0381536	4419216	47, 59	0404627	7701477385	48, 62
0288779	20374698	302	0382638	3521P1	10, 17, 54	0405069	542410025	29
0288781	85104266	419	0382639	3521P2	10, 18, 54	0407219	5000489779	401
0288930	0014601648	200	0382723	7H0407152F	73	0407232	307443	286
0288930	5001830480	248	0382734	3521N9	12, 20, 56	0407247	81953020043	174
0288993	3193731	303	0383875	4422270	50, 63	0407249	-	26
0288993	7403193731	249	0384627	8200876657	49, 62	0407249	500379801	138-139, 141
0289425	42569563	124	0385072	542150012	29	0407250	-	27
0289426	42569562	124	0390405	4391814	13	0407250	500334716	138, 140-141
0289455	1394447	273	0390406	7695191	14	0407893	504212586	28, 141
0289456	21431678	305	0390565	7695186	14	0407894	5801378064	28, 141
0289456	7421431678	252	0391140	1320755080	8, 16, 52	0408780	20739867	424
0289476	500053864	124	0391141	1308600080	7, 15, 51	0409422	5801564293 *	139, 141
0289923	1271126	86, 121, 158, 302	0391184	71737047	11, 19, 55	0409423	5801564316 *	139, 141
0289927	1344684	87	0391446	1339465080	8, 15, 52	0409919	5010556210	338
0289929	6K13312	90	0391451	1339464080	9, 16, 53	0500730	3094600305	35
0289962	81953010040	158	0391494	7700309189	43, 45, 58	0500730	6014600305	184
0289986	1603788	88	0391536	4419215	47, 59	0501112	9790002680	13
0289998	0009965045	228	0392638	3520S0	10, 17, 54	0501347	6014300535	35
0289999	0009966645	228	0392639	3520S1	10, 18, 54	0501443	7D0411049	69, 72
0291405	701419811A	68	0392723	7H0407151F	73	0501496	4419304	47, 59
0291407	701419811B	69	0392734	3520R8	12, 20, 56	0501499	6673300603	37, 180
0291411	701419811C	71	0393875	4422269	50, 63	0501501	251419803	67
0291413	701419811E	71	0394627	8200876659	49, 62	0501503	9014600205	31, 66
0291495	7701470363	43, 45, 57	0395072	542150011	29	0501536	4419291	47, 59
0291536	4420097	46, 58	0400096	7567284	13, 137	0501904	6384600205	40
0291786	42041328	143	0400097	4388159	13, 137	0502230	7701463035	60
0292637	381777	9, 17, 53	0400518	93802242	26, 141	0502231	7701462987	60
0293875	7701049282	47, 49, 61-62	0400518	93807545	137	0502252	6083300303	33
0294249	6394600048	41	0400888	251407361	68	0502253	6023300403	34
0294333	7H0422817D	73	0400889	251407187A	68	0502254	6023300903	34
0296427	0606922	88, 328	0400951	5000246731	64	0502255	6083300403	34
0296428	0067303	88	0400952	5000246732	64	0502256	6084600105	34
0296606	4510018	107	0401127	1055194	21	0502257	6014600505	35
0296610	4664351	107	0401127-K	-	21	0502257	6014601505	184
0296641	5000288363	252	0401137	1302368080	7, 15, 51, 137	0502258	6313300303	30
0296759	310979	273	0401138	1300473080	8, 15, 52, 137	0502259	6313300603	30, 359
0296964	1699400	305, 419	0401398	5000246729	64	0502260	6313300703	30
0297136	0013302235	203, 369, 390	0401399	5000246730	64	0502261	6314600705	30
0297229	0002686189	228	0401409	701407187B	69, 71	0502368	9013200689	32
0297229	1249088	99	0401410	701407361B	69, 71	0502379	9013200589	32
0297229	1696684	322, 426	0401425	7D0407361	71	0502735	508756	12, 20, 56
0297229	305319	286	0401446	1331640080	8, 15, 52, 137	0502744	6013201389	33, 66
0297229	5001000134	260	0401451	1331641080	8, 16, 52, 137	0503254	4519467	23, 25
0297229	81953016063	174, 356	0401494	7700312852	43, 45, 57	0503520	1355449080 Z	10, 18, 54
0297229	8198188	143	0401505	9013331227	31, 66	0503864	701411049B	70, 72
0297350	5000803459	251	0401522	7700312851	43, 46, 58	0503870	3736028	23
0297519	0608123	90	0401523	4401910	46, 58	0503871	4042068	24
0297724	1235515	88	0401536	4419219	47, 59	0503872	4440885	24
0297752	5000803465	251	0401906	6383330027	40	0503878	8200002870	49-50, 62-63
0297753	5000297669	251	0402159	0003200028	31, 35	0504160	6383260116	41
0297796	1205248	88	0402159	6313200228	227, 379	0504337	7H5411317A	74
0297892	5000816456	250	0402235	7701461667	61	0506167	HJK3892	76
0299929	PAX1458	90	0402241	7701462692	57	0506168	1407963	76
0299998	0009965145	228	0402242	7701462693	57	0506410	98420110	329
0299999	0009966745	228	0402638	364067	9, 17, 53	0506412	98489741	329
0380405	4391813	13	0402742	-	33, 65	0506413	98491559	331
0380406	7695190	13	0403867	1417351	22, 24	0506429	0094029	81
0380565	7695185	14	0403869	4381927	22, 24	0506430	0094038	82
0381140	1308760080	8, 16, 52	0403875	4422270 *	50, 63	0506431	0094016	80

OCAP	O.E.	PAG.	OCAP	O.E.	PAG.	OCAP	O.E.	PAG.
0506432	1286343	77	0506736	8567618	112	0506933	432698	407
0506433	1291060	83	0506737	8591219	113	0506936	1112511	267
0506434	1283212	80	0506738	8788387	103	0506937	1409918	265
0506435	1283211	81	0506740	8788641	103	0506938	466881	406
0506436	81466106304	152	0506741	61590910	118	0506939	395350	264
0506443	81466106721	156	0506743	61593332	116	0506939	5000613598	238
0506444	81466106280	153	0506745	61595371	118	0506950	98402553	108
0506445	81466106288	152	0506746	61595960	119	0506951	98402544	113
0506446	81466106725	153	0506750	4666991	104	0506952	4854874	115
0506542	7166384	108	0506751	5000785429	242	0506953	4854871	109
0506553	4835068	109	0506753	4520698	102	0506955	42118693	108
0506575	6204602805	193	0506754	5010308082	237	0506956	98469650	114
0506576	6754602205	188, 363	0506755	42102058	110	0506962	6474600005	191
0506577	6764601105	188, 363	0506760	4711108	331	0506963	3834604405	194
0506578	6194605205	190	0506762	42044493	329	0506965	1626493	291
0506579	3874604805	193	0506764	4765442	120	0506966	1588017	292
0506580	3874604405	190	0506774	4659860	331	0506967	1626751	294
0506581	6754602405	187, 363	0506781	4672795	331	0506968	1613562	294
0506582	0014602905	189	0506788	42026853	110	0506969	1606283	296
0506583	6734600605	186	0506794	42037655	110	0506971	4668258	104
0506584	3834604505	194	0506795	2506671	330	0506976	4588688	102
0506585	0004607105	193	0506810	4704183	117	0506977	4568702	102
0506586	6773300303	179	0506811	4741957	331	0506981	4574457	104
0506588	11200265-0	233	0506812	8570528	112	0506984	4520744	104
0506590	11200454-0	234	0506814	2458534	113	0506987	4545422	104
0506591	11505036-0	234	0506816	278665	269	0506991	8535664	102
0506595	5000393080	236	0506817	98458724	110	0506993	8525704	102
0506613	60103171	108	0506818	42100262	109	0506994	98470968	109
0506642	5010130453	245	0506820	4834037	118	0507100	1592940	293
0506676	5010144552	245	0506826	4793166	118	0507101	1592939	293
0506677	5010144556	245	0506827	86011651	109	0507102	1606284	296
0506678	5010239340	246	0506828	42202358	116	0507103	1606282	298
0506679	5010060764	241	0506829	352637	269	0507104	1626750	294
0506680	5000787472	242	0506839	4715615	117	0507105	1080788	293
0506681	5010294287	241	0506840	42087842	118	0507106	1080787	294
0506682	5010294502	242	0506846	291396	267	0507107	1075005	295
0506683	5010130393	243	0506847	42003432	110	0507108	1075006	295
0506684	5010294288	242	0506848	42042950	116	0507109	1626494	288, 415
0506685	5010294289	242	0506851	2454629	112	0507111	1075663	294
0506686	5010130456	244	0506854	2461519	113	0507112	1075153	297
0506687	5010229242	244	0506855	42001326	115	0507113	1628636	297
0506688	5010130344	241	0506856	42043293	113	0507114	1080786	294
0506689	0023123262	240	0506858	2519077	113	0507115	6790572	296
0506690	5000541230	243	0506860	2444423	114	0507116	3124480	299
0506691	5010239387	246	0506869	1304571	268	0507117	1071169	292
0506692	5010207725	397	0506881	2443499	109	0507118	1071344	296
0506693	5000932435	245, 397	0506887	8590435	112	0507119	1094912	292
0506694	5000998430	397	0506888	345124	268	0507120	1075664	295
0506695	5000786902	238	0506889	352635	269	0507121	6799189	297
0506697	5000613837	236	0506893	80003408	115	0507122	1071315	298
0506699	5000446681	236	0506894	98446354	116	0507123	320	
0506709	4665085	103	0506897	41016958	114	0507124	3962343	289
0506710	4665209	103	0506904	5010097562	236	0507126	002765	325
0506711	4665501	103	0506904	86012923	108	0507127	004909	325
0506712	4520694	102	0506913	390784	268	0507128	004908	325
0506714	4692686	103	0506914	291398	267	0507129	002763	325
0506716	4699246	118	0506915	4815933	118	0507130	004729	325
0506717	4699305	117	0506916	1308643	270	0507131	065475	325
0506720	4624032	104	0506918	306981	269	0507132	000218	325
0506721	4667156	104	0506919	370875	268	0507133	043102	326
0506723	4666933	104	0506920	1379071	270	0507134	000221	325
0506725	8557536	112	0506927	41016964	112	0507138	3004600405	364, 386
0506726	8591222	114	0506928	42211148	114	0507139	3004600605	363, 386
0506728	8558540	113	0506931	41005463	116, 330	0507140	3004600205	362
0506733	8526148	102	0506932	41005450	110	0507141	3574601005	364

OCAP	O.E.	PAG.	OCAP	O.E.	PAG.	OCAP	O.E.	PAG.
0507142	3574601205	364	0507409	81466116004	157	0507614	0034605705	189
0507143	3734601005	364	0507410	36466106012	346	0507615	0024604905	195
0507144	3563300103	362	0507421	6273300103	359	0507616	3573300503	361
0507153	8558653	103	0507422	3574602405	364	0507617	4054600005	187
0507154	4546822	103	0507423	6273300203	359	0507618	4243300303	178
0507155	7136367	104	0507424	6344600505	359	0507619	3573301103	360
0507161	4722108	117	0507425	4103300303	359	0507620	3583300703	181
0507163	61595957	119	0507426	3574603205	363	0507621	3524606705	185
0507164	8573757	112	0507427	6264600005	365	0507624	6704602805	36, 184, 362
0507165	4741171	142	0507428	4103300205	363	0507625	3164600805	185
0507167	4557357	330	0507429	6273300303	359	0507626	6174602805	192
0507168	4668771	331	0507430	6284600305	363	0507627	0004609805	196
0507169	4704239	330	0507431	3574603505	365	0507628	0004604405	198
0507170	42019074	330	0507432	6284600205	365	0507629	0004609305	192
0507171	8533963	102	0507433	0003201232	359	0507630	0024604405	193
0507188	1369917	266	0507434	0034606005	195	0507631	0024604805	193
0507189	470272	407	0507435	3823300403	361	0507632	0024606405	191
0507192	4626261	128	0507436	9493301003	180	0507633	9423300203	182
0507202	5000395435	240	0507437	6253303203	179	0507636	4253300003	178
0507204	81466106648	346	0507438	3564600205	364	0507637	0034605105	196
0507207	41032826	119	0507439	9724601405	189	0507639	6764601905	188
0507212	81466106606	346	0507440	0014605305	186	0507640	6254602505	192
0507214	81466106241	155	0507441	0014604905	195	0507641	0004606605	198
0507215	85466106019	154	0507468	120322809	384	0507642	0034601805	194
0507216	81467106436	155	0507469	120322812	385	0507643	9413300103	182
0507217	85461106141	152	0507470	120323000	386	0507644	3573300803	360
0507218	3853301303	181	0507471	120324500	385	0507645	3574601405	364
0507220	5010488146	244	0507472	120325500	386	0507647	3433300303	178
0507221	20443062	320	0507473	120325800	384	0507651	9453300503	178
0507222	3112122	292, 416	0507474	120328300	384	0507652	3093301903	199, 365
0507223	3112273	416	0507477	122350000	386	0507653	6693300403	38
0507224	3112050	288, 415	0507479	122351500	386	0507653	6703300203	180, 360
0507242	305317	286	0507480	122351600	386	0507654	3023301803	360
0507243	1427727	286	0507481	122352700	384	0507655	3523302303	181
0507244	1135630	299	0507482	122352720	384	0507656	6684601705	185
0507245	1588018	291	0507483	122352740	384	0507656	6684601905	37, 39
0507253	213123269	241	0507492	0094037	83	0507657	3853301403	180, 360
0507284	42088124	119	0507494	0094053	84	0507658	3933300303	180
0507287	41016961	114	0507495	0098726	83	0507659	6704602605	35, 184, 362
0507288	8165309	111	0507533	85466106140	153	0507660	6684600905	37, 39, 185
0507290	8582320	108	0507534	81467106316	148, 343	0507661	3734600905	186, 362
0507293	41005475	116	0507537	85466106144	154	0507662	3524605505	185
0507301	42035419	115	0507549	81466116017	346	0507663	3524605805	186
0507302	42037032	109	0507552	504092614	142	0507664	3434601405	187
0507303	42039631	118	0507559	85466106143	154	0507665	3464600005	187
0507306	42043295	112	0507574	504092613	142	0507666	6174603505	192
0507309	42087846	117	0507581	81467116726	150	0507667	3734600705	363
0507310	42087848	117	0507584	0024605305	196	0507669	3463303903	179
0507312	42102633	109	0507587	0014601505	187	0507670	6204602405	196
0507314	42118694	119	0507590	6204602905	191	0507671	3874601505	191
0507321	80003410	114	0507591	6253302403	180	0507673	5010130451	245
0507323	86012924	108	0507592	6174603405	190	0507674	5010144554	245
0507335	98484091	142	0507593	6203300503	182	0507677	5001855163	242
0507347	42023779	114	0507594	0014600305	189	0507678	5010207724	397
0507365	5801282537	116	0507600	3563300003	359	0507679	1134840	299
0507366	41032608	108	0507603	9493300603	182	0507680	1626672	292
0507367	500336085	115, 330	0507604	9493300403	182	0507681	6790474	295
0507368	504049893	115	0507605	3813300503	181	0507683	8132373	299
0507369	500397738	117	0507606	3134600005	362	0507685	3574602005	364
0507370	41215165	116	0507607	3524607105	185	0507685	81466106375	346
0507371	8166702	119	0507608	6674601605	39, 185	0507686	20490120	416
0507405	81467106926	148	0507610	3913300603	178	0507688	20393069	295
0507406	81466116006	157	0507611	4244600305	193	0507692	1197338	416
0507407	81467116765	342	0507612	4254600105	197	0507693	1083744	293
0507408	81466106809	155	0507613	9704600905	189	0507694	0004604105	198

OCAP	O.E.	PAG.	OCAP	O.E.	PAG.	OCAP	O.E.	PAG.
0507695	0014602105	190	0507789	0024604505	195	0507863	20709844	299
0507696	3834606605	195	0507790	6763300703	179, 360	0507863	5010488167	244
0507697	3914601705	199	0507791	81466116045	345, 386	0507864	5010566049	236
0507698	6224600905	187	0507792	6763300803	178, 360	0507865	5010439023	237
0507700	6254601405	199	0507793	3853301603	181	0507866	504034521	119
0507701	6764601205	188	0507794	6764603105	188	0507884	5010488464	240
0507702	1088985	291	0507795	6173300203	180	0507886	9423300303	182
0507703	1612779	300	0507798	0890991	79	0507887	0034604605	195
0507704	1612857	300	0507799	0094613	83	0507888	5010199642	339, 402
0507705	1612858	300	0507800	1286342	77	0507893	500336364	142
0507706	1612781	291	0507802	6790607	296	0507894	81467116715	343
0507707	6771112	299	0507804	6194605305	190	0507895	1626671	299
0507708	1080792	288	0507805	6204603805	194	0507896	416159	413
0507709	6853511	288	0507806	81467106877	342	0507898	6704600905	37
0507710	6852197	298	0507807	81467106353	150	0507898	6704602205	185, 362
0507712	6876948	296	0507808	81467106904	149	0507904	41028269	115
0507713	6866174	291	0507809	81466106711	345	0507905	6674601505	39
0507714	6866175	291	0507810	81466106603	157	0507910	6253301203	179
0507715	6771120	299	0507811	81467116722	343	0507911	0014601305	198
0507716	1571862	288	0507812	85466106246	154	0507912	0024605205	194
0507717	6790473	295	0507813	85466106247	153	0507915	81467116773	150
0507718	1626670	293	0507814	81467116803	150	0507916	9453300003	182
0507719	1194390	415	0507815	81466106692	155	0507917	81466106836	155
0507720	1094334	292	0507816	81467106409	148	0507918	20443061	320
0507723	1395614	270	0507817	81467106912	149, 343	0507924	S009593	79, 266, 325
0507725	310977	265	0507818	81466106305	152, 345	0507928	1405655	82
0507726	1394884	266	0507819	81467106435	148	0507930	1143319	79
0507727	382780	266	0507820	81466106790	157	0507931	1361157	77
0507728	389867	267	0507821	81466106160	153	0507932	1385498	83
0507729	1112023	268	0507822	81466106779	156	0507933	1270853	77
0507730	415400	405	0507823	81466106798	152	0507934	1337644	77
0507731	1384027	269	0507824	81467106974	343	0507935	1363858	80
0507732	388942	270	0507825	6174600105	191	0507936	1451122	85
0507733	1367628	270	0507826	6684602305	36, 38, 184	0507937	1451118	80
0507734	1367641	270	0507827	0034605905	195	0507938	1451129	80
0507735	1304569	268	0507828	6734600305	186	0507939	1385488	79
0507737	1324483	267	0507829	0014604205	196	0507940	1315530	84
0507740	5010130383	241	0507830	6704600805	36	0507941	1346489	84
0507741	5430122944	240	0507831	6674600705	37	0507942	1297572	76
0507742	3573300603	361	0507832	81467106325	148	0507943	1143322	81
0507742	81467106908	343	0507833	81467106937	149	0507944	1385490	80
0507743	81467116770	342, 384	0507835	81467106355	151	0507945	0094044	84
0507744	5001829030	397	0507839	81466106754	153	0507946	1143324	84
0507755	5010064715	242	0507840	81467106852	149, 343	0507947	1395994	82
0507758	412406	405	0507841	81467106866	150	0507948	1602821	81
0507764	421573	270	0507842	85466106012	153	0507949	1700000	77
0507765	5010130710	246	0507843	81467116711	150	0507950	81467106080	342
0507766	1343283	266	0507844	81466106167	152	0507951	81466106840	156
0507767	1343266	266	0507845	81467106438	148	0507952	36466106007	346, 387
0507768	6852196	298	0507846	81467106442	148	0507953	85466106153	156
0507769	6852195	298	0507847	81467106393	149	0507954	81467116886	342, 384
0507771	1507260	269	0507848	81466106579	148, 343	0507955	81466106374	156, 345
0507772	412405	268	0507849	5010439631	238	0507956	85466106018	155
0507775	388941	266	0507850	98473328	117, 330	0507957	81467116771	342
0507776	283768	264	0507851	98493054	115	0507958	81466106159	152
0507777	283766	264	0507852	500362533	119, 331	0507960	6684602105	36, 38, 184
0507778	395347	264	0507853	500363545	119, 330	0507961	0014601105	186
0507779	1363984	264	0507854	5010294720	242	0507962	0024606105	197
0507780	388943	264	0507855	5010566059	238	0507963	0034604705	195
0507781	1300284	267	0507856	5010566064	238	0507964	0014605505	197
0507782	1305012	267	0507858	5010566063	238	0507965	0024605905	197
0507784	1257991	80	0507859	500324282	113	0507966	0034603505	187
0507786	3163300603	178, 360	0507860	8137594	110	0507967	0004609505	196
0507787	6754602605	188	0507861	5010488164	243	0507968	0014600705	194
0507788	6763301103	179	0507862	5010488165	243	0507969	9443300503	179

OCAP	O.E.	PAG.	OCAP	O.E.	PAG.	OCAP	O.E.	PAG.
0507970	0004601005	189	0508793	20375787	293	0509415	81466106813	157
0507971	0004606005	186	0508794	1610338	293	0509416	1393383	271
0507972	9574600505	190	0508795	3988764	294	0509417	81467116933	151
0507973	0024601705	194	0508796	3988767	294	0509421	504144266	111
0507974	0034604505	197	0508797	1629397	296	0509433	7420850454	259
0507975	20830369	288	0508798	3988698	297	0509435	5010630434	238
0507975	9753300203	180	0508799	20390745	297	0509436	22159757	290
0507976	4064600105	197	0508800	8190146	297	0509437	22159765	290
0507977	4608505	199	0508939	9574600405	184	0509438	1732973	77
0507978	0034603805	189	0508940	6284602005	359	0509439	20818854	300
0507979	9423300403	181	0508941	0004604005	185	0509439	5010557341	246
0507985	5010383097	243	0508942	6284601905	362	0509440	7422163636	238
0507986	5010190148	396	0508943	0004604305	186	0509441	24425658	300
0507987	5010308215	237	0508944	6754601305	186	0509442	9603300403	183
0507988	5010488097	244	0508945	3914600605	187	0509449	21119067	320
0507989	5000761673	396	0508946	6283300503	359	0509450	22318841	320
0507993	5000869763	402	0508947	6744600405	188	0509451	21176251	321
0507995	1479122	406	0508948	6224600405	188	0509452	22318844	321
0507996	1450364	405	0508949	9704600805	189	0509453	3987356	321
0507998	0466336	405	0508950	0014602505	190	0509459	1902942	85
0507999	1343262	266	0508951	6204600505	190	0509460	20727850	301
0508720	5010488051	240	0508952	3854600805	191	0509460	5001868385	246
0508721	5001868374	241	0508953	0014600505	191	0509461	0024608805	199
0508722	5010383203	241	0508954	0004604505	192	0509462	22526504	301
0508723	20727843	293	0508955	9724601005	192	0509462	7422526504	246
0508723	5010630822	241	0508956	192		0509463	20818840	301
0508724	5010037411	243	0508957	193		0509463	5010630255	247
0508725	5010557423	243	0508958	3754600605	196	0509464	1448064	85
0508726	7420761145	243	0508959	0014605105	196	0509465	22159741	301
0508727	5010039426	244	0508960	0014608605	197	0509466	22163223	301
0508728	5000453600	244	0508961	3964603005	197	0509466	7422163231	247
0508730	5010229243	244	0508962	0004604905	198	0509467	7421560848	247
0508731	5010488096	246	0508963	0014608905	198	0509468	21261985	290
0508732	5010566048	236	0508964	178		0509468	7422159764	239
0508733	5010308214	236	0508966	0014609005	199	0509469	1807596	77
0508734	5010216608	237	0508967	6253302003	179	0509470	0034608605	199
0508735	5010308083	237	0508968	0003220323	229	0509471	7421560838	247
0508736	5001868363	237	0508969	0003220423	229	0509472	22159758	290
0508737	5010347549	329, 396	0508970	0003220223	229	0509473	22159755	290
0508740	488739	413	0508971	0014606105	199	0509473	7422159755	239
0508742	1755507	404	0508995	5010294320	240	0509474	1426101	85
0508743	1433533	404	0508996	5010104287	397	0509475	22380814	301
0508744	1433532	404	0508997	5010130783	240	0509475	7422380814	247
0508745	475463	405	0508998	5010630980	240	0509477	2636650	271
0508746	1432723	405	0508999	5010383410	240	0509479	0034608005	197
0508749	1533026	405	0509350	8190147	297	0509879	1343264	270
0508751	1428193	406	0509351	20376808	297	0509880	466880	406
0508752	1497223	406	0509352	85114187	298	0509881	1348269	269
0508753	1348271	269	0509353	8154444	298	0509882	1197339	405, 416
0508754	1897669	406	0509354	20490123	416	0509884	1343278	271
0508755	1897671	406	0509355	20739082	417	0509885	1733471	270
0508756	1479120	406	0509356	20361568	288	0509886	1766014	285, 413
0508757	1388958	264	0509357	20392778	289	0509889	1766015	413
0508758	1527989	265, 404	0509358	21260275	289	0509890	1455327	413
0508759	1386618	270	0509359	20587731	289	0509891	3988708	296
0508782	70376892	425	0509360	20453063	300	0509892	85104265	416
0508783	9959503	425	0509361	20393093	300	0509893	1094219	292
0508784	20367555	291	0509370	99432053	329	0509894	20399543	290
0508785	24425411	425	0509374	7420800194	259	0509895	20393187	295
0508786	20477807	320	0509390	1408040	84	0509896	1612254	289
0508787	20443063	320	0509391	9703300003	181	0509897	20375555	295
0508788	3173914	320	0509392	22287868	413, 425	0509898	20393091	300
0508789	20374831	291	0509411	48510-F3900	234	0509899	3039647	416
0508791	9522701	416	0509412	20727840	300	0509900	8156123	289, 415
0508792	1071170	292	0509412	5001868383	246	0509901	3116050	417

OCAP	O.E.	PAG.	OCAP	O.E.	PAG.	OCAP	O.E.	PAG.
0509902	6799190	298	0581411	701419804E	70	0601905	6384600255	40
0509904	1196631	425	0581412	702419804C	70	0602230	-	60
0509905	3173613	320	0581413	701419804F	71	0602231	-	60
0509906	3112282	425	0581514	9013200389	32, 67	0602637	4000SF *	9, 17, 53
0509910	7420713859	237	0581907	6383230368	41	0602733	3812F0	11, 19, 55
0509911	22163637	289	0582743	9063201889	33, 66	0602741	-	32, 65
0509911	7422163637	237	0583812	54618-00QAA	44, 46, 58	0602741-K	9064600055	32, 65
0509912	1164684	236	0584163	6383230568	41	0602749	2992593	28, 125
0509913	488738	413	0584262	6393200189	42	0603811	-	43, 45, 57
0509914	20581086	289	0584333	7H0419804D	72	0603811-K	4501261	45
0509915	21286847	320	0585068	542180024	29	0603811-K	7701470362	57
0509916	21260274	288	0586419	4826513	329	0603867	1763991	24
0509918	504126384	329	0587871	500383975	28, 142	0604250	-	41
0509920	81466106708	345	0587980	6283201189	380	0604250-K	6394600055	41
0509930	RAK1390	76	0587981	6283201389	380	0604334	-	73
0509931	1351741	79	0587982	6283200289	380	0604424	4408474 *	48-49, 61, 63
0509932	1451119	79	0587983	6283200389	380	0604424-K	7701473333	47, 49, 61-62
0509933	0094006	79	0587990	5000450713	259	0606927	-	26
0509934	0890992	79	0587991	5010253256	259	0606927	7820249212	125
0509935	1321170	80	0587992	5010151409	402	0607191	41210795	144
0509936	1277568	81	0588741	488056	413	0607254	42072495	144
0509937	1277567	81	0588936	0003200132	380	0607552	42532977	28, 125
0509938	1406038	81	0588937	6343260116	380	0609422	42569566	125
0509939	1406600	81	0588938	6343260316	381	0683868	4059924	22
0509940	1405363	82	0589888	1506924	413	0693868	4059923	22
0509941	1401937	82	0589922	5801893542	339	0709422	5801564293	139
0509942	1407393	82	0591405	701419803C	68	0709423	5801564316	139
0509943	1405309	82	0591406	702419803A	68	0781505	9013302507	31, 67
0509944	1401932	82	0591407	701419803D	69	0781906	6383300110	40
0509945	1283203	82	0591411	701419803E	70	0782742	2E0407152M	33, 65
0509946	1395993	83	0591412	702419803C	70	0782751	6608830	21
0509947	1395995	83	0591413	702419803D	71	0783808	8200247900	48, 61
0509948	1291048	83	0591514	9013200289	32, 67	0783867	1553239	23
0509949	1306332	84	0591907	6383230268	41	0783868	1877332	24
0509950	1269973	84	0592743	9063201789	33, 66	0783869	4540774	23
0509955	1732980	76	0593812	54618-00QAB	44, 46, 58	0783870	1903526	25
0509956	1351205	76	0594163	6383230468	41	0784260	6393300510	42
0509957	1732972	76	0594262	6393200089	42	0787249	500379802	26, 139
0509958	76		0594333	7H0419803D	73	0787250	500334716	27, 140
0509959	1700001	78	0595068	542180023	29	0791505	9013301807	31, 67
0509960	1433448	84	0596419	4838587	329	0791906	6383300010	40
0509961	1396000	84	0597871	500383976	28, 142	0792742	9063304007	33, 65
0509966	81466116131	345	0597980	6283201089	380	0792751	6608832	21
0509967	81467106420	342	0597981	6283201389	380	0793808	8200247898	48, 61
0509968	153		0597982	6283200089	380	0793867	1553250	23
0509969	85466106052	154	0597983	6283200189	380	0793868	1877334	24
0509970	85466106156	154	0597990	5000450714	259	0793869	4540775	23
0509971	85466106163	154	0597991	5010253255	259	0793870	1903527	25
0509972	81466106313	345	0597992	5010151410	402	0794260	6393300410	42
0509973	154		0598741	486590	413	0797249	500379801	26, 139
0509974	81466116149	345	0598936	0003200232	380	0797250	500334717	27, 140
0509975	81466106661	156	0598937	6343260016	380	0807207	4714134	127
0509976	81466106691	156	0598938	6343260216	381	0807208	4716271	130
0509977	81466106654	346	0599888	1506925	413	0807209	42125057	126
0509978	81467106966	149	0599922	5006306003	339	0807210	4738069	335
0509979	81466106694	346	0600081	68699511	21	0807211	41042050	132
0509980	344		0600514	9750390080	13	0807213	98488010	126, 334
0509981	81467106418	157	0600516	9983325	26, 125	0807214	81432206052	162
0509982	81466116161	157	0600887	-	67	0807216	81432306037	162
0509983	81466106292	347	0600918	3812A4	11, 18, 55	0807218	6553500305	216
0509985	1395999	85	0601139	1471654080	7, 14, 51	0807219	5010094840	255
0509987	1392962	98	0601406	-	69, 71	0807221	1080690	307
0581405	701419804C	68	0601412	-	69, 71	0807222	1082104	311
0581406	702419804A	68	0601504	9014600155	31, 66	0807225	41009961	126
0581407	701419804D	68-69	0601536	4420096 Z	46, 59	0807226	41033731	126

OCAP	O.E.	PAG.	OCAP	O.E.	PAG.	OCAP	O.E.	PAG.
0807227	4865483	334	0807586	6553500006	209	0807801	81432206213	168
0807252	0023123253	255	0807587	6553500306	211	0807806	81432206164	350
0807257	4716799	130	0807590	6293500606	372	0807806	81432206215	392
0807262	42034054	128	0807591	6283330205	373	0807807	81432206174	167
0807282	4463926	129	0807592	6283330305	373	0807808	81432206145	350, 392
0807283	4719609	133	0807593	6283330405	372	0807809	81432306031	164
0807286	4855237	133	0807594	3573330405	372	0807810	81432306039	169
0807292	500340452	127	0807599	9423500505	213	0807811	81432206067	163
0807295	42065332	128	0807600	3953500806	212	0807812	81432206025	353
0807296	41028599	131	0807601	3433201632	210	0807814	81432206042	353
0807298	42034051	128	0807602	3433201732	210	0807816	81432206177	350, 391
0807299	41042093	132	0807603	3853500206	212	0807817	81432206222	169
0807308	42086282	132	0807604	6593502206	220	0807818	81432206082	169
0807326	97104296	129	0807605	6593500124	208	0807819	81432206248	350
0807328	97104299	134	0807606	3953200132	207	0807820	81432206247	162
0807336	98472871	127	0807607	3953201532	218	0807821	81432206161	162, 350, 392
0807339	99432565	334	0807608	3953200332	212	0807822	3573330205	374
0807341	99484068	335	0807610	3953201432	219	0807822	81432206185	352
0807354	082750900	391	0807611	6593501106	207	0807823	81432206151	351, 393
0807357	082751110	391	0807612	3953200206	208	0807824	81432206140	164
0807358	41035951	127	0807613	6593501406	219	0807825	3933200332	206
0807363	41218021	126	0807614	3953500606	212	0807826	3893200732	208
0807372	41218621	131	0807615	6593500427	208	0807827	3893200832	213
0807373	41272706	131	0807616	6593501206	208	0807828	3933200232	218
0807374	41296730	129	0807617	6593500406	209	0807829	6593501306	218
0807407	81432206382	163	0807618	6593501606	219	0807830	6593501506	219
0807408	81432206396	351, 392	0807619	6583500105	216	0807831	3953501206	219
0807409	81432206112	351	0807634	9423501005	214	0807832	81432206258	351, 393
0807410	81432206187	351	0807635	9453300007	222	0807833	81432206070	164
0807411	6293500006	374	0807636	9413300007	222	0807839	81432706087	166
0807412	6293501206	372	0807637	3433201832	211	0807840	81432206221	166
0807413	6273500006	372	0807638	3523500306	210	0807841	81432706137	166
0807414	3563300211	375	0807642	6533500006	206	0807842	81432706097	167
0807415	8226323000B	373	0807643	6593500106	209	0807844	81433156037	352, 393
0807416	6283330005	374	0807669	9483501205	207	0807846	81432706053	168
0807417	3173500706	374	0807670	9453300011	221	0807847	81432706055	168
0807418	3173500606	371	0807671	9413300011	221	0807848	81432206216	162
0807419	3223301011	375	0807672	3563331304	371	0807867	6543500105	217
0807420	8226232000	373	0807673	5000640089	399	0807882	3573500306	371
0807451	0477889	409	0807674	5010389262	254	0807894	81432206268	163
0807452	1438475	409	0807675	0023123275	254	0807901	1431710	409
0807453	463435	410	0807676	5010094839	255	0807906	81432206196	164
0807454	1326771	274	0807678	5010268035	254	0807907	81432706117	165
0807455	1796671	409	0807687	8158207	309	0807908	9483502205	213
0807464	082756320	392	0807690	1626958	306	0807913	7420741703	256, 310
0807478	122351400	391	0807691	1629668	306	0807914	20589061	312
0807489	0080521	92	0807738	417290	277	0807915	81432206134	352
0807501	0267743	91	0807745	0023123251	253	0807917	81432506007	169
0807507	0296110	92	0807749	5010207771	253	0807918	20443061	306
0807509	0368541	93	0807750	5010347099	399	0807927	1294251	91
0807513	0392418	92	0807752	5010005937	253	0807930	1793876	94
0807525	0649819	93	0807753	5010207726	254	0807950	81432506011	353
0807528	0658102	93	0807756	5010207727	256	0807951	81432706102	169
0807529	1576953	309	0807758	409639	278	0807984	3753500105	215
0807531	3573330101	375	0807759	416800	278	0807997	1353445	277
0807533	81432706078	165	0807760	414531	279	0808738	21051052	306
0807542	3573330905	373	0807761	416524	276	0808738	7421051052	253
0807544	1606552	307	0807762	1076639	311	0808739	5010347403	399
0807551	5000810038	254	0807762	7420829503	256	0808747	5006172093	399
0807554	466801	277	0807770	6777705	306	0808748	6443500305	374
0807555	1261101	91	0807771	1399180	274	0808750	0003301107	371
0807556	3813500206	211	0807772	445634	278	0808760	1486758	274
0807559	81432206129	163	0807773	445632	279	0808761	1770730	274
0807579	42041107	128	0807774	9483500405	215	0808762	1486756	274
0807585	6523500306	206	0807797	1284860	91	0808763	1499474	274

OCAP	O.E.	PAG.	OCAP	O.E.	PAG.	OCAP	O.E.	PAG.
0808764	1485758	275	0809909	20502944	308	0907260	93194458	335, 337
0808765	1500572	275	0809917	307		0907262	2983125	128-129, 135
0808766	1499475	275	0809921	5006305888	335	0907263	5000336305	262
0808767	1388436	275	0809924	5006305892	334	0907264	5000793641	262
0808768	1499477	276	0809925	5006305890	334	0907296	1252284	96
0808769	1399019	276	0809988	165		0907296	274070	311, 317
0808770	1485760	276	0809989	85432706001	167	0907296	93161960	132, 135
0808771	1499479	277	0858054	542180020	29	0907297	1376730	96
0808772	1431472	409	0858055	5006306531	339	0907297	3093469	318, 423
0808773	1324889	410	0888977	3573330505	372	0907297	93161958	131-132, 135
0808774	0475087	277	0888988	3563301510	375	0907299	93161631	132, 136
0808775	0481959	410	0898977	3573330705	372	0907304	0003500613	206, 208-209, 212, 216, 219-220, 225
0808776	1101843	279	0898988	3563301410	376	0907304	0691703	96
0808777	410		0900449	9945837	7, 15, 51	0907304	274068	308, 317
0808972	6533500606	206	0900489	9946982	7, 14, 51	0907304	93192618	128, 136
0808973	6273500206	371	0901169	-	13	0907327	0003300207	377
0808974	6283331105	371	0901504	9014605500	31, 40, 66	0907327	0067354	92-93, 95
0808975	9453500105	213	0901527	-	14	0907327	93192361	126-127, 131, 134-135, 336-337
0808976	6543500406	220	0901528	-	14	0907330	0003500413	207, 212, 218-219, 225
0808978	3573301911	374	0901536	4420096	46, 58	0907330	81432706045	172, 354
0808979	3573330101	375	0902079	-	67	0907330	93192619	126, 128, 136
0808980	9443500405	214	0902230	-	60	0907331	93194457	337
0808981	9423500905	214	0902231	-	60	0907339	42535445	334, 337
0808982	9483502905	215	0902637	406686	9, 17, 53	0907339	81432206213	168, 172
0808983	6533500305	217	0902733	406683	12, 20, 56	0907359	0691709	91, 96
0808984	6533500405	217	0902741	9064600096	32, 65	0907359	274019	306, 310, 317
0808985	9483502805	220	0902749	2992592	28	0907359	81432206203	352
0808986	9483500905	221	0903144	504039506	27	0907362	0003500906	377
0808987	9743500005	221	0903144	504039506 *	140	0907362	1435944	409, 411-412
0809362	1135429	420	0903807	4408476	48-49, 61, 63	0907362	5001850588	337, 393-394
0809363	24426046	420	0903811	4501260	46, 59	0907362	81432706127	351, 354
0809364	9523794	420	0903870	3736028	23	0907405	275988	317
0809365	9523795	420	0907201	0003501505	223	0907405	639319	283, 410, 412
0809366	1071674	306	0907210	-	335	0907405	81432206202	162, 172, 307
0809367	8074268	306	0907216	7701011267	257	0907406	3133173	308, 319
0809368	20816966	420	0907216	81432306043	162, 164, 169, 171	0907406	5001014520	257
0809369	1608151	307	0907217	0003300107	375, 378	0907406	81.43270.6065	168, 172
0809371	1620497	309	0907217	81432306060	355	0907407	0003302011	371, 377
0809372	20510773	421	0907219	5001842337	254-255, 258	0907407	500333284	135
0809373	1135427	421	0907222	1598588	311-312, 317, 420-423	0907407	85.43220.6002	163, 170, 172
0809375	1589817	311, 421	0907224	1135080	311, 317, 420-421, 423	0907407	85432206002	350, 354, 394
0809376	20837990	421	0907230	1498131	274-275, 282	0907409	81432206204	351-352, 354
0809377	1606551	311	0907230	504001436	135	0907414	0003501305	375, 378
0809378	20410053	314	0907230	81432706089	171	0907484	-	391, 394
0809379	20556492	309	0907252	5010014345	254-255, 257	0907485	-	392, 394
0809381	20491771	310	0907257	0691704	96	0907487	0069600	92
0809382	20556488	310	0907257	082750905	392, 394	0907487	271188	308, 313, 318
0809383	312		0907257	271188	318	0907487	2968454	136
0809384	20556493	312	0907257	2968454	129-130, 135	0907489	0698724	92, 94-95
0809385	20556491	313	0907258	1271124	91	0907508	1208073	92-93, 95
0809386	20556490	313	0907258	2980884	127, 129-130, 133, 135, 335	0907508	550807	277, 282
0809387	24426048	421	0907258	81432206108	163-164, 167, 171	0907525	0696320	93-95
0809388	1194631	422	0907259	0003500506	372-374, 377	0907528	0003300707	372-373, 375, 378
0809418	93163964	134	0907259	0689749	92, 96	0907528	0689748	93, 95
0809420	81432206327	170	0907259	070550504	392-394	0907528	271187	307-308, 314, 318, 421, 423
0809434	1722582	280	0907259	1104335	410, 412	0907528	639370	274-276, 279, 282, 409-410, 412
0809443	20448089	316	0907259	42488722	127, 136, 334-335, 337	0907528	81432306051	169, 172, 354
0809443	7420448089	256	0907259	5001842823	254, 257, 399-400	0907529	0696321	94, 96
0809444	9603500906	222	0907259	638862	276-279, 283	0907529	1104336	282
0809445	21196798	316	0907259	81432206055	162-164, 171, 350-354	0907529	274056	309, 313, 317
0809446	81432206270	170						
0809448	41272428	134						
0809879	489986	410						
0809907	3172829	313						
0809908	1590068	308						

OCAP	O.E.	PAG.	OCAP	O.E.	PAG.	OCAP	O.E.	PAG.
0907531	0003300107	377	0907773	639288	279, 282			395
0907531	0003501013	212, 224	0907774	0003502405	215-216, 225	0909990	81432710027	171
0907531	0689747	93, 96	0907774	41272706	134	0909991	81953020077	355
0907531	638861	278-279, 282	0907774	41272706 Z	129, 131, 135	0909992	81432206285	170, 173
0907533	273706	309, 318	0907774	81432706110	166-167, 173	0909993	81964010152	173
0907533	81953016132	165-166, 168, 171	0907816	81432206177 *	350, 354, 391, 395	0909994	20702095	306, 309, 319
0907534	273375	318				0909994	7420702095	253, 258
0907534	81953016133	165, 172	0907820	81432206322	162, 173	0909994	81432206241	173
0907541	0003500113	219, 225	0907836	0005860732	210, 224	0927221	20751021	323
0907545	274069	308, 315	0907840	0003504805	214, 224	0927364	145	
0907547	0003502705	207, 213, 224	0907840	81432706126	166, 173	0927365	145	
0907556	-	391, 394	0907844	81433150009	352, 354, 393, 395	0927378	145	
0907556	0003500213	206-209, 211, 213, 216-220, 225	0907845	5001847026	399-400	0927379	145	
0907556	0693778	91, 95	0907845	81432706133	353-354, 393-394	0927380	145	
0907578	93161371	126	0907846	81432706091	168, 172	0927381	146	
0907583	42530929	336-337	0907882	0003300080	371, 377	0927382	146	
0907584	0003500405	216-217, 223	0907883	0003301611	371, 377	0927383	146	
0907586	0005861533	91, 126, 136, 206-213, 217-220, 224, 391, 394	0907906	0003501513	371, 377	0927387	146	
0907586	093161371	335	0907906	81432206250	164, 171	0927388	147	
0907591	0003302111	373, 377	0907907	0003502805	224	0927391	147	
0907591	550800	274, 278-279, 282	0907907	81432706105	166-167, 169, 172	0927392	147	
0907595	5000819413	254-255, 257	0907908	0003503605	213, 220-221, 225	0927393	147	
0907599	0003502505	214-216, 223	0907909	0003503705	213, 220-221, 224	0927398	0206137	100
0907601	3435860032	210-211, 223	0907913	20741710	318	0927399	0100873	100
0907602	0005860632	210-211, 224	0907913	7420741710	256-257, 310	0927400	0548588	100
0907609	0003502205	223	0907917	3090015	319	0927401	0118086	100
0907620	0003500205	223	0907917	81432506009	169, 173, 306	0927402	0681621	100
0907621	0005861035	223	0907919	1515981	275, 283	0927403	0681706	100
0907622	0003502105	215, 221, 225	0907919	20547286	319	0927404	0681511	100
0907623	283		0907919	7420547286	256-257, 310	0927406	81.44205.6009	175, 357
0907623	0003501905	220, 225	0907919	81432706119	165, 171	0927408	81.44205.6013	175, 357
0907623	082751027	394	0907925	216,	223	0927409	-	175
0907634	0003502305	214, 224	0907925	1445656	95	0927409	3463320106	230
0907634	1515191600	167, 173	0907926	1398368	95	0927410	-	175
0907635	0003301411	221-223	0907927	0003300511	224	0927410	3465860133	230
0907638	0005860132	210, 223	0907927	1321936	92, 95	0927411	6113300019	230
0907671	0003310017	221, 225	0907927	93163617	136	0927412	6013300019	230
0907672	0003501005	371, 377	0907931	1376728	96	0927416	3103301219	230
0907676	5001823280	255, 258	0907932	1376729	97	0927419	6753300119	230
0907677	5001823279	255, 258	0907932	81432706100	167, 173	0927420	6753300019	231
0907678	5000802123	254, 257	0907950	81432506017	353-354	0927432	3553300319	231, 382
0907683	276191	307, 317	0907984	0003502005	215, 222, 224	0927436	3913300019	231, 382
0907683	81432706080	173	0907997	1243618	95	0927437	3463300019	231
0907686	276192	307, 318	0907997	550808	277, 283	0927438	3463300119	231
0907686	696321	96	0908763	1722753	274-277, 282	0927440	6253300119	231
0907686	81432706079	168, 173	0908778	1386753	282	0927441	6253300219	231
0907722	165,	171, 318	0908778	70371217	317	0927443	5000794320	261
0907739	5001842337 *	255, 258	0908978	0003300075	374, 378	0927444	5000793849	261
0907745	-	253, 258	0908983	0003501405	217-218, 226	0927445	5000794319	261
0907746	-	253, 257	0908988	0003300410	375-376, 378	0927446	5000793828	262
0907747	-	253, 258	0908989	0003302511	377	0927447	5000794318	262
0907748	-	253, 258	0908990	0003502605	225	0927450	-	262, 403
0907749	5000819365	253-254, 256-257	0908991	0003503105	225	0927452	550732	287, 414
0907757	- 91, 127, 129-130, 133, 135, 163-164,	171	0908992	0003500905	378	0927453	550730	287, 414
0907759	639299	278, 282	0909363	3093467	420-423	0927454	550257	287
0907761	638870	276, 282	0909379	1075255	309, 311-313, 319, 422-423	0927455	550284	287
0907762	3090712	256, 258, 312, 318	0909380	1628107	309, 311-313, 319	0927456	3090267	323, 427
0907763	3093631	312, 317	0909389	20840820	319	0927458	3090266	323, 427
0907763	7420840815	256, 258	0909422	5801564281	136, 139	0927742	81.44205.6016	175
0907770	3090015	306, 315	0909434	1444472	280, 283	0983868	4059922	22
0907770	81432506009	172	0909447	1676776	97	0993868	4059921	22
			0909909	3090452	308, 310, 317	1211063	9750000380	13
			0909984	81432206224 *	350, 354, 391,	1211064	9750000280	13
						1211073	61600701	21
						1211123	7700706007	60

OCAP	O.E.	PAG.	OCAP	O.E.	PAG.	OCAP	O.E.	PAG.
1211128	7700680852	60	1216302	81437220062	176			
1211142	251419831A	67	1216303	81437040074	176			
1211165	6869950	21	1216304	81962100450	176			
1211267	7700774566	60	1216305	81437220063	176			
1211310	9946982	7, 14, 51	1216306	81437040077	176			
1211392	4501260 Z	46, 57, 59	1216307	5006305917	341			
1211400	2D0422831	31, 40, 66	1216308	500345518	341			
1211430	7H0422831	73	1216312	0366351	101			
1211477	406683 *	12, 19, 56	1216313	0371586	101			
1211481	-	32, 65	1216314	0281007	101			
1211482	-	28	1216318	81960200286	176			
1211589	4408476 *	48, 50, 63	1216319	81437220059	176			
1214105	701411041	70, 72	1216329	81437040057	176			
1214109	7D0411045	70, 72	1216330	81437220019	176			
1214127	251411041C	68	1216331	81432710046	176			
1214270	701411041D	70, 72	1216332	81962100447	358			
1214276	7D1411041	70, 72	1216333	81437040061	176			
1214293	81962100278	177	1216334	81432710081	176			
1214294	81437040029	177	1216335	81442040020	358			
1214295	81437040025	177	1216337	9413230050	232			
1215173	-	11, 19, 55	1216338	9423260050	232			
1215174	-	11, 19, 55	1216339	3963260081	383			
1215175	-	11, 19, 55	1216341	9603232285	232			
1215176	-	9, 16, 53	1216342	9603231085	232			
1215177	-	9, 16, 53	1216343	9603233785	232			
1215269	93807641	27	1216344	9603232085	232			
1215270	93807640	27	1216345	9603231285	232			
1215271	93810239	27	1216346	9603172112	232			
1215388	4339248	14	1216347	9603172212	232			
1215491	1300720080	17	1216349	3028448	324, 428			
1215503	-	41	1216350	3028448	324			
1215504	-	41	1216351	3028448	324			
1215609	7700302122	43, 45, 58	1216352	1075180	324			
1215610	7700302123	43, 45, 58	1216353	1075179	324			
1215640	8200002868	48-50, 61-63	1216354	1624605	324			
1215641	8200002869	48-50, 62-63	1216355	1134955	324			
1215646	12,	20	1249734	20443059	324			
1215646	-	56	1249735	1629553	324			
1215647	12,	20	1249735	7420390836	263			
1215647	-	56						
1215659	701407087	68						
1215660	701407077A	69, 72						
1215661	7D0407183	69, 72						
1215662	701501131	70, 72						
1215663	7D0407140A	70, 72						
1215671	-	70, 72						
1215677	-	23						
1215678	4131788	23						
1215704	6393330214	42						
1215705	9013330214	32, 67						
1215817	6013210350	33, 66						
1215822	-	10, 18, 54						
1215823	-	10, 18, 54						
1215870	12,	20						
1215870	-	56						
1215872	7H0407182A	74						
1215873	7H0407183	73						
1215874	9063330014	33, 65						
1215877	6608818	21						
1215878	6517356	21						
1215953	504039506	27, 140						
1216016	4419217 Z	47, 59						
1216017	4419218 Z	47, 59						
1216245	BK213A262AC	24-25						
1216246	BK213059A	24-25						

